

Article: 17202 of rec.radio.shortwave
Path: news.cs.tut.fi!news.funet.fi!sunic!lunic!eru.mt.luth.se!
enterpoop.mit.edu!spool.mu.edu!agate!iat.holonet.net!psinntp!psinntp!panix!
schuster
From: schuster@panix.com (Michael Schuster)
Newsgroups: rec.radio.shortwave
Subject: ICF-2010 adjustment revisited
Message-ID: <C0n3JL.6J8@panix.com>
Date: 10 Jan 93 13:16:33 GMT
Organization: Panix Public Access Internet & Unix, NYC
Lines: 104

The following is re-posted from the Fidonet shortwave echo:

01/05/93 15:08:00
From: GREG HORODECK
To: BILL OXNER
Subj: SONY 2010 FREQUENCY ADJUSTMENT
I have a Service Manual for the Sony ICF-2010 and the alignment procedure forwarded by you from Genie is partially correct and I am amazed how the original author stumbled into it just by looking at the radio. Following is the instructions taken from the manual, which leave something to be desired, since pictures of the actual circuit board are part of the procedure and are important for identifying the adjustment points.

Sync Adjustment

Note: Frequency setting may alter when adjusted with shield plate (K) removed from sync board.

Setup:

Band: AM
Mode: as directed
AM RF GAIN Control: as adequate
Frequency: as directed
MANUAL TUNE MODE: SLOW
SYNC switch: as directed

Remove shield plate (K) and connect a test lead to pin 6 (varicap voltage) for VTVM and frequency counter and reinstall shield plate (K).

(There is a picture of a PC board trace with arrows where to attach the VTVM, Frequency counter, and Oscilloscope which defy any way of being described here. There are three adjusting points; CT601 (a variable cap) which is located through a small hole in the shielded SYNC unit itself, VT1 (a pot) which is located directly next to the shielded SYNC unit

on the right, and VT2 a pot) which is on the left of the shielded SYNC unit near the corner of the printed circuit board.)

Procedure:

1. Correctly and just tune in the set to a known, stable and strong AM station in NARROW and SYNC MODE off modes.
2. Set mode to USB.
3. Adjust VT1 for a 1.5V DC VTVM reading.
4. Adjust CT601 for a zero-beat note and waveform. (There is a picture of the proper and improper oscilloscope waveforms.)
5. Turn SYNC switch on and, adjust VT2 and set it to the point at which SYNC LOWER indicator just turns off to SYNC UPPER indication.
Slowly turn VT2 back to the point at which SYNC UPPER indicator just turns off to SYNC LOWER indication, and leave VT2 as is.
6. Turn MANUAL TUNING knob to obtain a frequency indication just 100 Hz above the carrier of the station being received. (only one advancement in the final digit). Now, the SYNC UPPER indicator should light.
7. Frequency counter should read 3.640 MHz + or - 100 Hz.

Refer to the original message from Gary Pupurs on Genie as forwarded to this echo by Bill Oxner for a description on how to open, precautions to take, and how to identify the SYNC unit. Since my display is spot on, I did not open up the radio to verify the colors of the pots.

The service manual is quite comprehensive and includes the owners manual instructions, disassembly instructions, adjustments and alignment procedures, voltage testpoint tables, sample waveform patterns, mounting diagram (ghost of PC board and components), schematic diagram, and parts list. It can be ordered by calling 816/891-7550 and going through the automated voices to publications. Cost was around \$10 when I got mine three years and they do charge \$3 for shipping and take plastic.

As Gary Pupurs warned, fooling around without a Service Manual is not for the faint hearted and a trip to the Sony Service Repair Center will most certainly be more costly than the Manual. I order a Service Manual as soon as I acquire any consumer electric item and they have certainly paid off.

Greg

* Origin: The Emporium BBS HST/V32/V42 708-551-9275 (1:115/551)

--

Mike Schuster

NY Pub. Access UNIX/Internet: schuster@panix.com | 70346.1745@CompuServe.COM
The Portal (R) System: schuster@shell.portal.com | MCI Mail, GENIE: MSCHUSTER

Subject: Sony 2010 SSB Adjustment

I recently got sick of listening to SSB on my Sony 2010, because it was just a bit off frequency, and I actually got better sound 100 Hz lower, for instance, 11175.9 rather than 11176.0. Now, I've been told that the BFO adjustment is detailed in the service manual, but not having it, I decided to go poking around inside anyway. Well, I found the adjustment for the BFO, and thought some of you might like to try it as well if you're in my previous position...

But first, a warning.... Poking around in your radio without a service manual can be hazardous to your future listening habits! Don't try it if you're not comfortable with taking apart your radio or don't have confidence that it will work when you are done! Otherwise, it might become time to take a trip to the closest Sony repair center. :) And of course, I am not responsible for whatever you do to your radio...

Okay, now for the description. (Now might be a good time to write down your frequencies stored in memory, if they are important...) You can disconnect power if you wish, but you'll need it later when adjusting, so it doesn't matter, really. Remove screws on back and take off the back lid. Don't forget the screw in the battery compartment. You will see a circuit board and the back of the speaker. Remove the screws in the board with arrows pointing to them and release the plastic snap-clamps along the edge of the board.

For the next step, be careful not to rip out any wires; yours might be shorter than the ones in my radio. Separate the boards enough so you can get to the bottom of the board that is now loose. Take care to avoid pulling out the ribbon cables for the keyboard--they are only held there mostly by friction. (I found out the hard way; the ribbon slipped out partially, without me noticing, and suddenly the keypad didn't work... Had me scared for a while :).)

You can see a metal case labeled 'sync unit' about 3/4"x3/8" (?) that is mounted on the board. Next to it is a blue trimmer pot, the only pot in the near vicinity of the metal case. This is the BFO adjust.

Now tune in a somewhat strong SSB frequency that can be clearly heard. Military stations are best, since their equipment is going to be more accurate than a ham radio operator's (in most cases :)). I used the GHFS frequencies. Wait until some traffic comes on and adjust the pot in VERY small increments. The pot is very sensitive, and not much turning will be needed to realign your receiver. This adjustment is best done with a non-metallic screwdriver or other instrument, since metal might temporarily affect the capacitances, inductances, etc. of the circuit, and cause it to be off frequency again once you remove the metal object. Of course, if you make small adjustments and then check it, a metal screwdriver will do the job.

After getting the receiver sound to your liking, which may take a while depending on the amount of traffic, switch to some other freqs, both USB and LSB, Ham and Military, to see if you need to make any final adjustments before closing it all up again.

Just reverse the process to get your 2010 back together. Make sure the volume, RF gain, and tone switch all align with their counterparts on the case. Best way to do this is to push them all either up or down fully. Now, hopefully, your Sony 2010 is now back on the right track, and SSB no longer has that hint of D.Duck in there!

The adjustment will also affect the SYNC setting, so if your sync LEDs didnt always light up on the correct freq, that probably is fixed now too. I think Sony should have added a 'user-servicable' pot on the back or side with a little hole in the case where an 'inclosed' screwdriver could be inserted to fine-tune the SSB without delving into the innards of the radio or taking it to a service center; are you listening Sony? :)

Does anyone know what the other blue pot is for on that board, the one that is more or less off by itself? The PCB is labeled, but there is a blob of hardened sealer gunk on mine that makes it illegible.

I really should pick up the service manual... I still want to do the mod to the tone switch. It would also be nice if there was some way for the radio to select WIDE instead of NARROW when a band is selected...oh well, can't have everything... :) It's still one heck of a radio for the price...

Date: Wed, 27 Jan 88 08:58:58 est
From: mac@idacrd.UUCP (Bob McGwier)
To: ka9q.bellcore.com!n4hy@bellcore.UUCP
Subject: 56K modem fixes

56 kilobaud modem bug report (1-10-88)

TRANSMITTER ENCODER BOARD (110386):

Some of the 110386 transmitter encoder boards have a missing trace between U10 pin 21 and pin 24. This problem exists only in the second batch of boards and was due to tape falling off the artwork. To fix it just solder a wire between U10 pin 21 and 24.

RECEIVER DECODER BOARD (021987 rev A):

There have been reports that various brands of 555 timer chips don't work well (or at all) in socket U7. I have discovered the cause of this problem. The ground side of capacitor C1 needs to be DIRECTLY connected to pin 1 of U7. You need to cut the trace that goes between component carrier N1 pin 9 and ground. Solder a wire from N1, pin 9 to U7 pin 1. All non-CMOS 555 chips should work with this mod. The next release (rev B) will have this fixed.

from Dale A. Heatherington WA4DSY

Subject: Bearcat Mods

Netlanders:

Concerning the Uniden Bearcat 760xlt, the mod for the 950xlt does work to restore lost freq. Disconnect pin 20 of the microprocessor from the circuit board and connect it to pin 19. I bent the pin slightly and cut it with the scissors of a swiss army knife then soldered an 1/8 lead cut from a cap across the pins near the top of the chip. I've yet to find any problem with this mod. But as always do so at your own risk.
73 Mike WA2E @ K2DLJ

Date: Tue, 17 May 88 17:09 EST
From: <REID@IUBACS.BITNET>
To: MBRAMWEL@BUSINESS.UWO.CDN

Subject: ICOM IC-2AT, IC-02AT Mods

Wright, Tim AL7DS: "Those Tantalizing Twos," _73_ magazine, June 1986 p. 60.

Description of modifications requires illustrations. Article has very good mod for IC-2AT, to cover portion of 150 MHz range and preserve ham band. The IC-02AT modifications are valid only for units with serial numbers below 34000.

A simpler IC-2AT mod is described in _73_, October 1981 p. 113.

--

YAESU 757GX

Lert, Peter: "Bootleg HF Radios," _IFR_ magazine, Premiere issue, 1985, p. 12.

Open the radio and flip an unmarked but quite accessible switch.

Article also describes airborne HF antennas.

--

KENWOOD 2600

West, Gordon: "All-Band Transmit Modifications," _Popular Communications_, March 1968 p. 60.

Locate the two diodes standing on end with Teflon covering the top part of their leads (which at one time were soldered together, broken, and then resoldered). Simply clip these two leads to unlock the transmitter, but be sure to reset the microprocessor by pushing the reset button before the set is capable of transmitting on any frequency at 150 MHz.

KENWOOD TS-430S

Unplug 3-wire plug on the RF board that mates with socket 10. When looking at the top front of the radio, it's to the left front side right beside a larger white plug. You'll need to carefully examine the circuit board and locate the number 10 with a circle around it to insure you have the right plug.

KENWOOD 940

Locate IC number 109. Now find diode 130 and cut it for all-band transmit. If you want just MARS coverage, locate IC 111 and 112, and snip diode 135 beside it.

KENWOOD 930

Modifiable; requires several jumper. Details not given.

ICOM IC-720

Transmitter is unlocked by snipping the light blue wire that's at the very end of the top hatch cover to the left middle side of the transceiver.

ICOM IC-735

To unlock the transmitter: cut diodes D33 and D34 that are standing on end near the microprocessor section toward the rear top of the radio.

ICOM IC-745

Locate the RF board on the side of the radio and cut the light brown wire at jack 7., which is going to pin 1. Your transmitter is now unlocked.

ICOM IC-751

Locate the RF board on the side of the radio and cut the black wire going to pin 1 of jack 2. Your transmitter is now unlocked. (This mod also described in _73_, July 1985 p. 12.)

ICOM M-700 Marine Transceiver

Despite that the literature says, no lock-out is employed. For ham frequencies on 40, 80 or 160 meters, set the mode switch to the hard left position of "A3," to enable the lower sideband filter (all marine HF uses upper sideband).

--

Frank W9MKV
bitnet: reid@iubacs
arpa: reid@gold.bacs.indiana.edu

Subject: Extended frequency rx and tx of the ALR22T & ALR22HT
ALINCO 2 METER RADIOS.

BEWARE OF ANY STATIC WHEN WORKING WITH THIS RADIO !!!

- 1 Remove the top and bottom covers of the radio.
- 2 Remove the 4 screws that hold the front panel assembly to the main chassis.
- 3 Pull front panel away from the main chassis very gently.
- 4 Locate the Volumepot on the left side of the radio.
- 5 Locate the VFO control on the left side of the radio.
- 6 Between the two above units is an IC that runs vertically between the two units. (ONLY THE 12 PINS OF THE IC ARE SEEN FROM THE BACK)
- 7 After locating the IC locate 3 sets of unsoldered jumper pads between the IC pins.
- 8 Make a solder bridge between the top 2 pads, then the middle 2 pads, then between the bottom 2 ONLY of the bottom set of 3 pads.

REAR VIEW OF FRONT PANEL

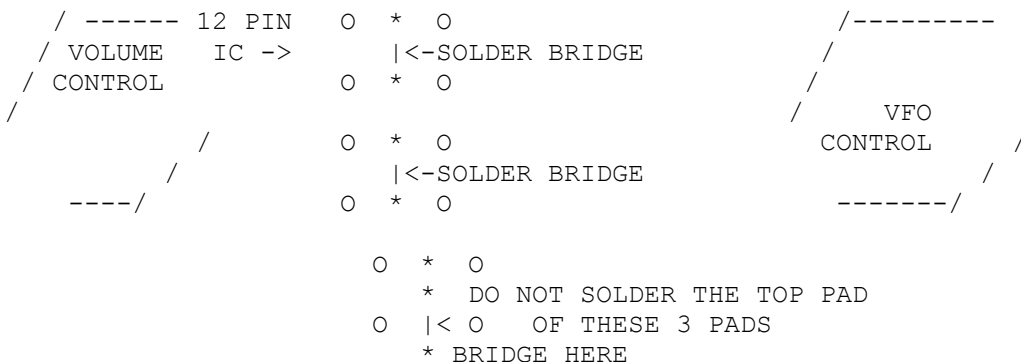

- 9 RE-ASSEMBLE RADIO .
- 10 RESET MICROPROCESSOR.
- 11 This mod will extend the RX range as well as the TX range of the above unit. The display will have a range from 29mhz to 299 mhz but this is just an erroneous display as the PLL on a typical radio will rx between 130 mhz and 180mhz with a TX range that may be a little beyond these these frequencies.

GOOD LUCK AND HAPPY MODING

73 CARL

Packet: VE3ZCO@VE3GYQ

Internet: VE3ZCO@ardsley.business.uwo.ca

CARL VE3ZCO [44.135.80.8]

From news.cs.tut.fi!news.funet.fi!news.tele.fi!sunic!psinntp!psinntp!panix!
schuster Fri Apr 30 14:09:32 EET DST 1993
Article: 19882 of rec.radio.shortwave
Xref: news.cs.tut.fi alt.radio.scanner:4399 rec.radio.shortwave:19882
Newsgroups: alt.radio.scanner,rec.radio.shortwave
Path: news.cs.tut.fi!news.funet.fi!news.tele.fi!sunic!psinntp!psinntp!panix!
schuster
From: schuster@panix.com (Michael Schuster)
Subject: Review: AOR AR-1500 handheld scanner
Message-ID: <C69rMB.Eu2@panix.com>
Reply-To: 76174.637@CompuServe.COM
Organization: PANIX Public Access Unix, NYC
Date: Thu, 29 Apr 1993 23:51:47 GMT
Lines: 318

Perhaps because of rapidly changing laws regarding full coverage scanners, these radios are generating a lot of interest lately. One of these models is the AR1500 handheld. The attached review was written by Howard Bornstein, author of the "Guide To The AR1000" guidebook. It is re-posted here by permission of the author.

=====

PRODUCT REVIEW

AOR AR1500 continuous coverage handheld scanning receiver with SSB.

by
Howard Bornstein
Copyright 1/25/93

This is a review of the new AR1500 continuous coverage handheld scanner from AOR. Consider this review to be preliminary, since it was conducted on a unit I had available over a weekend and does not reflect long-term usage. In this review, I will be comparing the AR1500 to the AR1000 and the Radio Shack PRO-43, two other scanners I am very familiar with (I am the author of the Guide to the AR1000, and the upcoming Guide to the PRO-43).

VERSIONS

There are three versions of the AR1500 known at this time. The original AR1500 was released and available in Japan, the UK, and Europe in mid 1992 and was known simply as the AR1500. A later revision to this scanner appeared in late 1992, called the AR1500E. This model differs from the earlier model by including a cascade filter at 58.075 MHz IF to improve selectivity, a DC input protection diode to guard against reverse polarity connection, additional buffering in the microprocessor to protect against software crashes when scanning an empty bank, and a reset switch in the battery compartment.

A new revision, called the AR1500EX, will be available on Feb. 9, 1993 only in the UK. It contains a substantial redesign of the PC boards and logic circuits. The RF board has been completely redone. In addition, the BNC connector has been reinforced. The unit is supposed to have better selectivity and better handling of strong signals.

This review was conducted on an AR1500E that was imported in the US from ACE Communications. My thanks go to Glenn Cohen of Scanner's Unlimited for the loan of this unit for testing.

FEATURES

The AR1500 is a very feature-laden scanning receiver. It's main features are:

- o 900 general channels of non-volatile scan memory. (100 channels dedicated for search and store feature).
- o 10 individual search banks. (Bank 9 dedicated to search and store)
- o Reception in FM, wide FM, and AM modes.
- o Contains a beat frequency oscillator (BFO) for reception of single side-band (SSB) and continuous wave (CW or Morse) signals. It can receive both upper side-band (USB) and lower side-band (LSB) transmissions.
- o Continuous coverage from 500 KHz to 1300 MHz with no gaps.
- o Searches and scans at 20 channels per second.
- o Any channel can be the priority channel which is active in search, scan, or manual mode.
- o Search increment is user-selectable in any steps of 5 KHz and 12.5 KHz up to 995 KHz.
- o Tuning knob.
- o Channels, scan banks, and search banks may be locked out. Also, individual frequencies during a search may be locked out.
- o 10 db attenuation switch
- o Automatic search and store function.
- o Delay or Hold feature.

SIZE

The AR1500 is a fairly small scanner, much smaller than the AR1000 and about the same size as the PRO-43. It is about 1/2 inch taller than the AR900. Both the buttons and the display are smaller than the AR1000, as is the speaker.

There is a trend with current scanners to make them smaller, but there seems to be diminishing returns in this endeavor. The AR1500 is small enough to be a problem for some people. For someone with large hands, the small buttons may create difficulties in programming. There are also many controls crammed on the top of the scanner (see below). In particular, it is quite difficult to turn the unit on and off and adjust the volume because the On/Off/volume knob is crammed in between the BNC connector and the Squelch/BFO knob. This makes it very difficult to get your fingers around the On/Off knob to turn it.

Other negative side-effects of the small size are the smaller, lower-fidelity speaker, and the smaller battery pack, reducing operation time.

CONTROLS

The top of the unit contains a number of knobs and switches. You'll find the BNC connector, an On/Off/Volume knob, a ganged BFO/Squelch knob, a tuning knob, a BFO button, a 10 db attenuator button, and earphone jack, and a pushbutton switch for keylock.

The display and the keyboard are the same as the AR1000, although some of the keys are in different positions (e.g. BANK and INC are reversed on the AR1500 and INC is now called STEP).

Sound quality is good and the unit can be turned to full volume without distortion, but the speaker doesn't give the same high-fidelity sound as is found on the AR1000.

ACCESSORIES

The AR1500 in the US comes with its built-in nicad pack, a AAA battery holder, a rubber ducky antenna, a 5 meter wire antenna with a BNC connector on one end for HF reception, a cigarette lighter adapter, and AC charger, a soft case and a single ear earphone.

Note that the AC charger is not designed to operate the unit but to simply charge the batteries while the unit is turned off. If you want to use the scanner while plugged in (which you will, since the battery life is short), you will have to purchase a separate AC adaptor. The Radio Shack 12 VDC 500 mA adaptor (CAT No. 273-1652B) works fine for this.

OPERATION

The AR1500 operates essentially the same as the AR1000. This is to say that it uses a somewhat cumbersome programming scheme. Users of the Uniden BearCat series of scanners and the Radio Shack/GRE PRO series of scanners will find the AR1500 operations to be tedious.

Of more concern is that the operation of the AR1500 was modified slightly-- in some cases to handle the new search and store feature and in others to simply "improve" the operations. However, many of the special tricks and shortcuts that were possible on the AR1000 (and described in the Guide to the AR1000) no longer work on the AR1500. While learning how to use the AR1500 is not all that difficult, it requires more time than most scanners and more consultation with the user documentation.

An interesting difference between the AR1500 and the AR1000 is that every keystroke you enter on the AR1500 generates an audible beep for feedback. This capability is also found on some of the Fairmate versions of the AR1000 (i.e. the HP100 and HP200). On the AR1000, there is no keystroke beep.

USER'S MANUAL

The AR1500, as supplied in the United States, comes with a 19 page user's manual. This manual briefly describes the keys, the controls, and the basic operations, but doesn't go into much detail about how to take advantage of the power of this scanner. In addition, there are some serious errors in the documentation, particularly in the examples. As stated above, the Guide to the AR1000, while covering all the basic operations of the AR1500 (minus the BFO and search and store feature), addresses many tricks and shortcuts that are not applicable to the AR1500. As a result, the Guide to the AR1000 is not primarily recommended to owners of the AR1500.

The user's manual for the AR1500 available in Australia and New Zealand is better and the manual produced by AOR Ltd. in the UK is the best.

PERFORMANCE

The following characteristics are based on my subjective analysis during usage and not on laboratory tests. They may be specific to my location (San Francisco Bay area).

SENSITIVITY

The AR1500 is a quite sensitive receiver. It proved to be more sensitive than

the AR1000 but less sensitive than the PRO-43. It easily broke squelch on a signal that the AR1000 could only hear with the squelch opened manually. Both units were using identical DA900 rubber duckies.

Like the AR1000, the AR1500 can pick up SW and MW signals when attached to an appropriate long-wire antenna. While you wouldn't buy this unit as your primary shortwave receiver, it can pick up strong SW signals nicely (subject to signal fading) and the AR1500 can easily decode SSB signals.

INTERMODULATION

The AR1500 seems to have about the same intermod problems as the AR1000. My unit got periodic FM radio broadcast interference all across its frequency range. While it wasn't as bad as the Icom R1 is rumored to be, it was noticeable.

IMAGES

The AR1500 is supposed to be triple-converted, but I noticed images in the 800 MHz range. I picked up cellular phone conversations on the local government frequency of 812.2125 MHz. This was the only frequency I noticed images on. The AR1000 doesn't do this.

RF

The AR1500 puts out a fair amount of RFI. It stopped the PRO-43 from scanning at a distance of over 4 feet. If you are using this scanner near other scanners, you might have a problem.

BATTERY LIFE

The AR1500 comes with a custom 5 AA cell molded nicad pack. The pack is removable, but there is no way to charge the pack while out of the scanner. The scanner also comes with a battery holder that will take 4 AAA alkaline or nicad batteries. I wasn't able to do a battery test on this unit but the custom nicad pack battery life is said to be about 4 hours. The AAA battery pack life is supposed to only be about 2 hours. Any AR1500 users who have more accurate figures than this are encouraged to contact me and I will update this document to reflect these figures.

Charging time is approximately 15 hours and you are warned not to overcharge the nicad pack.

Battery life and maintenance seems to be the biggest problems with this unit. It will not be very useful in the field if you run out of juice in a few hours. And, unfortunately, you can't be charging one pack while you are using another.

SSB OPERATIONS

One of the more intriguing features of the AR1500 is the ability to decode SSB. The AR1500 includes a BFO that you can use to tune in upper or lower side-band signals. There are a number of limitations to this feature, however.

I had hoped that you could simply program in a number of utility stations and scan them in SSB. However there are a couple of things that make this impossible. First, the squelch control on the AR1500 is as squirrely as it is on the AR1000. The squelch setting is different for different bands, and in

the SW region it is practically useless. You cannot squelch out many frequencies, even if they don't appear to have an active signal or carrier. Therefore, you can't really scan these frequencies.

The second problem has to do with the resolution of the AR1500. The finest tuning increment you can select is 5 KHz. You use the BFO to tune between the 5 KHz limitations. So, for example, if you wanted to pick up 8989 KHz, you would have to enter 8990 and then tune down to 8989 with the BFO. Of course, the setting on the BFO would be different for this station than it would for 7613 (you'd have to enter 7610 or 7615 and tune in between with the BFO). What this means is even if you could scan SW stations, the BFO would be set at a different location for each station.

While I didn't try this with CB, presumably you could enter all 40 CB channels, set the BFO to USB and scan all the USB CB channels. Then, just by turning the BFO a bit, you could scan all the LSB CB channels. If any AR1500 user can confirm this, please drop me email and I'll update this document with your comments.

The unit I tested also put out an extremely high-pitched whine while tuning in the SW bands.

SEARCH AND STORE

The search and store feature provides a way to automatically take active channels that you find during a search and plug them into scan channels. The search and store feature on the AR1500 is pretty limited in its capability and usefulness. This is somewhat frustrating, especially since all of the capabilities are built into the AR1500 to have made this a much more useful feature.

Whenever you search with search bank 9, every channel it stops on is automatically plugged into the next succeeding scan channel in scan bank 9. The first signal goes into channel 900, then 901, etc until you fill up all 100 channels in scan bank 9. When you reach channel 999, the unit starts over with channel 900 again.

The way you would use this is to start searching and then later simply scan, using scan bank 9. The problem with this feature in the AR1500 is that it stores anything it stops on during a search. It will store open carriers, data channels, static, and any other kind of signals. The biggest problem, however, is that it stores the same frequencies over and over again.

This could have been eliminated and the search and store feature could have been made to be much more useful had AOR simply combined the search frequency lockout feature with the search and store feature. This way, as soon as the scanner stopped on an active frequency during a search, the frequency would be stored in scan bank 9 and be locked out of search bank 9. Then, an active frequency would only be stored once. In addition, the scanner wouldn't have to needlessly stop on channels you have already stored, making it more likely that you could catch the elusive signals in the range you are searching. Then, when you scan bank 9, you'd get all the frequencies found during your search with no repetition. Alas, it wasn't implemented this way, so IMHO the search and store feature is quite a bit less useful.

In addition, the search and store feature only stores the mode as AM or FM.

If you are searching in WFM mode, the channels get stored as FM mode, not WFM mode.

RECOMMENDATION

The AR1500 is an amazing piece of engineering, cramming incredible functionality into a very small package. Unfortunately, the small size itself may be more of a minus than a plus. It makes the unit harder to operate and gives it a considerably shorter battery life. In addition, the designers of the AR1500 didn't fix many of the idiosyncratic problems of the AR1000 when they designed this new scanner.

While the AR1500 is more sensitive than the AR1000, you lose 100 scan channels and one search bank to the dedicated function of the auto search and store--a feature which may not be of great value to most users.

You also get SSB reception, but this feature generally can't be used in scanning mode. This makes SSB reception a single station feature. Since the AR1500 isn't designed as a primary shortwave receiver, this feature should be considered a bonus, not a main selling point.

Unless you have a specific and demanding need for SSB reception, it seems hard to justify the additional expense of an AR1500 over an AR1000, especially considering its difficulty of operation due to its small size and its short battery life. However, if you are in the US and are buying the AR1500 from the UK, with the current exchange rate, you may get a price comparable to the US version of the AR1000. In this case, the trade-offs might make sense.

The AR1500 has the same intermod and squelch adjustment problems as the AR1000. In fact, the AR1500 manual from ACE carries this disclaimer in the warranty:

"We do not warrant that the operation of the unit will be uninterrupted or error free."

BOTTOM LINE:

If you want a continuous coverage scanner and don't have a pressing need for SSB reception, buy an AR1000.

Feel free to contact me with comments, confirmations, criticisms, or additional information (I'd appreciate holding off on the death threats if you don't mind!)

Howard Bornstein
76174.637@CompuServe.COM

=====

--

Mike Schuster | schuster@panix.com | 70346.1745@CompuServe.COM
----- | schuster@shell.portal.com | GENie: MSCHUSTER

From: schuster@panix.uucp (Michael Schuster)
Subject: Reprogramming the AR1000
Keywords: AR1000 AOR SCANNER RESET REPROGRAM
Date: 4 Jun 91 00:22:30 GMT
Organization: PANIX - Public Access Unix Systems of NY
Lines: 191
Xref: west rec.radio.amateur.misc:3326 rec.radio.shortwave:7938

There seems to be renewed interest in this, so I thought I'd post Lionel's article once more. After reading this I tried it on my older vintage AR1000 and successfully moved the low frequency limit from 8 to 0.5 MHz. Your mileage may vary. Anything which results from implementing the instructions below is AT YOUR OWN RISK.

Lionel copied these instructions from a factory set up sheet, sent to him by his dealer when the CPU locked up (a rare event), rendering his radio dead. It is also reproduced in the service manual, available from AOR Japan (no, I don't have the address).

=====
AR-1000 Reset Procedure
=====

* What you need :

- A small Philips screwdriver
- A soldering iron (30 W max)

* What to do :

- Remove the antenna
- Remove the batteries
- Remove the tuning, volume, and squelch buttons
- Remove the back cover (4 black screws), and disconnect it from the rest

- Lay the unit flat on the table, keyboard and display below, antenna connector away from you
- Unsolder the black wire from the lower right corner of the upper board
- Unsolder the brown wire from the upper left corner of the same board
- Remove the 3 screws that hold this board
- Pull GENTLY this board out of the upper panel (volume, squelch, and tune rods come with the board - not the antenna connector)

- Unsolder the black wire from the upper left corner of the middle board
- Unscrew the 3 copper columns that hold this board

- To get a better access on the lower board, you may wish to remove some of the connectors that link the upper and middle boards to

the power supply board (the one that hides the speaker) --- don't forget to take note of which connector goes where !!!

- Now take a look at the lower board. It looks like this :

(X) green led

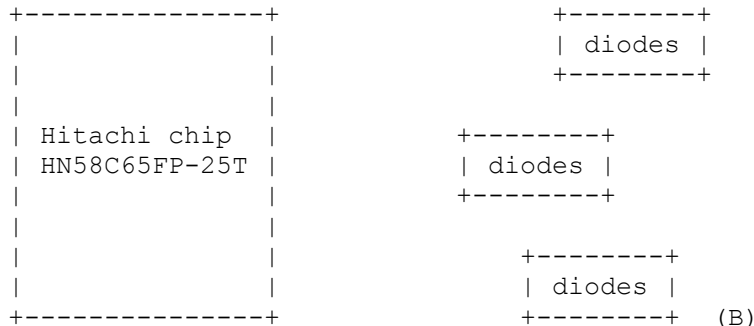
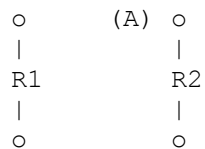

- Solder a piece of wire (wrapping wire is a good candidate) between points (A) and (B).
- Reconnect ALL wires (solder unsoldered wires and connect disconnected ones)
- Place batteries back
- Turn unit on : the display should be blank.
- Now type the following :

```
BANK
1 PROG      8 LIMIT  49.995 SEARCH 561.225 ENTER
2 PROG     50 LIMIT 107.995 SEARCH 561.225 ENTER
3 PROG    108 LIMIT 169.995 SEARCH 561.225 ENTER
4 PROG    170 LIMIT 296.995 SEARCH 561.225 ENTER
5 PROG    297 LIMIT  600     SEARCH 251.575 ENTER
6 PROG    805 LIMIT 1109995 [down arrow] 251.575 ENTER
7 PROG   1110 LIMIT 1300     [down arrow] 561.225 ENTER
```

- Turn unit off
- Unsolder the piece of wrapping wire
- Mount the unit back (wires, connectors, screws...)

- Turn unit on : it should be working !!!

* My comments :

DO NOT TRY THIS BY YOURSELF IF YOU DON'T FEEL CONFIDENT ABOUT USING A SOLDERING IRON ON SUCH A MINIATURIZED DEVICE !!!

DON'T FORGET THAT, IF YOU FAIL, THE WARRANTY WILL BE VOID !!!

Now, let's relax. From the programming procedure, it is obvious that you enter 7 sub-bands in the unit :

```

      8 to   49.995 MHz
     50 to  107.995 MHz
    108 to  169.995 MHz
    170 to  296.995 MHz
    297 to  600.000 MHz
    805 to 1109.995 MHz
   1110 to 1300.000 MHz

```

These are the values for the AR-1000 as sold in France. The values may be different for the units sold in Northern America (there may be other gaps, especially for cellular phone frequencies).

I don't know what the following parameters (561.225 and 251.575) mean. I guess they indicate which RF subcircuit, which step, and which modulation mode to use. Anyway, since the sub-bands limits appear so clearly, it might be fun to experiment. See what I mean ?

But, if we are to experiment, let's make things easier. Instead of dismounting-soldering-programming-unsoldering-mounting the unit each time, let's solder a 5" piece of wrapping wire to point (A), a 5" piece of wrapping wire to point (B). Now we have 2 free ends : let's solder a microswitch to them. We can glue the microswitch at the bottom end of the unit, near the power supply board. Resetting the AR-1000 is now much simpler : just open the unit (4 screws), flip the switch, turn the unit on, reprogram it, turn it off, flip the switch back, close the unit.

First of all, if you replace the first "8" with "0.5", you get an AR-1000 with coverage extended down to 500 kHz. This may not work on older units. My unit didn't let me program any frequency lower than 0.5 MHz, or higher than 1300 MHz. Anyway, my aim was to try to get rid of the 600-805 MHz gap. I tried the following sub-bands :

```

      0.5 -   29.995
     30.0 -  219.995
    220.0 -  409.995
    410.0 -  599.995
    600.0 -  904.995
    905.0 - 1209.995

```

1210.0 - 1300.000

To choose these values, I made the following assumptions : the original values never exceed a 190 MHz span for the "561.225" series, and never exceed a 304.995 MHz for the "251.575" series. I was careful not to exceed these ranges, because of the necessarily limited span of the internal VFO.

These values did seem to work, since I was able to hear some TV signals near 620 MHz, that is, in the previous gap ! However, when I programmed some search banks, it sometimes refused to search, even on "authorized" frequencies (around 450 MHz). And, since there is nothing but TV channels between 600 and 805 MHz (at least in France), I restored the original values (except for the 0.5 MHz lower limit).

Now, if you find something interesting, please keep me informed !

Lionel ANCELET

BIX : lanc
CompuServe : 71641,1340
INTERNET : 71641.1340@compuserve.com

--
Mike Schuster | CIS: 70346,1745
NY Public Access UNIX: ...cmcl2!panix!schuster | MCI Mail, GENIE:
The Portal (R) System: schuster@cup.portal.com | MSCHUSTER

Article: 17668 of rec.radio.shortwave
Path: news.cs.tut.fi!news.funet.fi!sunic!mcsun!Germany.EU.net!news.netmbx.de!
mailgrrz.TU-Berlin.DE!math.fu-berlin.de!ira.uka.de!yale.edu!spool.mu.edu!
howland.reston.ans.net!paladin.american.edu!gatech!rpi!utcsri!
newsflash.concordia.ca!mizar.cc.umanitoba.ca!access.usask.ca!herald.usask.ca!
maton
From: maton@herald.usask.ca (Terry Maton)
Newsgroups: rec.radio.shortwave
Subject: Radio reviews
Date: 26 Jan 1993 20:03:16 GMT
Organization: University of Saskatchewan
Lines: 34
Distribution: world
Message-ID: <1k45e4INN98d@access.usask.ca>
NNTP-Posting-Host: herald.usask.ca
Originator: maton@herald.usask.ca

The february issue of BBC Worldwide magazine includes reviews of
12 shortwave receivers.
Here are the ratings given (actually they use little radio symbols not *)

* Mediocre
** Average
*** Good
**** Very Good
***** Excellent

** Lowe SRX-50 (Amsonic AS-908 or Morphy Richards R191)
 is mOrphy a mistake - I remember mUrphy richards as a kid)
**** Sangean ATS-808 (Roberts R808, Realistic DX-380, Siemens RK661)
 in the article they wrongly say DX-390 for above)
** Sony ICF-SW20
** Sangean SG621 or SG631 (Siemens RK710 and Roberts R621)
**** Sony ICF-SW1E
*** Panasonic RF-B45 (National B-45)
**** Sony ICF-SW7600
*** Sangean ATS-818CS (Roberts RC818 and Siemens RK670)
**** Sony ICF-SW55
**** Sony ICF-SW77
***** Grundig Satellit 700
***** Lowe HF-150

You'll have to read the magazine to get the details, as price, portability,
options, etc. have a lot to do with your choice.

Terry

--

Terry Maton
University of Saskatchewan, Saskatoon, Canada

INTERNET: maton@sask.usask.ca or maton@herald.usask.ca

Newsgroups: alt.radio.scanner
From: interpol@casbah.acns.nwu.edu (Interpol)
Subject: Uniden Bearcat 200XLT Modifications
Message-ID: <1992Mar13.182158.11346@casbah.acns.nwu.edu>
Sender: interpol@nwu.edu
Organization: Northwestern University, Evanston, Illinois
Date: Fri, 13 Mar 1992 18:21:58 GMT
Lines: 80

Speeding up the scan/search rates for the Uniden BC-200/205 XLT
You will need a small crystal or ceramic resonator in the 600-800
kHz range.

1. Disassemble the unit to access the microprocessor area.
 - a. Slide off the battery pack.
 - b. Remove the two screws from the rear of the scanner and the two screws that hold the battery retaining spring at the base. Then remove the spring.
 - c. Carefully pry the bottom of the rear cover from the scanner and remove the cover.
 - d. Locate the two small screws at the base of the circuit board and remove them. Gently pull the front panel from the main frame at the base and separate them. If you separate them between the two layers. Remember that for later reassembly; the pins will have to be lined up perfectly before you slip the sections back together.
2. Search around the logic/CPU board (Uniden calls it the "MICOM PCB Assembly"), and locate Y-201, which is a little rectangular component. This is the stock 400 kHz resonator. Your replacement can be a bit larger if necessary, but not grossly so.
3. Carefully desolder and remove Y-201. Put it in safekeeping because you may want it for something else someday.
4. Install (solder) your newly procured replacement clock resonator, be it a crystal or another ceramic resonator, where Y-201 came out.
5. Reassemble: Insert top of the front panel into the slot under the volume/squelch control panel. Carefully noting the alignment of the dual in-line connector at the bottom of the board with the mating socket, press the front panel firmly into place. Be sure that the holes at the bottom of the circuit board line up two screws and tighten them
6. Replace the rear cover by inserting the top of the cover into the slot under the VOLUME/SQUELCH control panel. Press cover into place. Insert and tighten the screws.
7. Reposition the battery retaining spring (slotted side toward notched hole). Insert the two remaining screws and gently tighten them.
8. Slide the battery pack into place. Switch scanner on to

ensure that the display comes on. If not, the battery may be discharged or the dual in-line connector may have been misaligned during reassembly (step 5). Another possibility would be that the new resonator either doesn't work, is unsuitable, or may have been incorrectly installed. Another possibility (if you installed something greater than 800 kHz is that it's just too fast.

Assuming that the display comes on, leave the antenna disconnected, and run a speed test. Speed in channels-per-second equals the number of channels divided by the time in seconds. Using a Murata-Erie 800 kHz

Note that the channels must have frequencies programmed into them. "Empty" or 0000.000 MHz channels run faster and throw off the calculation.

In addition to the shortened delay time, the user reports that the panel lamp will "time out". Doubling the clock frequency halves the "light on" time. There is a variable extended delay modification in the "World Scanner Report", too large to duplicate here. Also, in Volume 1, Number 4, Bill Cheek reports that the UC-1147 CPU has the necessary large chunk of memory on board, so you're stuck with 200 channels. You can get the WSR from:

COMMtronics Engineering
PO Box 262478
San Diego, CA 92196

The Scanner Modification Handbook I and II are available from the same address. They're something like \$17.95 each + \$3 P&H. The WSR is \$25 per year.

NOTE : I am not responsible for anything that goes wrong. Note that this

Newsgroups: alt.radio.scanner
From: interpol@casbah.acns.nwu.edu (Interpol)
#Subject: Uniden Bearcat 200XLT Battery Indicator Modification
Message-ID: <1992Mar13.185815.15749@casbah.acns.nwu.edu>
Sender: interpol@nwu.edu
Organization: Northwestern University, Evanston, Illinois
Date: Fri, 13 Mar 1992 18:58:15 GMT
Lines: 161

Here's some mods to help remedy the 200XLT's low battery indicator/blank out feature, courtesy of Bob Parnass:

BC200XLT LOW BATTERY FIXES
Troy T. Pummill, N6XMV

Here are two small articles from MT. I have not tried these mods, do so at your own risk (i.e. your milage may vary).

From Monitoring Times
Bob's Tip of the Month
May 1990, page 98

BC200XLT SHORT BATTERY LIFE SOLVED

Short abttery life--sometime only an hour or two between charges--seems to be the only major complaint among owners of the laeading hand-held scanner, the Uniden Bearcat BC200XLT. Presumably, owners of similar sets like the BC100XLT BC205XLT, and Cobra 4030 could have the same problem. Now that is an ailment of the past.

It turns out that the batteries were not really at fault; a zener diode which determines the voltage at which the low-battery indicator would come on was defective in some units, causing the circuit to actuate prematurely. Replacing that idode and changing the value of an associated resistor provides the answer.

FREE FIX

MT contacted Uniden and was assured that they will provide the fix for free, even if the radio is outside of the one-year warranty period. If your Uniden BC200XLT suffers from short battery life, send the radioo along with a brief note describing the ailment, to Uniden Customer Service, 9900 West Point Drive, Indianapolis, Indiana, 46250.

As shown in the accompanying diagram, zener diode D203 and resistor R208 are the parts in question. D203 should be about 7 volts and R208 should be 150,000 ohms. These are miniature surface-mount devices on double-sided circuit board; if your radio is under warranty, attempting this fix yourself will void that warranty.

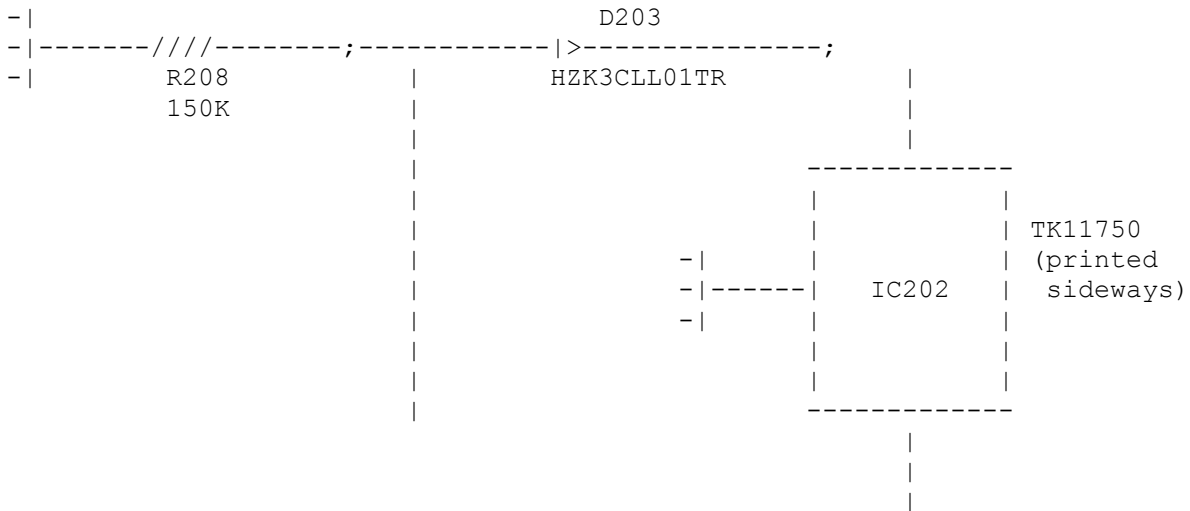

SHORT CUT

Mark Machcinski of Wyandotte, Michigan, came up with hisw own solution. He simply soldered a wire bridge across diode D203, disabling the low battery indicator entirely. The radio now operates uninterrupted until it blanks out when

the abttery level drops to about 4.5 volts.

Yet another suggestions from a Canadian reader would bridge the original diode with a 6.8K resistor, defeating the premature recharge signal, yet preventing the battery from too low a discharge.

From MT
June 1990, page 98
Bob's Tip of the Month

BC200XLT BATTERY LIFE EXTENSION: Part II

Every time we run a helpful hint on a popular product, some-one find an even more helpful hint! This one disable the low battery cutoff circuit and adds several hours of operation to a single charge. Our lab unit was still going strong after seven hours straight! Uniden will provide the fix for free, but if you're in a hurry and don't mind voiding your warranty, read on!

NOTE: This modification should not be attempted by anyone unfamilier with small circuit oard components.

The tools: You will need a small Phillips screwdriver, fine-tip soldering iron and solder wicking braid.

The procedure: Remove the battery pack, then the two screws form the bottom spring clip. Carefully pull the rear cover off, bottom first. Remove tjhe two small screws at the base of the circuit board. Pull the front panel away from the mainframe, bottom first.

At the bottom of the remaining board--to the left of the speaker magnet--are two blue electolytic capacitors; just above them are two striped components-- one resistor and one diode. Using the soldering iron and braid, carefully remove the two components without overheating the board or damaging the copper traces.

When you reassemble the radio, be very carful to note the insertion of the front panel into the slot at the base of the volume/squelch panel. Be especially careful to align the screw holes perfectly, allowing the two rows of fine pin contacts to mate correctly with the socket. If this is not done correctly (and it probably won't be the first time!) no damage will occur, but the scanner display will be blank.

Recharge your batteries after 6-8 hours of heavy use. If the scanner dies, recharge it as soon as possible to prevent loss of your memorized frequencies.



Voltage Regulator

[] [] []

[] resistor

[] diode

-- --
- - - -
-- --

capacitors (2, round)

- - -
- - -
- - -

Speaker Magnet

=====
Bob Parnass, AJ9S - AT&T Bell Laboratories - att!ihlpm!parnass - (708)979-5414

Drew S. Cheng, BA '91 MD '95	"Compelling, yet tedious...I
Northwestern University	feel spent, like a man who is
Medical School, Chicago, IL USA	forced to wear his genitals
IRC : "Interpol"	like a pendant."
| Internet : interpol@nwu.edu | - Dieter, "Sprockets" |
-----|
| Got any anime

stuff? |

Newsgroups: alt.radio.scanner
From: interpol@casbah.acns.nwu.edu (Interpol)
#Subject: Uniden Bearcat 200XLT Cellular Restoration Mod
Message-ID: <1992Mar13.190511.16655@casbah.acns.nwu.edu>
Sender: interpol@nwu.edu
Organization: Northwestern University, Evanston, Illinois
Date: Fri, 13 Mar 1992 19:05:11 GMT
Lines: 105

Yet another Uniden/Bearcat 200XLT modification, courtesy of Bob Parnass and other good people:

BC200/205XLT CELLULAR RESTORATION

Note: It is unlawful to monitor cellular telephone conversations. It is possible to monitor signals from the deleted ranges even without conversion. Simply add 21.7 MHz to the deleted frequency and enter the higher (image) frequency. Reception is virtually identical in strength to that which would be heard on the deleted frequency.

The frequencies deleted at the factory may be restored, but the procedure must not be attempted by anyone unfamiliar with electronic circuitry. Grove Enterprises assumes no liability for damage caused by this procedure. The modification will void your warranty.

TOOLS REQUIRED: Small Phillips screwdriver, small wire cutters.

1. Slide off the battery pack and remove the antenna from the scanner.
2. Using a small Phillips screwdriver, remove the two screws from the back of the scanner, the two screws which hold the battery retaining spring at the base and the spring itself.
3. Carefully pry the bottom of the rear cover from the radio and remove the cover.
4. Locate the two small screws at the base of the circuit board and remove them. Gently pull the front panel from the mainframe at the base and separate them.
5. Locate the (64 pin quad flatpack) microprocessor IC labelled "UNIDEN UC-1147" and the 10k ohm (brown-black-orange) leadless resistor positioned above the letters "DEN" on the IC.
6. Using miniature wire cutters, cut the resistor body in two without disturbing anything else near it. If the left solder pad comes loose, it may be peeled from the board. Brush or blow away any residue. This completes the restoration.

REASSEMBLY

7. Insert the top of the front panel into the slot under the volume/squelch control panel and, noting carefully the alignment of the dual inline connector at the bottom of the board with the mating socket, press the front panel firmly into place. Be sure that the holes at the bottom of the circuit board line up with the holes in the plastic standoffs below them. Insert the two screws and gently tighten them.
8. Replace the back cover by inserting the top of the cover into the slot under the volume/squelch control panel; press the cover into place, insert and tighten the screws.
9. Reposition the battery retaining spring (slotted side toward notched hole), insert the two remaining screws and gently but securely tighten them.
10. Slide the battery pack into place; switch the scanner on to make sure the display comes on. If not, the battery is discharged or the dual-inline connector was misaligned during assembly (see step 7).

Assuming the display comes on, press: MANUAL, 845.0, E; within two seconds,

the
frequency 845.000 should appear on the display.

Cut this resistor
|
V
[*10k*] []

```

I I I I I I I I I I I I I I I I I I
=
=
=
=          U N I D E N
=
=
=
=          U C - 1 1 4 7
=
=
=
I I I I I I I I I I I I I I I I I I

```

Pete Simpson, KA1AXY
Data General Corp
Westboro, MA 01580
(508) 870-9837

SIMPSON_P@MERCURY.CEO.DG.COM

"My company doesn't have anything to
do with this."

that's it.....et.

Edward Thomas, N2IHN.
P.O.Box 3233
Long Branch,NJ. 07740 UUCP: rutgers!petsd!tsdiag!ka2qhd!n2ihn

Drew S. Cheng, BA '91 MD '95	"Compelling, yet tedious...I	
Northwestern University	feel spent, like a man who is	
Medical School, Chicago, IL USA	forced to wear his genitals	
IRC : "Interpol"	like a pendant."	
Internet : interpol@nwu.edu	- Dieter, "Sprockets"	

stuff? | | Got any anime

Newsgroups: alt.radio.scanner
From: interpol@casbah.acns.nwu.edu (Interpol)
#Subject: Uniden Bearcat 200XLT 136-174 AM Modification
Message-ID: <1992Mar13.193440.20576@casbah.acns.nwu.edu>
Sender: interpol@nwu.edu
Organization: Northwestern University, Evanston, Illinois
Date: Fri, 13 Mar 1992 19:34:40 GMT
Lines: 39

Here's the last of the 200XLT mods I know of...downloaded off of a local BBS here in Chicago:

Modification for Putting BC-220XLT In AM Reception Mode

I have come up with a crude mod for the BC200xlt scanner to allow AM reception in the 136 to 174 range. Why would I want AM in this range you ask? well I attend several Air shows during the year and the Thunderbirds use 140 mhz area freqs. As we all know the Uniden switches to FM in this range, causing very distorted reception (slope detection). Somebody else may have already thought of this idea (you?) but here goes. Break the AIR Trace between dual diode D31 and IC1 pin 8. Connect the center of a single pole - double throw mini switch to the trace leading back to IC1 pin 8. Connect one of the other poles to the trace leading back to D31. This is the "Normal" mode(This just restores what you have cut). Now connect the other pole to the VHI (VHF HI) line at a easy to locate point. This is the "AM" mode. What will happen now is when AM is selected the VHF and VHF air band will all be in the AM mode. UHF and others are not affected. When in the normal mode everything is just like it always was. I have done this mode over a year ago so it's still a cloudy in my memory. But it works like this: The microprocessor sends a high to Q7 to select the AIR mode, by routing the VHI signal around D31 by means of the switch the AM detector is reselected. Normaly D31 blocks out the VHI signal allowing FM in the VHF HI range. I hope my explanation of this mod is clear. It does take some delicate surgery to do. I also hope I haven't duplicated anyone elses idea.

Thanks

From: BILLY WIGGINS

```
-----  
| Drew S. Cheng, BA '91 MD '95           | "Compelling, yet tedious...I      |  
| Northwestern University                | feel spent, like a man who is    |  
| Medical School, Chicago, IL USA       | forced to wear his genitals     |  
| IRC : "Interpol"                      | like a pendant."                |  
| Internet : interpol@nwu.edu           | - Dieter, "Sprockets"           |  
-----  
| Got any anime  
stuff? |  
-----
```

Newsgroups: alt.radio.scanner
 From: brett@surfpix.princeton.edu (Brett Borowski)
 Subject: BC200xlt CPU pinouts!
 Message-ID: <1992Dec17.222525.11836@Princeton.EDU>
 Originator: news@nimaster
 Sender: news@Princeton.EDU (USENET News System)
 Nntp-Posting-Host: surfpix.princeton.edu
 Organization: Princeton University
 Date: Thu, 17 Dec 1992 22:25:25 GMT
 Lines: 63

Pinouts for the UC1147 CPU in the Uniden BC200xlt scanner....

Note: ! means "not," If a pin does not have a designation, its destination is given. Ex. "Gnd" means the pin is designated "Gnd" but "to Gnd" means the pins was unlabeled but connected to ground. This info comes from my reading the schematic from the service manual--sorry for any errors!

Pin		Pin	
1	CL1 (Keypad)	33	!CS1
2	CL3 (Keypad)	34	!CS2
3	CL4 (Keypad)	35	to Gnd
4	CL5 (Keypad)	36	to Gnd
5	CL6 (Keypad)	37	to Gnd
6	to VCC	38	to Gnd
7	to VCC	39	to Gnd
8	RW1 (Keypad)	40	to Gnd
9	RW2 (Keypad)	41	!SKIP (to
Gnd via R(10k)			
10	RW3 (Keypad)	42	to Gnd
11	RW4 (Keypad)	43	RESET
12	to VCC	44	!TEST
13	to Gnd	45	OSC1
14	to Gnd	46	OSC2
15	to Gnd via R(unknown)	47	GND
16	!HLT	48	!BL
17	to Gnd	49	SC
18	to Gnd via R(unknown)	50	!800
19	to Gnd via R(unknown)	51	!UHF (assumed)
20	to Gnd	52	AIR
21	!BUSY	53	VHI
22	!RST	54	VLO
23	!C/D	55	n/c
24	!CS	56	SHIFT
25	VLC3	57	n/c
26	VCC	58	MUTE
27	!SCK	59	!P/OFF
28	SI	60	to VCC
29	SC	61	to VCC
30	PLLEN	62	to VCC
31	!EN1	63	LIGHT
32	!EN2	64	CL2
(assumed) (keypad)			

R(unknown) values were not listed on the schematic or in the parts list.
 (assumed) labels are based on the implications of other labels on the

schematic.

15, 18, and 19 look like they could be interesting....
And 41 should be interesting to people who don't want their scanner to
"skip" certain frequency ranges....

OSC1 and OSC2 are the feed in for the 400mhz oscillator. This oscillator
can be replaced with a faster one to increase the scan/search speed...but
it will also decrease your light on-time... And as far as keeping the
light on all the time...one could connect a switch to the LIGHT pin and
a VCC. When off, it would function as normal. When on, the light would
go on and off with the power. Watch out for short circuits if you do
this...I fried a transistor on mine when I had a VCC to Gnd short....

Happy hacking!

Brett

--

brett@surfpix.princeton.edu

Date: Fri, 26 May 89 08:51:34 edt
From: <PZS@MERCURY.MCEO.DG.COM>
Subject: Mods for BC200/205XLT

CEO file contents:

The following was received from Grove Enterprises with my friend's
BC200XLT.

.....
.

BC200/205XLT CELLULAR RESTORATION

Note: It is unlawful to monitor cellular telephone conversations. It is possible to monitor signals from the deleted ranges even without conversion. Simply add 21.7 MHz to the deleted frequency and enter the higher (image) frequency. Reception is virtually identical in strength to that which would be heard on the deleted frequency.

The frequencies deleted at the factory may be restored, but the procedure must not be attempted by anyone unfamiliar with electronic circuitry. Grove Enterprises assumes no liability for damage caused by this procedure. The modification will void your warranty.

TOOLS REQUIRED: Small Phillips screwdriver, small wire cutters.

1. Slide off the battery pack and remove the antenna from the scanner.
2. Using a small Phillips screwdriver, remove the two screws from the back of the scanner, the two screws which hold the battery retaining spring at the base and the spring itself.
3. Carefully pry the bottom of the rear cover from the radio and remove the cover.
4. Locate the two small screws at the base of the circuit board and remove them. Gently pull the front panel from the mainframe at the base and separate them.
5. Locate the (64 pin quad flatpack) microprocessor IC labelled "UNIDEN UC-1147" and the 10k ohm (brown-black-orange) leadless resistor positioned above the letters "DEN" on the IC.
6. Using miniature wire cutters, cut the resistor body in two without disturbing anything else near it. If the left solder pad comes loose, it may be peeled from the board. Brush or blow away any residue. This completes the restoration.

REASSEMBLY

7. Insert the top of the front panel into the slot under the volume/squelch control panel and, noting carefully the alignment of the dual inline connector at the bottom of the board with the mating socket, press the front panel firmly into place. Be sure that the holes at the bottom of the circuit board line up with the holes in the plastic standoffs below them. Insert the two screws and gently tighten them.

8. Replace the back cover by inserting the top of the cover into the slot under the volume/squelch control panel; press the cover into place, insert and tighten the screws.

9. Reposition the battery retaining spring (slotted side toward notched hole), insert the two remaining screws and gently but securely tighten them.

10. Slide the battery pack into place; switch the scanner on to make sure the display comes on. If not, the battery is discharged or the dual-inline connector was misaligned during assembly (see step 7).

Assuming the display comes on, press: MANUAL, 845.0, E; within two seconds, the frequency 845.000 should appear on the display.

Cut this resistor
 |
 V
 [*10k*] []

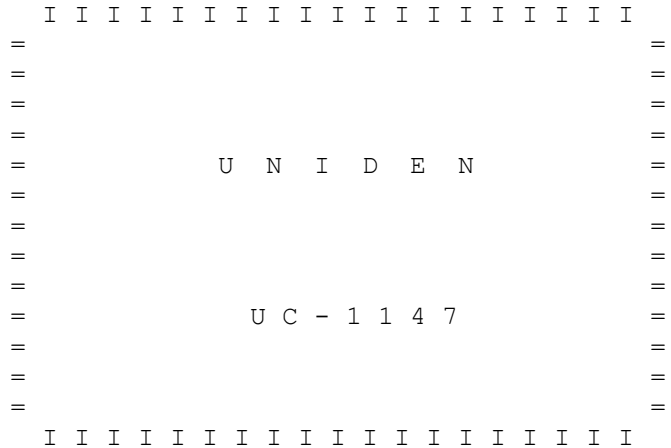

Article 23809 of rec.radio.amateur.misc:
Newsgroups: rec.radio.amateur.misc
Path: west.West.Sun.COM!sun-barr!sh.wide!wnoc-tyo-news!nec-tyo!nec-gw!mips!
sdd.hp.com!cs.utexas.edu!uunet!mcsun!news.funet.fi!ajk.tele.fi!funic!nokia.fi!
ds04.dco.ntc.nokia.com!marttanen
From: marttanen@ds04.dco.ntc.nokia.com (Kari 'Kama' Marttanen)
Subject: Extra functions for Standard C528/520
Message-ID: <1992Aug21.234542.1@ds04.dco.ntc.nokia.com>
Lines: 86
Sender: usenet@noknic.nokia.fi (USENET at noknic)
Nntp-Posting-Host: ds04.dco.ntc.nokia.com
Organization: Nokia Data Communications
Date: Fri, 21 Aug 1992 21:45:42 GMT

EXTRA FUNCTIONS FOR THE STANDARD C520/528

1). ADDITIONAL FUNCTIONS WHILST IN "SET MODE"

While holding the [FUNC] button press the [0/SET SB] button to enter set mode. (See Section 15 in manual).
Whilst still in set mode the following buttons can be pressed, together with the [FUNC] button, to provide the these functions

BUTTON -----	FUNCTION -----
[3/PO]	Changes band in use in extended coverage mode (UHF Only) i.e. 300 MHz / 400 MHz / 800 MHz / 900 MHz
[4/FL DM]	Displays a "." between 2nd & 3rd Digit. What else it does is a mystery, if anyone knows please let me know.
[6/STEP]	Toggles the tuning steps on the knob on top whilst [FUNC] is depressed, between 1MHz and 0.1 MHz.
[8/RPT]	Enables / Disables Cross band talk through mode. When Enabled a "." appears to the top right of the memory number position.
[9/REV]	Toggles UP and DOWN buttons between the normal steps and 10 MHz steps.
[DWN/* PS]	Enter cloning mode. Transfers all memory data between 2 x C520/528's. Tune both radios to the same frequency on one of the bands. Enter cloning mode on both radios. Press PTT on the radio that contains the memory data, A series of DTMF tone will be heard for approx 2 minutes. The receiving radio's memories will now be identical to the transmitting radio.

2). EXTRA MEMORY FUNCTIONS, 40 MEMORY CHANNELS or SEPARATE TX/RX FREQ`S

Although the standard manual states that 20 memories are available split between VHF and UHF bands, in fact there are 2 memory channels for each memory number on the VHF and UHF bands. These can be used in 2 ways. One way is to double the number of simplex channels available,

another is to provide programable RX and TX frequencies for each memory number.

a) PROGRAMMING SEPARATE RX & TX FREQUENCIES IN ONE MEMORY LOCATION

1. In VFO mode select your RX frequency
2. Press [FUNC] and [V/M ENT] buttons together
3. Press the memory number to be programmed
4. Press [V/M ENT] button to return to VFO mode
5. Select your TX frequency.
6. Press [V/M ENT] and [FUNC] buttons together
7. Press [FUNC] button together with the memory number to program

"+-" Will appear in the repeater shift display to indicate that the memory channel is now in split frequency mode. Once a memory location has been put into split frequency mode it cannot be changed back to a simplex memory unless it is programmed as an extra channel (see below) or a RESET is carried out.

Pressing [FUNC] and [9/REV] will cause the RX and TX frequencies to be swapped.

b) PROGRAMMING EXTRA MEMORY CHANNELS, EXTENDS TO 40 MEMORIES.

Program the first 10 memories on each band as per the manual. To program the additional 10 memories on each band follow the instructions below.

1. In VFO mode select the frequency required.
2. Press [FUNC] and [V/M ENT] buttons together.
3. Press [FUNC] and [A/CL] Buttons together. (an \bar{M} will be displayed)
4. Press the memory number to be programmed

To recall these extra memories. Either use the rotary tuning control in memory mode, which will now cycle through all programmed memories. Or enter memory mode and press [FUNC] and [A/CL] together and the bar will appear above "M" indicator as when it was programmed, pressing buttons 0 to 9 will then recall the extended channels.

The extended memory channels can have repeater shifts and CTCSS tones programmed in to them in the normal way BUT the value of the repeater offset and the frequency of the CTCSS tone will be the same for both of the channels stored in one memory location. i.e memory 1 and -1 will both have the same repeater offset but if the offset is not activated on channel -1 then it can be used as a simplex channel.

All the functions for the standard C528 are as below. If anyone out there has any that aren't listed, please mail to me!

Standard C520/C528 Modifications

~~~~~  
This file is a compendium from to others being bandied about the place. It is hoped this will be the better of them, being the easiest to follow!

o To open up the rx only up on the unit on VHF:



VHF F+0 F+D

- o To add 320-400MHz, 400-480MHz, 820-900MHz, 900-980MHz:  
UHF F+L F+0 F+B F+L F+3 A
- o To Expand Tx/Rx coverage, do both the above in that order, then:  
VHF F+6 change step to 12.5MHz A  
F+8 F+8 F+C  
Tune down to 144.9875  
F+0 F+D PTT F+8 F+C
- o To Store independent transmit/receive frequency in one channel:  
Enter receive frequency into dial  
F+D <mem number>  
Enter transmit frequency into dial  
F+D F+A F+<mem number> A
- o To Clear the tx assignment offset:  
F+D F+A <mem number>+A F+A A
- o To Clone one set to another:  
B B F+0 F+PS then key up on the set to clone from

Set mode key assignments:

The set mode allows a number of user parameters to be customised according to individual taste. Set mode is initiated by pressing F+0. The following are entered after going into set mode:

- 0 Turns off the beep tones on each keypress  
F+0 Sets band edge limits, i.e. 0079=100-179, 400-479. 3060=130-160
- 1 Changes count of paging operations tone, one beep or 5  
F+1 Set tx delay on carrier drop when using as cross-band repeater
- 2 Enables entry of the 1kHz figure on direct keypad entry  
F+2 Stop scan on busy channel even if CTCSS doesn't match
- 3 Sets mod delay on paging Tx to either 450ms or 750ms  
F+3 Switch UHF bands between 300/400/800/900
- 4 Mutes short noises during squelch operation  
F+4 Keypad entry of 4 digit or 3 digit frequency
- 5 Turns on and off the auto power off function  
F+5 Pager Audio Mute (Mutes any audio that follows the paging signal)
- 6 Enable/Disable the rotary channel knob when keypad locked  
F+6 Fast tune (F+KNOB) gives either 1MHz steps, or 100kHz
- 7 Sets the CTCSS tone frequency  
F+7 Either Dual Tone Multi Frequency, or Single Tone Frequency
- 8 Sets the offset repeater frequency  
F+8 Cross Band Repeater Enable/Disable (Identified on display by a ".")
- 9 Changes the LAMP button into the REV button  
F+9 Up and Down keys either act as the knob, or as 10MHz steps.

```

-----/
|                                     Standard C520/528 - Keypad Guide                                     |
|-----|-----|-----|-----|
|Key| Alone | With "FUNC" key | Key alone in set |In Set With "F" | | |
|---|---|---|---|---|---|---|
| 0 | 0 | |Enter Set Mode |Mute keypad bleep |Set Band Edge Limit|
| 1 | 1 | |PTT Lock |1/5 beeps when paged|Tx wait on c-b rept|
| 2 | 2 | |Dual Watch |1kHz entry on keypad|Match CTCSS on scan|
| 3 | 3 | |Output Power |Tx Delay on repeater|Switch UHF Bands |
| 4 | 4 | |Frequency Lock |Mute noises dur sql |Dir Input 4/3 figrs|
| 5 | 5 | |Battery Saver |Automatic power off |No audio after page|
| 6 | 6 | |Select Step Size |Enable tune in lock |Fast tune 1MHz/100k|
| 7 | 7 | |CTCSS select TX/RX |CTCSS tone frequency|Single/Dual tone MF|
| 8 | 8 | |Repeater Shift +/- |Set Tx/Rx split freq|Cross Band Repeater|
| 9 | 9 | |Reverse Repeat Shift|Make LAMP button REV|Up/Dn keys do 10MHz|
| * | | |Step Down|Search 1MHz band | | |
| # | | |Step Up |Memory Shift | | |
| A | | |Cancel | | | |
| B | | |Pager On |Set Pager Codes | | |
| C | | |Mem Scan |Partial Memory Scan | | |
| D | | |Dial/Mem |Store Dial In Memory| |Extend RX coverage|
|-----|-----|-----|-----|
| Expand:VHF F+0 F+D A | Independent Transmit/Receive Frequency |
| UHF F+L F+0 F+B F+L F+3 A | [Rx] F+D <mem> [Tx] F+D F+A F+<mem> A |
| VHF F+6 step to 12.5MHz A | Remove Independent Tx Freq From Memory |
| F+8 F+8 F+C | F+D F+A <mem>+A F+A A |
| tune down to 144.9875 | Clone One Set To Another |
| F+0 F+D PTT F+8 F+C | B B F+0 F+* [PTT] on source set |
|-----|-----|-----|-----|
Origin 2:252/140 @ fido :: 17/09/91 :: sysop@f140.n252.z2.fidonet.org

```



From: <U27387@uicvm.uic.edu>  
Date: Wednesday, 28 Oct 1992 10:13:09 CST  
Newsgroups: rec.radio.amateur.misc  
Organization: University of Illinois at Chicago  
Message-ID: <92302.101309U27387@uicvm.uic.edu>  
Subject: Standard HT 528 mods (999MHz)  
Lines: 27

This simple key-in sequence will enable the Standard 528 twin band HT to receive out of band signals up 999MHz.

- 1) enter UHF side (UHF is main)
- 2) enter VFO mode
- 3) push F + L (function key + light key)
- 4) then F + 0 (function key + zero key)
- 5) next F + code (function key + code key)
- 6) then F + L (function key + light key (again))
- 7) next F + 3 (function key + three key)
- 8) then PTT (push to talk button)

Now your in! To change bands you have to press F + 0 followed by F + 3 , this is the toggle function. Each time you enter the F + 0 and F + 3 the receiver will jump bands. To get back to 440 (where you started from) keep using the toggle sequence.

If you did something wrong and the HT losses its mind DON'T PANIC! Just push the microproc. reset button. I have done this keyboard entry mod to my HT and it works. The sensitivity isn't great, but you can pick up anything that has a strong signal.

This information was obtained from the local Standard representative in Chicago. I'm sure there are other things This radio can do that I am not aware of, but when I find out I will post it here just for the heck of it. P.S. If I made a mistake in the key sequence list above I will post any corrections by the end of this week 10/30/92.  
good luck!

Chris...

Newsgroups: rec.radio.amateur.misc  
From: Lawrie.Brown@adfa.oz.au  
#Subject: Re: Standard HT 528 receive mods (999MHz)  
Message-ID: <1992Nov3.061703.18332@sserve.cc.adfa.oz.au>  
Sender: news@sserve.cc.adfa.oz.au  
Organization: Australian Defence Force Academy, Canberra, Australia  
References: <92302.101309U27387@uicvm.uic.edu>  
Date: Tue, 3 Nov 1992 06:17:03 GMT  
Lines: 55

<U27387@uicvm.uic.edu> writes:

>This simple key-in sequence will enable the Standard 528 twin band HT  
>to receive out of band signals up 999MHz.

I too have a Standard C528 (as do quite a few of the other local amateurs here), and I'm very happy with it. In addition to the sequence you gave, there is also a (longer) sequence which enables wide-band transmit (how wide I don't know as I've no need to use it). There are also quite a few additional functions available off the keyboard from those documented.

Appended below this is a table (which I keep as an Excel spreadsheet), listing the various functions in rather abbreviated form - I'd be very interested in learning about any others.

Note the extra memory channels - there are actually 20 on each band, the upper 10 are accessed as shown below (accessed with a F+A prefix key, and displayed with a bar over the number). You can't use them in band scanning, but apart from that they function as normal memories.

Cheers  
Lawrie Brown VK1KLB

| Standard C528 Keystroke Cheat-sheet |         |             |                    |                     |                  |
|-------------------------------------|---------|-------------|--------------------|---------------------|------------------|
| Key                                 | key     | F+key       | Set, key           | Set, F+key          |                  |
| 0                                   | 0       |             | Set / Scan mode    | Mute beep           | Set freq limits  |
| 1                                   | 1       |             | PTT Lock           | # Pager beeps       | 2sec xBRPT delay |
| 2                                   | 2       |             | Dual Operation     | 1 kHz entry         | Tone scan stop   |
| 3                                   | 3       |             | TX Power           | Pager TX delay      | UHF band switch  |
| 4                                   | 4       |             | Freq lock          | Squelch mute        | 4 digit entry    |
| 5                                   | 5       |             | Battery save       | Auto Power save     | Mute pager audio |
| 6                                   | 6       |             | Tuning step        | Rotary enable in FL | 1MHz step        |
| 7                                   | 7       |             | Tone coder on/off  | Set Tone freq       | DTMF single tone |
| 8                                   | 8       |             | Repeater mode      | Set Offset freq     | Crossband RPT    |
| 9                                   | 9       |             | Reverse mode       | LAMP is REV         | 10MHz up/down    |
| *                                   | PS      | step DOWN   | Dial/Tone Scan     |                     | DTMF Clone       |
| #                                   | SIFT    | step UP     | Memory freq shift  |                     |                  |
| Call                                |         | Tone burst  |                    |                     |                  |
| A                                   | CL      | Cancel      |                    |                     |                  |
| B                                   | PAG     | Page on/off | Page code set/show |                     |                  |
| C                                   | MS MS.M | Mem scan    | MS.M set/scan      |                     |                  |
| D                                   | V/M ENT | Mem<->      | Dial Memory set    |                     |                  |
| VHF                                 |         | VHF main    | VHF only           |                     |                  |
| UHF                                 |         | UHF main    | UHF only           |                     |                  |
| LAMP                                |         | Lamp on/off | Lamp toggle        |                     |                  |
| SQL OFF                             |         | Squelch off | sub-band sql off   |                     |                  |

#### Other Key Sequences

Wideband RX: Reset, VHF, F+0, F+D, PTT, UHF, F+L, F+0, F+B, F+L, F+3, PTT  
Wideband TX: VHF, F+6, PTT, F+8, F+8, F+7, F+7, F+C, rotate down 1,  
" F+0, F+D, PTT, F+8, F+C, F+0, F+4 (F+0, F+3)\*4  
Set Upper 10 Memory channels: F+D, F+A, num

Newsgroups: rec.radio.amateur.misc  
From: wa2ise@cbnewsb.cb.att.com (robert.f.casey)  
#Subject: C528 extended RX/TX and other keyboard mods file  
Message-ID: <1992Dec14.151833.9694@cbfsb.cb.att.com>  
Keywords: mods  
Sender: news@cbfsb.cb.att.com  
Organization: AT&T  
Date: Mon, 14 Dec 1992 15:18:33 GMT  
Lines: 186

received this on packet:

Msg# TSF Size #Rd Date Time From MsgID To  
30546 PY 4803 1 03-Dec 1626 G7IED 27645\_GB7LAN WA2ISE ()  
Sb: C528

Here is a little mods list. I find the 40ch mem a bit messy so  
I don't use it and you can get the phone tones by pressing  
the ptt and a number on the pad.

Hope this is of help to you

73s

Ralph

V7

The 520/28 is very flexible capable  
of TX RX on 122.825 to 176.800MHz  
and 328.000 to 473.125MHz.  
And RX only on 820.225 to 972.500MHz.  
The following are not in the owners book.  
F=FUNC L=LIGHT

---

There are two ways to set Rx wide band  
if you press reset you will need this  
(A)

- 1 F + VHF
- 2 F + 0
- 3 F + D
- 4 RELEASE F
- 5 PRESS UHF
- 6 F + 0
- 7 F + D
- 8 F + L
- 9 F + B
- 10 F + 3
- 11 F + 0
- 12 F + 3
- 13 F + 0
- 14 F + 3
- 15 F + L

TO CANCEL RESET?

---

(B)

- 1 F + 0
- 2 F + D
- 3 PTT ON 145.00MHz IS DISPLAYED
- 4 PRESS VHF
- 5 F + L
- 6 F + 0
- 7 F + B
- 8 F + L
- 9 F + 3
- 10 PTT ON 433.00MHz IS DISPLAYED

TO CANCEL RESET?  
THE RX IS NOW WIDE BAND  
FOR TX CONTINUE BELOW

---

TX WIDE BAND PROCEDURE

1 VHF  
2 F + 6  
3 CHANGE FREQUENCY STEP FROM 10KHz  
TO 12.5KHz BY ROTARY SELECTOR  
4 PTT ON 145.00MHz IS DISPLAYED  
5 F + 8  
6 F + 8 CONFIRM T AND + IN DISPLAY  
7 F + 7  
8 F + 7  
9 F + C  
10 SET 144.9875 BY ROTARY SELECTOR  
11 CONFIRM THE SMALL 75 ON DISPLAY  
12 F + 0  
13 F + D  
14 PTT ON  
15 F + 8  
16 F + C  
TO CANCEL RESET?

---

TO TOGGLE BETWEEN 3-400 AND 8-960 MHz

1 SET MAIN BAND TO UHF  
2 F + 0  
3 F + 3

---

DIRECT 4 DIGIT KEY INPUT

1 F + 0  
2 F + 4  
DISPLAYS A . BETWEEN 2nd AND 3rd DIGIT  
TO CANCEL REPEAT ABOVE

---

10 MHz SHIFT BY UP/DOWN KEYS

1 F + 0  
2 F + 9  
TO CANCEL REPEAT ABOVE

---

40 CHANNELS MEMORY

THERE ARE 2 MEMORY CHANNELS PER MEMORY  
NO ON VHF AND UHF. THEY CAN BE USED IN 2 WAYS.

(A) TO PROVIDE PROGRAMBLE RX TX FREQUENCIES  
(B) TO DOUBLE THE SIMPLEX CHANNELS AVAILIDLE

(A)

1 SELECT RX FREQ (VFO MODE)  
2 F + D  
3 PRESS MEMORY NO TO BE PROGRAMMED  
4 D  
5 SELECT TX FREQUENCY  
6 F + D  
7 F + THE MEMORY NO TO BE PROGRAMMED  
+ - WILL APPEAR INDICATES THAT MEMORY  
CHANNEL IS IN SPLIT FREQUENCY MODE  
ONCE A MEMORY IS IN SPLIT MODE IT  
CANNOT BE CHANGED BACK TO A SINGLE  
MEMORY UNLESS ITS PROGRAMMED AS A  
EXTRA CHANNEL (SEE BELOW) OR RESET  
F + 9 WILL SWAPP RX AND TX

(B)

EXTEND TO 40 MEMORIES

PROGRAM FIRST 10 MEMORIES IN EACH BAND  
TO PROGRAM ADDITIONAL 10 MEMORIES

1 SELECT FREQUENCY (VFO MODE)  
2 F + D  
3 F + A AN  $\bar{M}$  WILL APPEAR  
4 PRESS MEMORY NO TO BE PROGRAMMED  
TO RECALL EXTRA MEMORIES USE ROTARY  
CONTROL IN MEMORY MODE OR ENTER MEMORY  
MODE AND PRESS

F + A  
THE M AND BAR APPEARS PRESSING  
0 TO 9 WILL RECALL EX CHANNELS  
THE EX CHANNELS CAN HAVE REP SHIFT  
AND CTCSS TONES BUT VALUE WILL BE THE  
SAME FOR BOTH CHANNELS IN ONE MEMORY

---

DTMF CLONE

COPYS YOUR SETTINGS TO ANOTHER 520/28  
TUNE BOTH RADIOS TO SAME FREQUENCY

1 B P IS DISPLAYED  
2 B C IS DISPLAYED  
3 F + 0  
4 F + PS  
5 PTT ONLY ON THE RADIO THAT CONTAINS  
THE MEMORY DATA

A SERIES OF TONES WILL BE HEARD FOR  
APPROX 2 MINUTES THE RADIO MEMORYS  
WILL NOW BE IDENTICAL

---

DTMF SINGLE TONE

1 F + 0  
2 F + 7  
TO CANCEL REPEAT ABOVE

---

MUTING THE AUDIO OUTPUT OF PAGER

1 F + 0  
2 F + 5  
TO CANCEL REPEAT ABOVE

---

STONE SQUELCH SCAN STOP

1 F + 0  
2 F + 2  
TO CANCEL REPEAT ABOVE

---

H.H.TRANSPONDER SUB BAND TO MAIN

1 F + 0  
2 F + 8  
A . APPEARS TOP RIGHT OF MEMORY NO  
TO CANCEL SET SUB BAND ON CLEAR FREQUENCY  
BY ROTARY SELECTOR AND PRESS UHF OR VHF

---

TOGGELS BETWEEN 100KHz AND 1MHz STEPS

ON ROTARY SELECTOR WHEN FUNC IS PRESSED (FAST TUNING RATE)  
1 F + 0  
2 F + 6

---

SET FREQUENCY LIMIT ON EACH BAND



1 F + 0  
2 F + 0

---

SET TX HANG DURING TRANAPONDER FUNC

1 F + 0  
2 F + 1

---

Be very carfull with the h.h.transponder  
and wide band tx func.

73s Ralph  
G7IED @ GB7FCI

---

Note: I haven't tried or verified this, proceed at your own risk. And  
do not transmit outside of legal bands! WA2ISE









Subject: Radio Modification Database

2010.mod ICF-2010 adjustment revisited  
2010freq.mod Sony 2010 SSB Adjustment  
56kbfix.mod 56K modem fixes  
760xlt.mod Bearcat Mods  
allband.mod ICOM IC-2AT, IC-02AT Mods  
alr22t.mod Extended frequency rx and tx of the ALR22T & ALR22HT  
aur1500.mod Review: AOR AR-1500 handheld scanner  
ar1000.mod Reprogramming the AR1000  
bbc txt.mod Radio reviews  
bc200.mod Uniden Bearcat 200XLT Modifications  
bc200xlt.mod BC200xlt CPU pinouts!  
bc205xlt.mod Mods for BC200/205XLT  
c520.mod Extra functions for Standard C528/520  
c528.mod Standard HT 528 mods (999MHz)  
c558.mod THE REAL Standard 558 radio mod  
dj120.mod Alinco DJ120 extended transmit mod file  
dj160.mod DJ-160 MODS  
dj162.mod Alinco DJ-162 Mod - (Here's How)  
dj500.mod DJ500 Mod  
dj560.mod UPDATE: MOD for 800MHz RX on DJ-560!  
dj580.mod Mod for ALINCO DJ-580T D/B HH  
dj\_580.mod DJ580 Mod  
djf1.mod ALINCO F1 2 METER HANDHELD  
djf1t.mod Alinco DJF1T mods  
dr110.mod DR110 mod file  
dr110p.mod 9600 baud mod for Alinco 110, 112, 1200 radios  
dr1200.mod MFJ - ALINCO & 9600  
dr1200\_1.mod DR1200 InterMOD reduction mod file  
dr1200t.mod Alinco DR1200t full band mod file  
dr130.mod DR130 MARS mod file  
dr510.mod Alinco DR510 Crossband Repeater Mod  
dr570.mod DR570 MODS  
dr599t.mod DR599t extended RX mod file  
dr600.mod DR600 Mod  
dx440.mod DX440 mod  
dx440txt.mod Re: DX440 mod  
dx\_440.mod Sangean ATS803A/Realistic DX-440 Radio Modification  
ft1000.mod FT990 and 1000 extended xmit mod file  
ft101e.mod FT101E mods so you can use USA final tubes  
ft209rh.mod FT-209RH mods resolved  
ft212rh.mod FT212 mods  
ft233373.mod FT23, 33, 73 extended range mods  
ft23\_211.mod FT23 FT73 & FT211 mod files  
ft23r.mod YAESU FT-23R EXTENDED FREQUENCY RANGE:  
ft2400.mod Yaesu FT2400H frequency mod  
ft2400\_1.mod FT2400 mod file  
ft411\_1.mod Yaesu FT-411E Mods  
ft411\_2.mod PTT MOD FOR FT-411  
ft415815.mod FT415 & 815 mod files  
ft4700.mod FT 4700 Mod  
ft470\_1.mod Re: Yeasu FT-470 mods?  
ft470\_2.mod FT470 extended VHF xmit mod file  
ft470\_3.mod FT470 mods  
ft5100.mod Re: Yaesu FT-5100 Help  
ft5100\_1.mod Additional feature on Yaesu FT-5100 found: adjustable  
timeout

ft5100 2.mod Yaesu FT-5100/5200 mods  
ft5100if.mod Yaesu FT-5100 CAT/Remote Control Mike Interface  
ft5200.mod FT5200 crossband mod file  
ft5200a.mod FT 5200A Mod  
ft530.mod Re: FT530 mods wanted!  
ft650.mod FT650 noise blanker mod file  
ft726r.mod Re: Mods for ft726r to do 9600  
ft727.mod FT727R MODS  
ft727cat.mod ft727r CAT interface  
ft727r.mod YAESU FT-727R  
ft736r.mod FT736 2m RX mod!  
ft747.mod FT747 mod file  
ft747gx.mod General coverage mod for YAESU FT-747GX  
ft757.mod FT757 mod file GX and GXII  
ft757gx.mod Re: How to broadband a Yaesu FT-757GXII?  
ft767gx.mod YAESU FT767GX mod  
ft890.mod ft890 mod file  
ft990.mod FT990 mod file  
ft990 1.mod YAESU FT-990  
ft990 2.mod FT990 and 1000 extended xmit mod file  
ft990 3.mod Re: FT990 mod for extended tx  
fx146.mod Ramsey FX 146 mod for packet file  
ge\_mvp.mod G.E. MVP to a Repeater (Instructions)  
hb232txt.mod HB-232 Announcement  
hf250txt.mod HF-250 Update  
hr2600.mod UNIDEN QSK MODIFICATION  
htx100.mod R/S HTX-100 Modifications  
htx101.mod Radio Shark HTX101 mod file  
hw 24.mod HW-24 extended RX mod file  
ic02.mod BAND EXPANSION MODIFICATION FOR IC-02AT  
ic02 2.mod Another Icom IC02 Modification  
ic02 3.mod AUDIO MODIFICATION FOR ICOM IC02 AND IC04 RADIOS =====  
ic02a.mod IC-02A mod  
ic04.mod OUT OF BAND MODIFICATION FOR ICOM IC-04  
ic2410.mod ICOM IC-2410 mods  
ic24 2.mod IC24AT New Info  
ic24 3.mod Mod for IC-24AT  
ic28.mod ICOM IC-28A AND IC-28H  
ic2at.mod mars/cap mod file for the IC2AT  
ic2gat.mod ICOM 2GAT Mods  
ic2sat.mod IC-2SAT TX/RX mod  
ic2sat 2.mod Icom IC-2SAT enhancements, part 2  
ic2sra.mod Icom IC-2SRA Mods  
ic32.mod IC-32 Mod  
ic3200a.mod Local packet QS0s / dual band rigs?  
ic32 2.mod IC-32AT Modifications  
ic37.mod some IC37 mods  
ic4sat.mod Icom IC-4SAT xtnded transmit mod - how to  
ic7100.mod ICOM ICR7100 RECEIVER (365 lines)  
ic725.mod Need Help on Mod for Icom 725  
ic735ibm.mod ICOM 735 <-> IBM Notes  
ic751.mod IC-751 split mode mod  
ic900.mod Icom IC-900 mods  
ic901a.mod IC-901A Frequency Ranges  
ic 24.mod IC-24AT Receive Mods  
ic mu2.mod BAND EXPANSION MODIFICATION FOR ICOM MICRO2 =====  
ic p2at.mod ICOM P2AT keyboard mods

icom32at.mod ICOM 32AT MODS  
icom735.mod Xmit Mods for IC-735  
icom mem.mod R-71A Memory Notes  
icom ram.mod ICxx71 ram adaptor for use with eprom programmer  
icw2a.mod Icom W2A Mods  
icw2a 1.mod Re: W2A receiver modification  
icw2a 2.mod Updated version of IC-W2 extended xmit mod  
kamdcd.mod KAM hf carrier detect mod.  
ken mic.mod KENWWOD MIC MODIFICATION.  
maxtrac.mod Re: Any info on Moto gear for 902mhz FM?  
micor.mod Motorola Micor Repeater Conversion  
micordup.mod Conversion of MICOR UHF to duplex mobile (long!)  
micoruhf.mod MICOR UHF mobile to repeater conversion instructions  
(long!)  
micorvhf.mod MICOR VHF mobile to repeater conversion instructions  
(long!)  
modserv.mod mods database server  
mr8100.mod Re: Uniden MR8100  
pagers.mod BRAVO pagers - undocumented test features  
pk232lok.mod PK-232 Lockup Cures  
pro2004.mod PRO-2004 MODS HERE THEY ARE !!!  
pro2005.mod 2004/2005 modifications  
pro2006.mod Re: PRO-2006  
pro200sb.mod Pro2005/6 SSB MOD HERE!  
pro2020.mod PRO 2020 SCANNER MOD  
pro2022.mod Realistic PRO-2022 Cellular Restoration  
pro2026.mod PRO-2026 MODS!!!  
pro34.mod PRO-34 Scanner Modifications  
pro37.mod PRO-37 Scanner Modifications (Long)  
pro38.mod A (useless?) modification for the PRO-38  
pro42aus.mod Re: Mods for PRO-43  
pro43.mod Improved audio for the PRO-43 portable scanner  
pro43 1.mod TWO frequency mods for the PRO-43  
pro43 2.mod Improved audio for the PRO-43 portable scanner  
pro43mtr.mod PRO-43 S-Meter!  
ps50.mod PS50 fix  
r5000.mod R5000  
r7000.mod R7000 Display/Sensitivity Problem  
r7000 2.mod R7000 modifications  
rad mods.mod [rec.radio.amateur.misc] Radio Mods  
rci2950.mod Mods for RCI-2950  
rci 2950.mod Re: Mods for RCI-2950  
scanner.mod Squelch Improvements for Scanners  
sony2010.mod Sony 2010 repair/mod  
tapr9600.mod TAPR 9600 MODEM MODS PART 1  
tc2duplx.mod TNC2 Duplex Mod  
th215.mod Kenwood TH-215A modification  
th225.mod Re: Kenwood TH225A modifications wanted  
th25.mod Kenwood HT-45A mods? ( and TH-25AT )  
th26.mod Re: Needed: Kenwood TH-26A and TH-46A Mods  
th27a.mod TH27a Mods  
th28a.mod Kenwood TH28A Mods (here they are)  
th75.mod KENWOOD TH-75A MOD  
th77a.mod Here are the Kenwood TH-77A mods!  
th78 new.mod TH78 mods for newer radios  
th78a 0.mod Guide to TH-78A Undocumented Features  
th78a 1.mod Re: Kenwood TH-78 mods / Game



th78a 2.mod TH78A mod file, crossband repeat, extended RX/TX,  
cloning  
th78a 3.mod More TH 78 Mods  
th78warn.mod KENWOOD TH-78A MOD WARNING  
tiny2tnc.mod tiny-2 tnc fix  
tm221.mod TM221a, no TX in high power mode fix  
tm241.mod TM421a TX mod file  
tm2530.mod TM-2530/2550/2570 MARS/CAP  
tm2570a.mod TM-2530/2550/2570 MARS/CAP  
tm321a.mod TM321A Mars/cap mod  
tm321a 2.mod TM321a weak mic audio fix  
tm321a 3.mod packet mod for TM321  
tm421.mod TM421a TX mod file  
tm421a.mod TM421a TX mod file  
tm701.mod TM701A CROSSBAND MOD  
tm701a.mod Kenwood TM701A mods  
tm721.mod TM721 modification  
tm721 2.mod Re: Kenwood TM-621,721 mods ?  
tm721 3.mod TM-721A UHF Extend Mod  
tm731.mod TM-731A RPTR & OUT-OF-BAND MODS  
tm732a 1.mod Kenwood TM-732A Extended Receive Mod  
tm732a 2.mod TM-732A MODIFICATION MATRIX  
tm741.mod TM-741 Mod  
tm741732.mod Undocumented Kenwood Features/Games TM-741/TM-732  
tm741 1.mod Kenwood TM-741a GAME Dox!!  
tm741 2.mod Kenwood 741 Out of Band Problem  
tm742.mod TM-742/942 Remote Control  
tm941a.mod TM941a mod  
tm941a 2.mod Kenwood TM-941A UNDOCUMENTED FEATURE  
tm 96kb.mod TM621 721 731 9600 baud mod file  
tnc2.mod RELIABILITY MOD FOR TAPR-2's  
tnc2a.mod Cleaning up MFJ 1270B  
tr2400.mod TR2400 repair notes, unwanted noise, low RX, display & keyboard  
tr7625.mod TR7625 intermittant TX fix  
ts140.mod TS-140S TX All Freq Mod  
ts180.mod TS180s notes (long)  
ts2545at.mod TH25 and 45 automatic power off defeat  
ts430.mod Trio - Kenwood TS430 extended coverage  
ts430 2.mod TRANSMIT ENABLE FOR MARS AND CAP FREQUENCIES FOR THE  
TS430S  
ts440.mod KENWOOD TS-440 Mod  
ts440 1.mod TS440 receiver audio mods file  
ts440\_at.mod TS-440S MODIFICATION TO USE ANTENNA TUNER FOR XT AND  
RX.-  
ts450690.mod TS450 and TS690 TX mod file  
ts50.mod TS-50 Power Mod for QRP  
ts520.mod TS520 service notes  
ts530.mod TS530 WARC bands mod file  
ts680.mod TS680 Freq Extend mod  
ts680 2.mod Kenwood TS-680 mods  
ts711.mod Kenwood TS-711A Mod  
ts790a.mod TS-790A X-Band Repeat Mod  
ts820.mod TS820 Receive AUX band installation  
ts830.mod TS830 frequency shift, low volt fix  
ts850 1.mod TS850S features and mod file (long)  
ts850 2.mod Re: TS850S features and mod file (long)  
ts850s.mod TS850S features and mod file (long)

ts930.mod    MODS for KENWOOD TS-930 Transcievers =====  
ts940.mod    TS940s erratic display or control fix  
ts940ibm.mod        TS-940 Control Program  
tw 4000.mod        Mod for Kenwood TW-4000 for CAP  
u2at.mod        Extended xmit mod for the Icom IC-u2AT handheld  
uni2510.mod        Mod file: Uniden 2510 AGC speed mod for packet



From: wa2ise@cbnewsb.cb.att.com (robert.f.casey)  
Newsgroups: rec.radio.amateur.misc  
Subject: Alinco DJ120 extended transmit mod file  
Keywords: mods  
Message-ID: <1991Dec1.185708.23870@cbfsb.att.com>  
Date: 1 Dec 91 18:57:08 GMT  
Sender: news@cbfsb.att.com  
Organization: AT&T Bell Laboratories  
Lines: 19

copied from packet:

Sb: MOD FOR ALINCO DJ-120

HI ALL, I HAVE RECENTLY HEARD OF A MOD FOR THE ALINCO DJ-120. THE MOD OPENS UP TRANSMIT FROM 130 MHZ TO 174 MHZ. TO DO THIS, PLEASE FOLOW THESE SIMPLE PROCEDURES:

- 1) OPEN THE FRONT AND TOP CASE OF THE HT.
  - 2) LOOK FOR 2 JUMPERS, ONE VERTICAL, ONE HORIZONTAL NEXT TO THE MICROPROCESSOR AND CUT BOTH OF THEM.
  - 3) RESET THE MICROPROCESSOR BY PRESSING THE RESET BUTTON ON FRONT PANEL.
- \*\*\* BE CAREFUL! THAT WILL RESET ALL MEMORIES STORED IN THE RADIO \*\*\*

THAT'S ALL! I TRIED IT OUT ON MY HT, AND IT WORKES GREAT!  
N2LPD@N2IMC.NJ.U.S.A.NA 73 DE MIKE, N2LPD

=====  
Note: I haven't tried or verified this, proceed at your own risk.  
And don't transmit outside of legal bands! WA2ISE



From: ds1437%BROCK1P.BITNET@cornellc.cit.cornell.edu  
Subject: DJ-160 MODS  
Date: 8 Jun 91 08:30:59 GMT  
Organization: UCSD Usenet Gateway  
Lines: 64

The new Alinco DJ-160 Radio will receive between 137-174 Mhz, and transmit in the 2Meter band only (144-148Mhz). A simple modification to the radio will enable it to transmit in the full range it receives currently. I have not tested the output power on other frequencies (Due to my one and only watt meter getting fried) however I have tried setting a weather receiver a small distance away, and I did hear the radio in the receiver. To make the mod, the following must be done: (I assume that you have some experience with electronics and that you can tell a wire from a resistor, from a transistor)

- 1) Take the battery of the radio by lifting the battery release button. If you look at the bottom of the radio, there will be a metal plate that is held on with 4 small screws. Take this plate off, noting exactly how the clip was held on (like the slot for the battery release clip)
- 2) On the back of the radio there are two screws that hold the back of the radio on, take these screws out.
- 3) Now you should be able to lift the bottom part of the radio by the battery release button slightly apart. I was told that you should take the top knobs off, but I found that I didn't have to.
- 4) If you take the Battery Release Button and turn it about 90 degrees, the button should come out easily. After you get the small piece of plastic that is the button, you should see a yellow wire behind where the clip was.
- 5) Take a small wire cutter and CUT this YELLOW wire. You should probably make sure that the wire doesn't have bare metal showing from a lousy cutter, because I don't think that grounding this wire to the case would be HEALTHY for your radio. :-)
- 6) After You cut this wire. Assemble the radio, and just before you turn on the radio, do a power reset by holding the FUNC button while turning on the radio. This will reset the radio to ALL of the factory set parameters. YOU WILL LOOSE PROGRAMMED FREQUENCIES that were programmed into the memory mode of the radio, so just write the frequencies down before proceeding with the above instructions.
- 7) The radio should be just like new, except that the transmit will be enabled for ALL frequencies! GOOD Luck!

If you use these mods for ILLEGAL purposes, pity upon thy sole, for you do not belong in the ranks of Amateur Radio. This information is only supplied for Legal and Informational Purposes

only and I can NOT be held responsible for anything that you do with this INFO. And if you are an idiot and screw up your radio by your own stupididy, TOO BAD. I can't be held responsible for my own actions anyhow, so as Brian@ucsd.edu would say, "So There!"

```
*****  
Name: Donald L. Schleede                               Snail-Mail:  
Call: KB2LZF                                           Dept. Earth Sciences  
E-mail Addresses:                                     SUNY Brockport  
  ds1437%brocklp@cornellc.cit.cornell.edu             Brockport, NY 14420  
  dschleede@unidata.ucar.edu                          Twisted Pair:  
  root@kazumi.UUCP                                    (716) 395-5760  
Planet: Earth  
*****
```





From: RON@NSULA.EDU (Ron Wright - NSU Computer Center)  
Newsgroups: rec.radio.amateur.misc  
Subject: Alinco DJ-162 Mod - (Here's How)  
Date: 28 Apr 93 13:19:50 GMT  
Organization: UCSD Usenet Gateway  
Lines: 38  
Message-ID: <930428081950.62eb@NSULA.EDU>  
NNTP-Posting-Host: ucsd.edu  
Originator: daemon@ucsd.edu

I requested this mod from the net several times and received no responses. This morning I see were NORWZ has posted his luck with a similar inquiry. Well, I finally found it so here it is.

Extended RX/TX for Alinco DJ-162

1. Remove the battery pack.  
Remove the battery plate from the bottom of the radio.
2. Remove the back cover from the radio.  
This is a tedious process. You must take the knobs off the top and remove the top plate first.
3. Under the Battery clasp on the side of the radio  
(The little sliding thumb switch that keeps the

battery

from falling off the radio)

small

you will find a yellow loop of wire. This loop is

and hard to get to. You will need a very small pair of cutters or scissors.

--Cut this wire.

4. Put the radio back together
5. Reset the radio. (You will lose your memories)
6. Go to the VFO mode.  
Pressing the 'B' key on the keypad will now allow you to cycle through the extended rx bands. It will cycle from 2 mtrs, am aircraft, to 800. The radio does NOT have the guts to receive 800. It just

happens

listening.

to be in the processor so don't waste your time

7. This same jumper also opens extended transmit.

Hope this helps out...

Ron Wright - KA5LUG  
RON@ALPHA.NSULA.EDU



From: n2kzh@kblbd.nj.usa.na (Bryan Todd)  
Subject: DJ500 Mod

THIS MOD IS FOR THE ALINCO DJ-500T, IF YOU HAVE LITTLE OR NO SOLDERING EXPERIENCE DO NOT !!! REPEAT DO NOT TRY THIS MOD ON YOUR RADIO. IT IS NECESSARY TO REMOVE A CHIP RESISTOR FROM THE CPU BOARD.

TOOLS YOU WILL NEED: # 0 PHILLIPS SCREWDRIVER  
25 WATT SOLDERING PENCIL,  
EXACTO KNIFE.

I RECEIVED A SCHEMATIC AND BOARD LAYOUT FROM ALINCO FREE. PHONE 1-213-618-8616. OR SEND A SASE TO ME AT : BRYAN TODD 318 ALDRICH ROAD HOWELL, NJ 07731 AND I WILL SEND YOU A COPY OF THE BOARD LAYOUT.

1. REMOVE THE BATTERY PACK
2. REMOVE 3 SCREWS FROM THE BACK OF THE RADIO
3. REMOVE 2 SCREWS FROM THE BOTTOM (FRONT PANEL SIDE)
4. SPLIT THE CASE CAREFULLY.
5. PUT THE RADIO FACE DOWN ON THE TABLE WITH THE TOP AWAY FROM YOU.  
THE SPEAKER AT THE BOTTOM.
6. FIND THE "D" SHAPED GOLD PADS UNDER THE SPEAKER ON THE RIGHT SIDE OF BOARD.
7. THE CHIP RESISTOR IS TWO PADS UP FROM THE "D" SHAPED ONES.  
THE NEXT STEPS CAN CAUSE GREAT ILLNESS TO THE RADIO !!!!!
8. VERY CAREFULLY HEAT ONE END OF THE CHIP AND PRY WITH KNIFE.
9. THEN HEAT THE OTHER END AND REPEAT UNTIL RESISTOR IS OFF THE BOARD.
10. HOLD THE BATTERY PACK IN CONTACT WITH BOTTOM OF RADIO, TURN ON RADIO,  
PRESS THE RESET BUTTON WITH TOOTHPICK (HOLE UNDER PTT SWITCH).
11. CHECK THAT YOU HAVE THE NEW FREQUENCIES THEN REASSEMBLE THE RADIO.

YOU CAN NOW PROGRAM  
130.00 MHz TO 169.995 MHz  
340.00 MHz TO 379.995 MHz  
420.00 MHz TO 469.995 MHz  
870.00 MHz TO 899.995 MHz

WARNING !!!!!!! TRANSMITTING OUT OF THE HAM BANDS IS ILLEGAL !!!!!!!

SINCE YOU HAVE THE SOLDERING IRON HOT YOU CAN BUILD A NICE ACCESSORY.  
REMOTE MICROPHONE AND SPEAKER.

TO MAKE A CABLE YOU HAVE TO BUY:  
1/8" STEREO PLUG "RS #274-284"  
1/8" TO 3/32" STEREO ADAPTER "RS # 274-373"  
10 K OHM 1/4 WATT RESISTOR "RS # 271-1335"  
10 MICROFARAD 35 VOLT CAP "RS # 272-1013"  
MATE PLUG FOR YOUR SPARE MICROPHONE.  
PLASTIC MINI BOX.

I MADE ONE WITH A 8 PIN STANDARD MIC PLUG SO I CAN USE MY SPARE HAND MIC IN THE CAR WITH A 6" SPEAKER.

SPEAKER MIC CONNECTIONS:

SHELL        GROUND  
TIP         REC AUDIO  
RING        PTT & AUDIO IN.

CONNECT SHIELD, PTT COMMON AND SPEAKER COMMON TO THE SHELL. CONNECT SPEAKER PLUS TO THE TIP. CONNECT A 10K OHM RESISTOR AND 10 MICROFARAD CAP TO THE RING. CONNECT THE PTT SWITCH BETWEEN THE SHELL AND THE 10K RESISTOR. CONNECT THE MIC PLUS TO THE 10 MICROFARAD CAP. NOW YOU CAN USE A REAL SPEAKER AND REAL MICROPHONE. THAT WILL ALSO WORK FOR PACKET BUT USE A .1 MICROFARAD CAP NOT 10 MF....

```
|_____| SHELL
| |
| | ring
V tip
```

WELL THATS ALL FOLKS..... 73'S FROM BRYAN (N2KZH)

-----  
Note: I haven't tried or verified this, proceed at your own risk. WA2ISE

-----



From: steuer@clam.rutgers.edu (robert Steuer)  
Newsgroups: rec.radio.amateur.misc  
Subject: UPDATE: MOD for 800MHz RX on DJ-560!  
Message-ID: <Feb.16.15.01.03.1993.26776@clam.rutgers.edu>  
Date: 16 Feb 93 20:01:03 GMT  
Organization: Rutgers Univ., New Brunswick, N.J.  
Lines: 28

Here is the mod for the DJ-560. I haven't had my friend try it yet,  
but thanks anyway to Kevin Jessup for supplying the information!!

There is NO mod required to do crossband repeat. It is a standard  
feature. If crossband repeat operates on the 800 MHz band (after  
the modification), that is another matter!

Performing the aircraft mod (as described in the back of the owners  
manual, also gets you 800 Mhz).

BTW, cutting the RED jumper provides AIRCRAFT and 800 MHz.  
Cutting the BLUE wire provides out of band transmit (but NO  
guarantess that performance will be within amateur band specs).

To enable 800 MHz, press the UHF key 3 times (to guarantee that your  
are in UHF VFO mode). Then press the function key (keep it held  
down) and then press UHF.

Have fun!

--

Kevin Jessup, kevin.jessup@mixcom.mixcom.com

"Friends don't let friends run DOS."

-- Microware

Thanks Again Kevin! Rob KF2EK



From : N6ZXY @ W6QFK.#SOCA.CA.USA.NA  
To : MODS @ ALLUS  
Date : 920212/0600  
Msgid : BF 4926@W6QFK, 5905@W6VIO \$4926\_W6QFK  
Subject: Mod for ALINCO DJ-580T D/B HH

Hello to all, name here is Tom. This letter is to let you know how to Modify your ALINCO DJ-580T Dual band Handheld. This seems to be a very good radio in form and function, and does not contain any of the previous glitches that I have found on earlier models of Alinco radios. This Mod comes straight from Alinco in Torrance Ca.

A L I N C O D J - 5 8 0 T A I R & O U T O F B A N D

=====

This is a very simple mod it will give you aircraft band RX, from 108-130 Mhz AM. On the first part and RX/TX from 130Mhz-170Mhz on VHF and 415 - 470 Mhz on UHF (Approximate).

1. Remove the battery from the radio.
2. Look at the bottom of the radio where the battery mounts.
3. Locate four screws that hold the battery mounting plate to the bottom of the radio. Remove these four screws.  
(Be careful, the screws are SMALL!)
4. The battery plate is still attached by two wires but there should be enough slack in them to get around the plate with a pair of cutters.
5. With the radio's keypad and display facing up, locate a loop of red wire on the right side of the radio interior.
6. Cut this wire for AM Aircraft band RX.
7. On the left side of the interior, locate a loop of blue wire.
8. Cut this wire for TX/RX as described above.
9. Insulate the exposed ends of these wires so they do not short.
10. Re-attach the battery mounting plate and replace the battery.
11. With the radio off, hold down the function key and turn the radio on.

Thats all there is to it! You can now program all frequencies Within the above ranges. The AIR band RX is pretty hot Attempt this modification at your own risk. It may void any warranty your equipment may carry.

73 de Tom/N6ZXY@W6QFK.#SOCA.CA.USA.NA





Subject: DJ580 Mod

Revision 3.0 August 25,1992

To all of my friends that I have spoken with throughout the world, I give you the final version of the DJ-580 handheld radio "Users Manual". I have sifted through this manual once again and restructured some areas while improving the index. You now have in your hands a manual that took over 250 hours to prepare and maintain. This does not include the hundreds of telephone calls that I have taken collectively either at home or at work. I dedicate this manual to those amateurs who have spent long and endless hours trying to understand what their radio does. I would like to thank ALINCO ELECTRONICS for their support. Without this support there would be no manual. Finally, I would like to thank my family for their endless patience during this project.

#### About the Author

Jay Appell, KA1SNA, brings a new style to amateur radio documentation. His conversational and personal style will put you, the "User" back into the "Users Guide". Jay was a member of the FCC Personal Users Radio Advisory Committee (PURAC).

Jay started in radio broadcasting at the age of 11. His broadcast career extended through 1975 where he left for the field of computers. Jay joined Data General Corporation in 1978 where he worked as a field and systems technical support engineer. He left DGC in 1987 for Stratus Computer where he now works in the North American customer service center as a Senior Technical Support Engineer.

Jay currently operates his own consultation company in Hopedale Massachusetts and consults with companies such as Alinco Electronics as a technical support writer and advisor.

If you would like to drop Jay some electronic mail, send it to:

Jay\_Appell@cac.stratus.com

Opening Page a

|   |                                                     |    |
|---|-----------------------------------------------------|----|
| 1 | INTRODUCTION. . . . .                               | 1  |
|   | 1.1 STANDARD ACCESSORIES . . . . .                  | 1  |
|   | 1.2 OPTIONAL ACCESSORIES . . . . .                  | 1  |
| 2 | SPECIFICATIONS. . . . .                             | 2  |
|   | 2.1 GENERAL SPECIFICATIONS . . . . .                | 2  |
|   | 2.2 AMERICAN FREQUENCY COVERAGE. . . . .            | 2  |
|   | 2.3 EUROPEAN FREQUENCY COVERAGE. . . . .            | 2  |
|   | 2.4 TRANSMITTER SPECIFICATIONS . . . . .            | 3  |
|   | 2.5 RECEIVER SPECIFICATIONS. . . . .                | 3  |
|   | 2.6 BATTERY SPECIFICATIONS . . . . .                | 3  |
|   | 2.6.1 EBP-20N BATTERY SPEC. . . . .                 | 3  |
|   | 2.6.2 EBP-22N BATTERY SPEC. . . . .                 | 4  |
|   | 2.7 GENERAL POWER READINGS . . . . .                | 4  |
| 3 | DESCRIPTIONS. . . . .                               | 4  |
|   | 3.1 FRONT PANEL CONTROLS/FUNCTIONS . . . . .        | 5  |
|   | 3.1.1 LCD DISPLAY PANEL . . . . .                   | 5  |
|   | 3.1.2 CONTROL KEYPAD. . . . .                       | 5  |
|   | 3.1.3 MICROPHONE. . . . .                           | 5  |
|   | 3.1.4 SPEAKER . . . . .                             | 5  |
|   | 3.1.5 VHF BAND KEY. . . . .                         | 5  |
|   | 3.1.6 UHF BAND KEY. . . . .                         | 5  |
|   | 3.1.7 SHIFT KEY . . . . .                           | 5  |
|   | 3.1.8 STEP KEY. . . . .                             | 6  |
|   | 3.1.9 REV KEY . . . . .                             | 7  |
|   | 3.1.10 TONE KEY. . . . .                            | 8  |
|   | 3.1.11 PO KEY. . . . .                              | 8  |
|   | 3.1.12 T.SQL KEY . . . . .                          | 9  |
|   | 3.1.14 TMS KEY . . . . .                            | 10 |
|   | 3.1.15 APO KEY . . . . .                            | 10 |
|   | 3.1.16 DOWN ARROW AND FL/PL KEY. . . . .            | 11 |
|   | 3.1.17 DUAL KEY. . . . .                            | 11 |
|   | 3.1.18 UP ARROW AND MESS KEY . . . . .              | 12 |
|   | 3.1.19 PRI/DIAL M KEY. . . . .                      | 12 |
|   | 3.1.20 GP DSQ/DSQS KEY . . . . .                    | 12 |
|   | 3.1.21 SKIP/M TO V KEY . . . . .                    | 12 |
|   | 3.1.22 MR/MW KEY . . . . .                          | 13 |
|   | 3.1.23 SCN/PS KEY . . . . .                         | 13 |
|   | 3.1.24 CALL/CALL.W KEY . . . . .                    | 14 |
|   | 3.1.25 LAMP KEY. . . . .                            | 14 |
|   | 3.1.26 MONI/BS KEY . . . . .                        | 14 |
|   | 3.2 TOP PANEL CONTROLS/FUNCTIONS . . . . .          | 15 |
|   | 3.2.1 BNC ANTENNA CONNECTOR . . . . .               | 15 |
|   | 3.2.2 VHF VOLUME CONTROL. . . . .                   | 15 |
|   | 3.2.3 VHF SQUELCH . . . . .                         | 15 |
|   | 3.2.4 POWER ON/OFF AND UHF VOLUME CONTROL . . . . . | 15 |

|       |                                        |    |
|-------|----------------------------------------|----|
| 3.2.5 | UHF SQUELCH . . . . .                  | 15 |
| 3.2.6 | MAIN TUNING DIAL. . . . .              | 15 |
| 3.2.7 | SPEAKER JACK. . . . .                  | 16 |
| 3.2.8 | MIC JACK. . . . .                      | 16 |
| 3.2.9 | V.U.SPEAKER JACK. . . . .              | 16 |
| 3.3   | LEFT SIDE CONTROLS/FUNCTIONS . . . . . | 16 |
| 3.3.1 | FUNCTION KEY. . . . .                  | 16 |
| 3.3.2 | PTT SWITCH. . . . .                    | 16 |
| 3.3.3 | BATTERY LOCK BUTTON . . . . .          | 17 |

Table of Contents Page b

|        |                                                    |    |
|--------|----------------------------------------------------|----|
| 3.4    | RIGHT SIDE CONTROLS/FUNCTIONS. . . . .             | 17 |
| 3.4.1  | DC IN JACK. . . . .                                | 17 |
| 3.5    | LCD DISPLAY DESCRIPTIONS . . . . .                 | 17 |
| 3.5.1  | MEMORY CHANNEL. . . . .                            | 17 |
| 3.5.2  | BATTERY SAVE. . . . .                              | 17 |
| 3.5.3  | TONE ENCODER/TONE SQUELCH . . . . .                | 17 |
| 3.5.4  | PRIORITY/DUAL WATCH . . . . .                      | 18 |
| 3.5.5  | AM. . . . .                                        | 18 |
| 3.5.6  | SPLIT . . . . .                                    | 18 |
| 3.5.7  | TIMER SCAN. . . . .                                | 18 |
| 3.5.8  | OUTPUT POWER. . . . .                              | 18 |
| 3.5.9  | DIALER. . . . .                                    | 18 |
| 3.5.10 | SHIFT . . . . .                                    | 18 |
| 3.5.11 | DSQ . . . . .                                      | 18 |
| 3.5.12 | VHF . . . . .                                      | 18 |
| 3.5.13 | FREQUENCY INDICATOR . . . . .                      | 18 |
| 3.5.14 | AUTO POWER OFF (APO). . . . .                      | 18 |
| 3.5.15 | ON AIR. . . . .                                    | 18 |
| 3.5.16 | S/RF. . . . .                                      | 19 |
| 3.5.17 | FREQUENCY DECIMAL POINT . . . . .                  | 19 |
| 3.5.18 | TONE FREQUENCY DECIMAL POINT. . . . .              | 19 |
| 3.5.19 | PL (PTT LOCK) . . . . .                            | 19 |
| 3.5.20 | FL (FREQUENCY LOCK) . . . . .                      | 19 |
| 3.5.21 | UHF . . . . .                                      | 19 |
| 4      | GETTING STARTED (RECEIVING) . . . . .              | 19 |
| 4.1    | KEY PAD DIRECT ENTRY . . . . .                     | 20 |
| 4.2    | STEP KEY . . . . .                                 | 21 |
| 4.3    | CLEARING ENTRY . . . . .                           | 22 |
| 4.4    | MONO BAND FUNCTION . . . . .                       | 22 |
| 5      | TRANSMITTING. . . . .                              | 22 |
| 5.1    | POWER OUTPUT SETTING . . . . .                     | 22 |
| 5.2    | LOW LEVEL BATTERY MODE . . . . .                   | 23 |
| 6      | TRANSCEIVER MODES . . . . .                        | 23 |
| 6.1    | VFO MODE (Variable Frequency Oscillator) . . . . . | 23 |
| 6.2    | MEMORY MODE. . . . .                               | 23 |
| 6.2.1  | PROGRAMMING A MEMORY CHANNEL (MW KEY) . . . . .    | 23 |
| 6.2.2  | SCROLL MEMORY . . . . .                            | 24 |
| 6.2.3  | CANCELING A MEMORY CHANNEL. . . . .                | 25 |
| 6.2.4  | ALLOCATION OF MEMORY CHANNELS . . . . .            | 25 |
| 6.2.5  | MEMORY TO VFO COPY FUNCTION . . . . .              | 26 |
| 6.3    | CALL MODE. . . . .                                 | 26 |

|       |                                      |    |
|-------|--------------------------------------|----|
| 6.3.1 | PROGRAMMING THE CALL CHANNEL (W KEY) | 26 |
| 6.3.2 | ACTIVATING CALL CHANNEL              | 27 |
| 6.3.3 | CALL CHANNEL TO VFO COPY FUNCTION    | 27 |
| 7     | PRIORITY FUNCTIONS                   | 27 |
| 7.1   | VFO PRIORITY                         | 27 |
| 7.2   | MEMORY PRIORITY                      | 28 |
| 7.3   | CALL PRIORITY                        | 28 |
| 7.4   | DUAL WATCH FUNCTION                  | 29 |
| 7.4.1 | VFO/MEMORY DUAL WATCH                | 29 |
| 7.4.2 | CALL/VFO DUAL WATCH                  | 30 |
| 7.4.3 | CALL/MEMORY DUAL WATCH               | 30 |

Table of Contents Page c

|        |                                           |    |
|--------|-------------------------------------------|----|
| 8      | SCANNING FUNCTIONS                        | 30 |
| 8.1    | VFO SCAN                                  | 31 |
| 8.1.1  | PROGRAM BAND SCAN MODE (VFO MODE)         | 31 |
| 8.2    | MEMORY SCAN MODE                          | 32 |
| 8.2.1  | MEMORY CHANNEL SKIP MODE                  | 33 |
| 8.3    | SCANNING TYPES                            | 33 |
| 8.4    | OTHER SCANNING INFORMATION                | 33 |
| 8.4.1  | DUAL BAND SCAN                            | 33 |
| 8.4.2  | DUAL BAND SCANNING WITH MEMORY PRIORITY   | 34 |
| 9      | REPEATER OPERATIONS                       | 34 |
| 9.1    | SPLIT FREQUENCY FUNCTION                  | 34 |
| 9.1.1  | VFO MODE SPLIT                            | 34 |
| 9.1.2  | MEMORY MODE SPLIT                         | 35 |
| 9.2    | REV KEY                                   | 35 |
| 9.3    | RESETTING RADIO                           | 35 |
| 9.4    | CTCSS ENCODE/DECODE                       | 36 |
| 10     | AUTOPATCH OPERATION (AUTOMATIC DIALER)    | 37 |
| 10.1   | PROGRAM AUTODIAL NUMBER                   | 37 |
| 10.2   | CLEAR DIALER MEMORY                       | 37 |
| 10.3   | CORRECTING CODES IN DIALER MEMORY         | 37 |
| 10.4   | TRANSMIT/CHANGE AUTODIAL NUMBER           | 38 |
| 10.5   | MANUAL DIAL                               | 39 |
| 10.6   | DISABLE AUTODIAL                          | 39 |
| 10.7   | DIALER RATE ADJUST                        | 39 |
| 11     | DIGITAL SQUELCH (DSQ)                     | 40 |
| 11.1   | DSQ SCHEME                                | 40 |
| 11.2   | PROGRAMMING ALL DSQ CODES                 | 41 |
| 11.3   | DSQ MODES                                 | 42 |
| 11.3.1 | TRANSMITTING (CODE SQUELCH)               | 43 |
| 11.3.2 | RECEIVING (CODE SQUELCH)                  | 43 |
| 11.3.3 | TRANSMITTING (GROUP CALLING)              | 43 |
| 11.3.4 | RECEIVING (GROUP CALLING)                 | 44 |
| 11.3.5 | TRANSMITTING (PRIVATE CALLING IN A GROUP) | 44 |
| 11.3.6 | RECEIVING (PRIVATE CALLING IN A GROUP)    | 44 |
| 11.3.7 | TRANSMITTING (PRIVATE CALL)               | 45 |
| 11.3.8 | RECEIVING (PRIVATE CALL)                  | 45 |
| 11.4   | ERROR CODE                                | 45 |
| 11.5   | TIMING CONSIDERATIONS                     | 45 |

|        |                                                      |    |
|--------|------------------------------------------------------|----|
| 11.6   | DSQ WILDCARDS . . . . .                              | 46 |
| 11.7   | DIGITAL SIGNAL MESSAGE . . . . .                     | 46 |
| 11.7.1 | TRANSMITTING DIGITAL SIGNAL MESSAGE. . . . .         | 47 |
| 11.7.2 | RECEIVING DIGITAL SIGNAL MESSAGE . . . . .           | 47 |
| 11.7.3 | TRANSMITTING WITH DIGITAL SIGNAL DISPLAYED . . . . . | 47 |
| 11.7.4 | REVIEW DIGITAL SIGNAL MESSAGE MEMORY . . . . .       | 47 |
| 11.7.5 | CLEARING MESSAGE MEMORY. . . . .                     | 48 |
| 12     | CROSS BAND REPEATER . . . . .                        | 48 |
| 12.1   | ACTIVATE CROSS BAND REPEATER . . . . .               | 48 |
| 12.2   | DEACTIVATE CROSS BAND REPEATER . . . . .             | 48 |

Table of Contents Page d

|      |                                         |    |
|------|-----------------------------------------|----|
| 13   | FULL DUPLEX OPERATION . . . . .         | 49 |
| 13.1 | ENABLE SPEAKER FULL-DUPLEX . . . . .    | 49 |
| 13.2 | DISABLE SPEAKER SEMI-DUPLEX. . . . .    | 49 |
| 14   | AIRCRAFT RECEIVE MODIFICATION . . . . . | 50 |

Table of Contents Page e

1 INTRODUCTION

We at Alinco would like to thank you for purchasing the ALINCO DJ-580T (US Model)/DJ-580E (European Model). Radios and other products made by ALINCO rank as some finest in the world. Your DJ-580T/E has been manufactured and tested very carefully at the factory and will give you satisfactory operation for many years. We are confident that you will be very satisfied with your choice of this fine ALINCO radio.

1.1 STANDARD ACCESSORIES

When you unpack your ALINCO transceiver, you will find the standard accessories which include:

1. Ni-Cad Battery Pack (7.2V @ 700mAH).EBP-20N
2. AC Wall Charger..(120V)DJ-580/T.....EDC-24
3. Belt Clip
4. Hand Strap
5. Dual Band Rubber Flex Antenna
6. Schematic Diagram
7. Instruction Manual
8. Warranty registration card

1.2 OPTIONAL ACCESSORIES

To enhance your DJ-580 radio further, optional accessories are available. At ALINCO, we strongly recommend that you purchase appropriate accessories to get full features and performance from your radio.

1. Ni-Cad Battery Pack (7.2V @ 700mAH).EBP-20N
2. Ni-Cad Battery Pack (12V @ 700mAH) .EBP-22N
3. Dry Cell (6-AA) Pack . . . . .EDH-6
4. Quick Ni-cad battery charger . . . .EDC-34

- 5. Mobile DC Power Cable/Noise Filter .EDC-36  
w/o Noise Filter .EDC-43
- 6. Earphone . . . . .EME-6
- 7. DC cable for power supply. . . . .EDC-37
- 8. Earphone/Earphone. . . . .EME-6
- 9. Earphone/Microphone w PTT. . . . .EME-11
- 10. Speaker/Microphone . . . . .EMS-2Z
- \*11. Remote Control Speaker/Microphone. .EMS-8Z
- 12. Headset with PTT/VOX . . . . .EME-10K
- 13. Soft Case. . . . .ESC-17 for EBP-20N or EDH-6
- 14. Tone Squelch Unit. .(580-E). . . . .EJ-12U

\* = This Speaker/Mic has 3 keys. One key is marked with an up arrow, another with a down arrow. These are used to increment and decrement frequency or memory channel. The last key is labeled "A" and toggles between the memory and VFO function.

2 SPECIFICATIONS

The specifications outlined for this product are for use in the amateur bands only. No guarantee or warranty, either specific or implied, will apply to any function or specification outside the amateur bands. Individual radios may experience different performance and/or specification levels. All specifications and features are subject to change without notice or obligation.

2.1 GENERAL SPECIFICATIONS

Channel Spacing: 5, 10, 12.5, 15, 20, 25 KHz  
steps

Memory Channels: 42 Channels (20 VHF, 20 UHF)  
1 VHF Call Channel  
1 UHF Call Channel

Antenna Impedance: 50 Ohms unbalanced

Microphone Input Impedance: 2K Ohms

Signal Type: F3

Power Supply Requirements: 13.8 Volts DC

Dimensions (Radio Only):  
Height = 140mm (4 1/8")  
Width = 58mm (2 1/2")  
Depth = 33mm (1 1/2")

Weight: Approximately 410g

DTMF: 16 Button Key Pad

Subaudible Tones: Encode and Decode installed

2.2 AMERICAN FREQUENCY COVERAGE

The frequency coverage listed as follows applies to the DJ-580T.



VHF Band: 144.000 - 147.995 MHz (TX)  
 130.000 - 173.995 MHz (RX)  
 110.000 - 173.995 MHz (RX)\* Only after Modification  
 UHF Band: 440.000 - 449.995 MHz (TX)  
 420.000 - 479.995 MHz (RX)  
 \*850.000 - 975.000 MHz (RX)\* Only after Modification

\* Band coverage may vary. Refer to subsection 3.5.18 for more information on the "tone frequency decimal point".

### 2.3 EUROPEAN FREQUENCY COVERAGE

The frequency coverage listed as follows applies to the DJ-580E.

VHF Band: 144.000 - 145.995 MHz (TX)  
 130.000 - 173.995 MHz (RX)  
 130.000 - 173.995 MHz (RX)\* Only after Modification  
 UHF Band: 430.000 - 439.995 MHz (TX)  
 420.000 - 479.995 MHz (RX)  
 \*850.000 - 975.000 MHz (RX)\* Only after Modification

\* Band coverage may vary. Refer to subsection 3.5.18 for more information on the "tone frequency decimal point".

Page 2

### 2.4 TRANSMITTER SPECIFICATIONS

Output Power: 2 Watts with Standard EBP-20N Battery  
 5 Watts with Optional EBP-22N Battery  
 Modulation System: Variable reactance FM  
 Max. Freq. Deviation: +/- 5KHz  
 Spurious Emission: Less than 60dB below carrier  
 Tone Frequency: 67.0 to 250.3 Hz (38 selections)  
 DJ-580T (Subaudible Encoding Tone)  
 DJ-580E (1,750 Hz Tone Burst)  
 Microphone: Electret Condenser  
 Operating Mode:  
 Simplex:  
 Duplex: 5KHz steps minimum between 0-15.995 MHz  
 from receiver frequency.  
 CTCSS Encoder: Built-in and included as standard  
 CTCSS Decoder: Built-in and included as standard

### 2.5 RECEIVER SPECIFICATIONS

Receiver System: Superheterodyne, Dual Conversion  
 Sensitivity: 12dB SINAD less than - 15dB per microvolt  
 Intermediate Frequency: VHF - 1st IF 55.05 MHz  
 2nd IF 455 KHz  
 UHF - 1st IF 23.05 MHz  
 2nd IF 455 KHz  
 Audio Power Output: 250 mw (10% Total Harmonic Distortion)  
 Speaker Impedance: 8 Ohms

## 2.6 BATTERY SPECIFICATIONS

The "PO" function selects output power levels. The transmitter output power is determined by battery type and output power setting.

### 2.6.1 EBP-20N BATTERY SPEC

The EBP-20N is supplied with your radio when purchased.

|                             | PO FUNCTION                                                                                                                      |
|-----------------------------|----------------------------------------------------------------------------------------------------------------------------------|
| Battery Capacity:           | 700 mAh                                                                                                                          |
| Output Voltage:             | 7.2 Volts                                                                                                                        |
| PO (Power Output function): | L - 0.25 Watt output power<br>M - 1.00 Watt output power<br>H - 2.50 Watts output power                                          |
| Charge Times and Chargers:  | EDC-34 (120V) Approx. 1 Hour<br>EDC-35 (220V) Approx. 1 Hour<br>EDC-24 (120V) Approx. 14 Hours<br>EDC-25 (220V) Approx. 14 Hours |
| Charging Temperature:       | 0 to +45 Degrees C                                                                                                               |
| Storage Temperature:        | -20 to +45 Degrees C                                                                                                             |

Page 3

### 2.6.2 EBP-22N BATTERY SPEC

The EBP-22N is supplied with your radio when purchased.

|                             | PO FUNCTION                                                                                                                            |
|-----------------------------|----------------------------------------------------------------------------------------------------------------------------------------|
| Battery Capacity:           | 700 mAh                                                                                                                                |
| Output Voltage:             | 12.0 Volts                                                                                                                             |
| PO (Power Output function): | L - 0.25 Watt output power<br>M - 1.00 Watt output power<br>H - 5.00 Watts output power                                                |
| Charge Times and Chargers:  | EDC-34 (120V) Approx. 1.8 Hours<br>EDC-35 (220V) Approx. 1.8 Hours<br>EDC-24 (120V) Approx. 14 Hours<br>EDC-25 (220V) Approx. 14 Hours |
| Charging Temperature:       | 0 to +45 Degrees C                                                                                                                     |
| Storage Temperature:        | -20 to +45 Degrees C                                                                                                                   |

## 2.7 GENERAL POWER READINGS

The author of this manual has made these power readings available to you because of general interest. These readings are approximate and should be treated as such.

Baseline: 7.2 Volt Pack = 8.50 Fresh Charge

Note: All Ratings are in Milliamps and are approximated.

|                         | Low     | High |
|-------------------------|---------|------|
| VHF Only UHF Muted..... | 58-65   | ma   |
| UHF Only VHF Muted..... | 54-57   | ma   |
| Both bands active.....  | 100-105 | ma   |

The following ratings are approximated and based on Both bands active.

|                                | Item rating |       | Total Reading |         |
|--------------------------------|-------------|-------|---------------|---------|
|                                | Low         | High  | Low           | High    |
| Any Key pressed.....           | 3           | 5 ma  | 103           | 109 ma  |
| LMP (Lamp On).....             | 56          | 61 ma | 156           | 162 ma  |
| Squelch open (No volume).....  | 10          | 15 ma | 110           | 119 ma  |
| Squelch open (Full Volume).... | 70          | 77 ma | 170           | 181 ma  |
| Function Button Pressed.....   | .3          | .5 ma | 100.3         | 104.5ma |
| Battery Saver (Deduction)..... | 35          | 70 ma |               | Erratic |

### 3 DESCRIPTIONS

This section will discuss what the function or control is and how to use it. The subsections are broken down into smaller sections for easy access.

#### 3.1 FRONT PANEL CONTROLS/FUNCTIONS

The following descriptions are those functions necessary to utilize full functionality of the DJ/580T/E.

##### 3.1.1 LCD DISPLAY PANEL

Refer to Section 3.5 for further details on the LCD display panel.

##### 3.1.2 CONTROL KEYPAD

The control pad includes 16 multi-functional command keys that control and execute various operations for the DJ-580T/E. It also serves as a DTMF keypad.

##### 3.1.3 MICROPHONE

An electret condenser microphone is built into the front panel. When transmitting, speak directly into the microphone from a distance of approximately 5 inches. The speaker/microphone connectors are labeled as follows:

Smaller Jack

(MIC JACK):                   Tip: PTT Line/Transmit Audio  
                                  Ring: 5VDC (for EME-10K option)  
                                  Sleeve: Signal Ground

Larger Jack

(SPEAKER JACK):               Tip: Receive Audio  
                                  Ring: Remote Control (for EMS-8 option)  
                                  Sleeve: Signal Ground

If you decide to use the V.U.SP jack while using the SPEAKER jack, the VHF audio will not be heard. The VHF audio is routed through the V.U.SP jack.

#### 3.1.4 SPEAKER

The speaker is located below the key pad on the front panel. It's rated at 8 ohms and not in operation when an external speaker is used.

#### 3.1.5 VHF BAND KEY

Pressing this key allows for operation on the 2 meter VHF band.

#### 3.1.6 UHF BAND KEY

Pressing this key allows for operation on the 70 cm UHF band.

#### 3.1.7 SHIFT KEY

The SHIFT KEY is used to change frequency offset and shift. The symbols -, + and star symbol are used to indicate shifts.

Page 5

1. Press and hold the FUNC key, then press the SHIFT key repeatedly until the desired shift appears on the LCD display.

The - symbol indicates that the transmitter will subtract the offset with the transmitted frequency.

The + symbol indicates that the transmitter will add the offset with the transmitted frequency.

The star symbol indicates a split offset. Refer to Section 9.1 for more information.

Simplex operation is active when neither the - or + or star symbol is displayed on the LCD display. If OFF appears in place of the frequency during transmit, the selected frequency is out-of-band.

2. Select the Active Band by pressing the VHF or UHF key. The LCD display returns to frequency.

\*\*\* NOTE \*\*\*

For larger incremental frequency changes press and hold the FUNC key then rotate the Main Tuning dial. This increments the 1MHz digit.

Amateur radio repeaters utilize separate transmitter and receiver sections. The transmitter frequency may be offset either above or below the receive frequency according to repeater coordination conventions. The standard offset for the 2 meter band is 600 Khz. Offset for the 70cm band is 5 Mhz. Offset direction varies according to established band plans.

EXAMPLE: SHIFT

1. Select the Active Band by pressing the VHF or UHF key.
2. Press and hold the FUNC key, then press the SHIFT key. An offset will be displayed on the LCD display.
3. Rotate the Main Tuning dial or press either arrow key to select the desired offset. For larger incremental frequency changes, press the FUNC key then rotate the Main Tuning dial.
4. Select the Active Band by pressing the VHF or UHF key or PTT key to complete offset procedure.

|      | DJ-580T        | DJ-580E             |
|------|----------------|---------------------|
| VHF: | 600 Khz (0.60) | VHF: 600 Khz (0.60) |
| UHF: | 5 Mhz (5.00)   | UHF: 7.6 Mhz (7.60) |

3.1.8 STEP KEY

The STEP function is used to select desired incremental changes of

receive/transmit frequencies, in steps of 5, 10, 12.5, 15, 20 or 25Khz. Get more information on "GETTING STARTED" in section 4. The step rate changes when in other frequency regions (See Aircraft Receive Modification).

1. Select the Active Band by pressing the VHF or UHF key.
2. Press and hold the FUNC key, then press the STEP key. The channel step will change each time the STEP key is pressed. You can also change the channel step by using the Main Tuning dial, UP ARROW or DOWN ARROW keys.
3. Select the Active Band by pressing the VHF or UHF key to set channel step and return to operating frequency.

After channel step is set, the receive/transmit frequency will increase or decrease by the value selected when you turn the

Main Tuning dial.

When the transmit frequency extends beyond permissible limits, Off will be displayed on the LCD display. The transmitter will not transmit when Off is displayed. Refer to the following OFFSET frequency chart (TABLE 1) before you actually transmit. The transmitting frequency may differ from the frequency that appears on the LCD display.

| LCD DISPLAY FREQUENCY | ACTUAL FREQUENCY |
|-----------------------|------------------|
| ***.*02.5 Khz         | ***.*00.0 Khz    |
| ***.*07.5 Khz         | ***.*05.0 Khz    |
| ***.*17.5 Khz         | ***.*15.0 Khz    |
| ***.*22.5 Khz         | ***.*20.0 Khz    |
| ***.*27.5 Khz         | ***.*25.0 Khz    |
| ***.*32.5 Khz         | ***.*30.0 Khz    |
| ***.*42.5 Khz         | ***.*40.0 Khz    |
| ***.*47.5 Khz         | ***.*45.0 Khz    |
| ***.*52.5 Khz         | ***.*50.0 Khz    |
| ***.*57.5 Khz         | ***.*55.0 Khz    |
| ***.*67.5 Khz         | ***.*65.0 Khz    |
| ***.*72.5 Khz         | ***.*70.0 Khz    |
| ***.*77.5 Khz         | ***.*75.0 Khz    |
| ***.*82.5 Khz         | ***.*80.0 Khz    |
| ***.*92.5 Khz         | ***.*90.0 Khz    |
| ***.*97.5 Khz         | ***.*95.0 Khz    |

TABLE 1 OFFSET FREQUENCY CHART

### 3.1.9 REV KEY

The REV key allows instant reversal of the REV function is also useful to check the repeater input to determine if another station is heard directly so you can go simplex. To activate the REV function:

1. Press and hold the FUNC key, then press the REV key. The repeater input frequency and opposite SHIFT indicator will appear on the LCD display panel.

Page 7

2. Press and hold the FUNC key, then press the REV key again to cancel the REV function.

If the REV key is pressed and a beep is heard with no change, the frequency would have been out of band and no change will take place. The beep won't be heard through the speaker if it has been turned off. See Section 9.2 for more information.

### 3.1.10 TONE KEY

The Tone Encoder and Tone (Decoder) Squelch function is standard on the DJ-580T/E. Tone Encode and Decode work on the Active Band only. The DJ-580T/E has 38 settings from 67.0 hz to 250.3 hz (TABLE 2). Utilize the TONE key to access these settings. Access to an

increasing number of repeaters is restricted by requiring that a sub-audible tone be transmitted with the input signal to open the repeater. To select the needed tone, perform the following:

1. Press and hold the FUNC key, then press the TONE key. A tone frequency will appear in the LCD display.
2. Rotate the Main Tuning dial or either the UP ARROW or DOWN ARROW key to the desired tone frequency.
3. Select the Active Band by pressing the VHF or UHF key.
4. The tone has now been selected, now you need to enable it. Press the T.SQL key.

Refer to section 9.4 for more information.

Sub-Audible Tone Chart

|       |       |       |       |       |       |
|-------|-------|-------|-------|-------|-------|
| 67.0  | 71.9  | 74.4  | 77.0  | 79.7  | 82.5  |
| 85.4  | 88.5  | 91.5  | 94.8  | 97.4  | 100.0 |
| 103.5 | 107.2 | 110.9 | 114.8 | 118.8 | 123.0 |
| 127.3 | 131.8 | 136.5 | 141.3 | 146.2 | 151.4 |
| 156.7 | 162.2 | 167.9 | 173.8 | 179.9 | 186.2 |
| 192.8 | 203.5 | 210.7 | 218.1 | 225.7 | 233.6 |
| 241.8 | 250.3 |       |       |       |       |

TABLE 2 SUB-AUDIBLE TONES

### 3.1.11 PO KEY

Change power output levels by performing the following.

1. Press and hold the FUNC key, then press the PO key repeatedly to obtain the desired output power.

When H is displayed it means that the output power is at maximum/high for battery rating. When M is displayed it means

that the output power is at mid range for battery rating. When L is displayed it means that the output power is at the lowest range for battery rating. Refer to the battery specifications for more on output levels.

Page 8

\*\*\* WARNING \*\*\*

It is possible to cause UHF receive interference while transmitting on VHF. To avoid this from happening, make sure that the VHF frequency x 3 does not equal the frequency on UHF. For example, if VHF transmit frequency is 146.190 the UHF frequency should not be set at 438.570.

### 3.1.12 T.SQL KEY

The Tone Encoder and Tone (Decoder) Squelch function is standard on

the DJ-580T/E. Tone Encode and Decode works on the Active Band only. In other words, it is expected that you can only speak on one band at a time. When changing over to the other band, another tone may be used. Further clarification is made in the cross band repeat section. The DJ-580T/E has 38 settings from 67.0 hz to 250.3 hz (TABLE 3). Utilize the TONE key to access these settings. Access to an increasing number of repeaters is restricted by requiring that a sub-audible tone be transmitted with the input signal to open the repeater. In the following examples, it is presumed that you are learning how to operate the Tone Encode/Decoder for the first time.

#### Selecting Tone Encoding

1. Press and hold the FUNC key, then press the TONE key. A tone frequency will appear in the LCD display.
2. Rotate the Main Tuning dial or either the UP ARROW or DOWN ARROW key to the desired tone frequency.
3. Select the Active Band by pressing the VHF or UHF key.
4. Press and hold the FUNC key, then press the T.SQL key. A white lettered T in a black box will appear on the top left-hand side of the LCD display. This indicator means that you have enabled subaudible tone encoding.

#### Selecting Tone Decoding

1. Press and hold the FUNC key, then press the TONE key. A tone frequency will appear in the LCD display.
2. Rotate the Main Tuning dial or either the UP ARROW or DOWN ARROW key to the desired tone frequency.
3. Select the Active Band by pressing the VHF or UHF key.
4. Press and hold the FUNC key, then press the T.SQL key. A white lettered T in a black box will appear on the top left-hand side of the LCD display. This indicator means that you have enabled subaudible tone encoding.
5. Press and hold the FUNC key, then press the T.SQL key. The letters SQL will appear to the right of the T indicator just mentioned in step 4. When T and SQL display, then tone squelch or tone decoding is enabled.

The tone frequency is now stored and will be transmitted with the repeater input frequency.

Sub-Audible Tone Chart

|       |       |       |       |       |       |
|-------|-------|-------|-------|-------|-------|
| 67.0  | 71.9  | 74.4  | 77.0  | 79.7  | 82.5  |
| 85.4  | 88.5  | 91.5  | 94.8  | 97.4  | 100.0 |
| 103.5 | 107.2 | 110.9 | 114.8 | 118.8 | 123.0 |



|       |       |       |       |       |       |
|-------|-------|-------|-------|-------|-------|
| 127.3 | 131.8 | 136.5 | 141.3 | 146.2 | 151.4 |
| 156.7 | 162.2 | 167.9 | 173.8 | 179.9 | 186.2 |
| 192.8 | 203.5 | 210.7 | 218.1 | 225.7 | 233.6 |
| 241.8 | 250.3 |       |       |       |       |

TABLE 3 SUB-AUDIBLE TONES

### 3.1.13 BEEP KEY

When the BEEP is on, each key pressed will sound a BEEP.

1. Press and hold the FUNC key, then press the BEEP key. Each time the BEEP key is pressed the speaker will emit a high or low pitch tone. If the tone is high pitch, the BEEP is disabled, if low it is enabled.

The BEEP function, when set, will be activated on both bands. The BEEP will sound only if the BEEP function is on.

The radio comes preset with a low/soft beep audio level. If you would like to increase this level to high, perform the following.

1. Press and hold the FUNC key, then press the \* key. The LCD will display FL.
2. Press and hold the FUNC key, then press the STEP key. The display will indicate bEEPH, for beep tone high level audio.
3. Press and hold the FUNC key, then press the STEP key. The display will indicate bEEPL, for beep tone low level audio.
4. Press and hold the FUNC key, then press the \* key three (3) times to clear FL/PL from the display and exit beep tone level mode.

### 3.1.14 TMS KEY

This key is used to select 1 of 3 scan modes. Refer to section 8.3 for more information.

### 3.1.15 APO KEY

The APO key is used to Automatically Power Off the radio. Using this function prevents inadvertent waste of battery power when the radio is left ON unintentionally. Here's how to use it.

1. Press and hold the FUNC key, then press the APO key. You will see APo 30 displayed.

2. The time of 30 minutes is preset from the factory. The time duration can be selected by rotating the Main Tuning Dial. The time is adjustable from 5 to 60 minutes.
3. Press and hold the FUNC key, then press the APO key. A beep

will be heard and the APO indicator will display on the LCD. If there is no activity within the time you have specified, a series of beeps will be heard, 30 seconds later the LCD will become blank. Battery power has now been removed from the radio. To re-initialize APO, turn the radio off and back on again.

4. Exit the APO function, select the Active Band by pressing the VHF or UHF key. The APO indicator should still be displayed on the LCD.
5. To cancel APO, press and hold the FUNC key, then press the APO key 2 times. The APO indication should now disappear from the display. Exit the APO function, select the Active Band by pressing the VHF or UHF key.

Any signal received during the APO time period, APO resets back to the beginning.

#### 3.1.16 DOWN ARROW AND FL/PL KEY

The DOWN ARROW toggles different values depending on what task you are utilizing. It is often used to decrease VFO frequency value. If this key is held down, the value will decrease continuously.

FL stands for Frequency Lock. In this mode the main keypad, SCN/PS and CALL/W keys are locked and don't function.

PL stands for Push To Talk Lock. In this mode both bands are locked from the Push to Talk switch. Frequencies can still be entered and stored.

These are useful features to prevent unauthorized functioning while the radio is in unattended monitoring mode. Here's how to use these features.

1. Press and hold the FUNC key, then press the FL/PL key. Each time you press the key, you will toggle the field which will be displayed as follows: FL, PL then FL and PL and finally both functions disabled.

#### 3.1.17 DUAL KEY

This function is used to monitor two particular channels. The possibilities are:

- o VFO and MEMORY channels
- o VFO and CALL channels
- o VFO and VFO channels
- o CALL and MEMORY channels

In other words, dual channel monitoring will listen to two channels. Here's how to make it happen for VFO and MEMORY. You can

incorporate the same procedure with the other possibilities of DUAL WATCH.

1. Select the Active Band by pressing the VHF or UHF key.
2. Press the MR key. Select the desired memory channel by using the Main Tuning Dial.

The 2 digit memory channel number will blink if it hasn't been programmed. More on memory channel programming can be found in section 6.2.

3. Return to VFO Mode and enter a VFO frequency.
4. Press and hold the FUNC key, then press the DUAL key. The PRI indicator will now blink on and off on the display. The radio will cycle alternately between VFO frequency and Memory frequency for 1/2 second.
5. When a signal is received, the signal is held for 5 seconds.
6. To release the DUAL/WATCH function, press the PRI or chosen VFO key.

#### 3.1.18 UP ARROW AND MESS KEY

The UP ARROW toggles different values depending on what task you are utilizing. It is often used to increase VFO frequency value. If this key is held down, the value will increase continuously.

The MESS key is used for Digital Signal messages. Refer to section 11.7.

#### 3.1.19 PRI/DIAL M KEY

PRI stands for Priority. When the PRI key is pressed the priority function is active.

The DIAL M key is used for storing and automatically transmit a sequence of numbers/codes. This would be commonly used for autopatch use. Refer to section 10 for more information.

#### 3.1.20 GP DSQ/DSQS KEY

This key is used in conjunction with DTMF squelch control. More information can be found in section 11.

#### 3.1.21 SKIP/M TO V KEY

The SKIP key is used to skip selected memory channels during a memory scan.

The M to V function of this key is used to copy information from a memory location into the VFO.

### 3.1.22 MR/MW KEY

MR stands for Memory Read. This function is used to examine what information is in a memory channel.

MW stands for Memory Write. This function is used to write/store frequencies and features into a memory channel. Refer to section 6.2 on for more information.

1. Press the MR key to put the Active Band into Memory Channel mode. A 2 digit memory channel number (0-19) will appear. These 2 digits will flash if nothing has been programmed into the memory channel.
2. Pressing the SCN key will increment each programmed memory channel one at a time. Use the Main Tuning Dial to either increment or decrement scanning.

### 3.1.23 SCN/PS KEY

The SCN key is used to continually scan frequencies in VFO or memory mode. Press the key down for approximately one second and scan will begin. Scan is active by virtue of the flashing decimal point, just right of the 1 megahertz digit. To cease scan, press the SCN key once again.

PS stands for Programmable Scan. This is used when you want to scan a range of frequencies. You may scan a range of frequencies on VHF and perform the same for UHF at the same time. Here is how it works.

1. Select the Active Band by pressing the VHF or UHF key.
2. Now enter the lower range frequency via the keypad.
3. Press the MR key. Rotate the Main Tuning Dial and select memory channel P1.
4. Press and hold the FUNC key, then press the MW key. A beep will sound from the speaker and memory channel P1 will stop blinking. P1 has been successfully programmed with the lower frequency.
5. Now enter the higher range frequency via the keypad.
6. Press the MR key. Rotate the Main Tuning Dial and select memory channel P2.
7. Press and hold the FUNC key, then press the MW key. A beep will sound from the speaker and memory channel P2 will stop blinking. P2 has been successfully programmed with the upper frequency.
8. Select the Active VFO band as you did in step 1.

9. Press and hold the FUNC key, then press the PS key. The display will show scanning of ranges programmed between P1 and P2. The P indicator should begin to blink on the LCD display.
10. Exit programmable scan, select the Active Band by pressing the VHF or UHF key or SCN key.

If you are scanning (SCN) or manually tuning, consider the following.

- o When passing a 500KHz boundary, a single beep will be heard through the speaker.
- o When incrementing frequencies past a 1MHz boundary, a low beep followed by a high beep will be heard through the speaker.
- o When decrementing frequencies past a 1MHz boundary, a high beep followed by a low beep will be heard through the speaker.
- o The Battery Saver feature will not function when in the SCN function, even though the BS indicator is displayed on the LCD.

#### 3.1.24 CALL/CALL.W KEY

Each band has 1 Call channel which is immediately accessible by pressing the CALL key. An often used frequency of interest such as a preferred local repeater, is usually programmed into the Call channel.

The CALL key is used to gain access to the CALL channel.

The CALL.W key is used to write information into the CALL channel.

Refer to section 6.3 for more information.

#### 3.1.25 LAMP KEY

The lamp key allows you to read the display at night, or those areas where it is difficult to read the LCD display.

1. Press the LAMP key to illuminate the LCD display. The lamp goes out automatically after five seconds.
2. If you wish for the lamp to remain on, press and hold the FUNC key, then press the LAMP key.

#### 3.1.26 MONI/BS KEY

MONI is short for the word MONITOR or SQUELCH OPEN. Activate this feature as follows:

1. Press and hold the MONI key to override the squelch on the band selected. In this mode, weak signals below the squelch threshold may be heard.

Page 14

BS is short for Battery Saver. The battery saver feature reduces unnecessary battery drain by alternating between listening and the Battery Saver mode. If there is no operation for a period of 5 seconds the BS mode will listen for a signal for approximately 130 ms then Battery Save for approximately 390 ms. This cycle is repeated continuously. Perform the following to activate or deactivate Battery Save feature. You can set this function in VHF or UHF or both bands together.

1. To activate battery save feature, press and hold the FUNC key, then press the BS key until the symbol S is displayed.
2. To deactivate battery save feature, press and hold the FUNC key, then press the BS key until the S disappears.

\*\*\* NOTE \*\*\*

Battery Saver is not active during SCN function, even though the S indicator is displayed on the LCD.

### 3.2 TOP PANEL CONTROLS/FUNCTIONS

The following section describes the controls that are located on the top panel.

#### 3.2.1 BNC ANTENNA CONNECTOR

You should attach a suitable Dual-Band antenna that will yield a low SWR. The antenna connected should satisfy both the 2 meter and 70 cm (440MHz) band.

#### 3.2.2 VHF VOLUME CONTROL

Adjusts the VHF audio level. Rotate control clockwise to increase volume , and counter clockwise to decrease.

#### 3.2.3 VHF SQUELCH

Start by turning the knob fully counter clockwise, then rotate the knob back clockwise until background noise is silent.

#### 3.2.4 POWER ON/OFF AND UHF VOLUME CONTROL

Power is not applied to the radio when the POWER knob is fully counter clockwise. When the POWER knob is rotated clockwise, power is applied to the radio and volume for the UHF band may be adjusted.

#### 3.2.5 UHF SQUELCH

Start by turning the knob fully counter clockwise, then rotate the knob back clockwise until background noise is silent.

### 3.2.6 MAIN TUNING DIAL

Press the VHF or UHF key to select the Active Band. The Main Tuning dial may be rotated in either direction to select transmit and

Page 15

receive frequencies, frequency steps, subaudible tones and transmit frequency offsets. The frequency will increase/decrease by one MHz depending on the direction of the tuning dial rotation.

### 3.2.7 SPEAKER JACK

An external speaker rated at 8 ohms may be plugged into this jack. The built-in speaker is disabled when an external speaker is plugged into this jack.

If you decide to use the V.U.SP jack while using the SPeaker jack, the VHF audio will not be heard. The VHF audio is routed through the V.U.SP jack.

### 3.2.8 MIC JACK

An external microphone may be plugged into this jack.

### 3.2.9 V.U.SPEAKER JACK

The DJ-580T/E features an external 1/8" stereo jack that makes accessible the audio supplied from each band (UHF/VHF). When a stereo headset is used, each band is heard separately, in each earphone. Separate external speakers may be plugged into this jack by using a mini dual stereo adapter plug. Volume from the VHF band will be heard on the left channel and UHF will be heard on the right channel. It is advisable to use the SPeaker jack when using a mono plug.

\*\*\* NOTE \*\*\*

When this jack is in use, the speaker jack located on the top of the radio will be disabled.

If you decide to use the V.U.SP jack while using the SPeaker jack, the VHF audio will not be heard. The VHF audio is routed through the V.U.SP jack.

## 3.3 LEFT SIDE CONTROLS/FUNCTIONS

The following controls are located on the left side of the radio as viewed with front panel facing the operator.

### 3.3.1 FUNCTION KEY

Controls access to secondary functions. These secondary functions are those functions printed in green on the front panel. It is necessary to activate the function key to access these secondary

functions. While holding the FUNC key, press the desired command key.

### 3.3.2 PTT SWITCH

Press and hold this button to transmit. While holding the PTT SWITCH you may speak into the microphone.

Page 16

\*\*\* NOTE \*\*\*

On the DJ-580E the lower portion of the PTT SWITCH is used to transmit Tone Burst, and the upper portion is the PTT SWITCH. On the DJ-580T either button activates PTT SWITCH.

### 3.3.3 BATTERY LOCK BUTTON

The battery lock button releases the battery from the radio. The battery is keyed in order to avoid the battery from being inserted incorrectly. To attach the battery, slide battery in guides from left to right until the lock snaps battery into place. To remove battery, push and hold the lock button upwards and slide the battery to the left (from vantage point where radio front panel is facing you).

## 3.4 RIGHT SIDE CONTROLS/FUNCTIONS

The following controls are located on the right side of the radio as viewed with front panel facing the operator.

### 3.4.1 DC IN JACK

Utilizing this jack will provide maximum output power. Plug an external 13.8 VDC power source into this jack.

\*\*\* CAUTION \*\*\*

Observe correct plug polarity. The tip of the connector is (+) and the sleeve is (-).

When a voltage source is applied to this jack the battery is cutoff and no charging to the battery will take place.

The EDC-36 or EDC-37 is recommended as optional accessories. Refer to section 1.2 for additional information on OPTIONAL ACCESSORIES.

## 3.5 LCD DISPLAY DESCRIPTIONS

The following subsections discuss those indicators viewed on the LCD display.



#### 3.5.1 MEMORY CHANNEL

This 2 digit indicator shows that the selected band is in memory mode and displays the memory channel number.

#### 3.5.2 BATTERY SAVE

The symbol S appears while battery save function is activated.

#### 3.5.3 TONE ENCODER/TONE SQUELCH

The symbol T appears when tone encoder is active and TSQL when tone squelch (Decode) function is activated.

Page 17

#### 3.5.4 PRIORITY/DUAL WATCH

The symbol PRI appears when PRIORITY/DUAL WATCH function are activated.

#### 3.5.5 AM

This symbol will appear when the aircraft modification has been performed. The symbol AM indicates that the AM detector is active. Refer to Section 14 for information on the aircraft modification.

#### 3.5.6 SPLIT

The star symbol appears when the split function is activated.

#### 3.5.7 TIMER SCAN

This T symbol appears above the (frequency) 10KHz digit. When the T symbol disappears, BUSY SCAN is activated. When the T symbol is present, TIMER SCAN is activated. The radio defaults to BUSY SCAN.

#### 3.5.8 OUTPUT POWER

When the symbol L is displayed, LOW power is active. The indicator M is for MID power and H for HIGH power.

#### 3.5.9 DIALER

When the telephone symbol appears, the DIALER MEMORY is activated.

#### 3.5.10 SHIFT

The symbols +, - or star are used by the shift function.

#### 3.5.11 DSQ

When P or G and DSQ are displayed, DSQ functions are enabled. DSQ stands for DTMF squelch control.

#### 3.5.12 VHF

The VHF symbol indicates that the VHF band has been selected.

#### 3.5.13 FREQUENCY INDICATOR

Receive and transmit frequencies, offset and tone frequencies, channel steps, DSQ codes and dialer memory channel numbers are displayed in this area depending on the selected mode.

#### 3.5.14 AUTO POWER OFF (APO)

APO appears when AUTO POWER OFF is activated.

#### 3.5.15 ON AIR

The symbol ON AIR appears when transmitting.

Page 18

#### 3.5.16 S/RF

In receive mode the S/RF symbol and Signal/RF bars will be displayed to show signal strength. When transmitting occurs, the ON AIR symbol and Signal/RF bars indicate RF output power.

#### 3.5.17 FREQUENCY DECIMAL POINT

When receive, transmit or offset frequencies are displayed on the LCD, the decimal point divides MHz and KHz.

#### 3.5.18 TONE FREQUENCY DECIMAL POINT

When the Tone frequency is displayed, the decimal point divides Hz and 0.1 Hz.

\*\*\* NOTE \*\*\*

This decimal point is also used to indicate that the PLL circuitry isn't locking in on the frequency entered. In other words, you are unlikely to receive the frequency that you have entered when this decimal point is blinking within the frequency displayed on the LCD.

#### 3.5.19 PL (PTT LOCK)

The PL symbol indicates that the PTT switch is locked. The radio will not transmit even if the PTT switch is pressed accidentally.

#### 3.5.20 FL (FREQUENCY LOCK)

FL stands for FREQUENCY LOCK. When FL is displayed, the command and control function keys are locked out. Utilizing this function prevents accidental use of command and control pad keys.

#### 3.5.21 UHF

This symbol indicates that the UHF band has been selected.

## GETTING STARTED (RECEIVING)

1. Adjust the following switches and controls on the top of the radio.
  - o POWER/UHF KNOB: OFF
  - o VOLUME CONTROLS: Fully Counter Clockwise
  - o SQUELCH CONTROLS: Fully Counter Clockwise
2. Connect a battery or external 13.8 Volt DC Power Supply to the radio.
3. Connect a dual band antenna with the appropriate antenna connector to the top of the radio. The type of antenna fitting that is expected is a BNC type.
4. Rotate the POWER knob clockwise until power is applied to the radio.

Page 19

5. Rotate the VHF volume control (left knob) and the UHF volume control (center knob) clockwise until a signal (or noise) is heard through the speaker. The display should be illuminated and indicate frequencies for both bands. The initial factory delivered settings for VHF are found in Table 4, UHF in Table 5.

## VHF

|                     |             |                     |             |
|---------------------|-------------|---------------------|-------------|
| VFO Frequency:      | 145.000 MHz | DSQ Setting:        | None        |
| Memory Frequency:   | Empty       | Call Frequency:     | 145.000 MHz |
| Channel Step(580T): | 5 KHz       | Tone Setting:       | None        |
| Channel Step(580E): | 12.5 KHz    | Tone Frequency:     | 88.5        |
| Shift:              | None        | Transmitter Output: | Mid         |
| Offset Frequency:   | 0.6 MHz     | Call Freq.(580T):   | 145.000 MHz |
| Memory Channel:     | 1           | Call Freq.(580E):   | 145.000 MHz |

TABLE 4 VHF DEFAULT SETTINGS

## UHF

|                     |             |                     |             |
|---------------------|-------------|---------------------|-------------|
| VFO Freq. 580T:     | 445.000 MHz | DSQ Setting:        | None        |
| VFO Freq. 580E:     | 433.000 MHz | Call Freq.(580T):   | 445.000 MHz |
| Memory Channel:     | 1           | Call Freq.(580E):   | 433.000 MHz |
| Channel Step(580T): | 5 KHz       | Offset Freq.(580T): | 5 MHz       |
| Channel Step(580E): | 12.5 KHz    | Offset Freq.(580E): | 7.6 MHz     |
| Shift:              | None        | Tone Frequency:     | 88.5 Hz     |
| Tone Setting:       | None        | Transmitter Output: | Mid         |

TABLE 5 UHF DEFAULT SETTINGS

6. Rotate the Main Tuning dial, and select an open frequency on each band. Rotate the squelch control clockwise for each band until the S/RF indicator disappears from each band on the LCD display.

7. Select the desired band by pressing the VHF or UHF buttons. The VHF symbol will display on the LCD when VHF is enabled. The UHF symbol will display on the LCD when UHF is enabled.

\*\*\* NOTE \*\*\*

When the external power source is connected, make sure you power off the radio before turning off the power supply.

#### 4.1 KEY PAD DIRECT ENTRY

When frequency is selected by key pad direct entry, numbers will appear on the LCD display as they are entered on the key pad.

To enter frequency directly from the key pad, try the following. The following example will use the two meter frequency 146.52.

1. Select the Active Band by pressing the VHF or UHF key.
2. Enter the 100MHz digit first. Example: 1--.---

Page 20

3. Enter the 10MHz digit next. Example: 14-.---
4. Enter the 1MHz digit next. Example: 146.---
5. Enter the 100KHz digit next. Example: 146.5--
6. Enter the 10KHz digit next. Example: 146.52-
7. Enter the 1KHz digit last. Example: 146.520

If radio STEP is greater than 10KHz, the 10KHz digit will be the last digit to enter followed by a higher pitch beep. The band indicator will stop flashing.

If radio STEP is selected for 5KHz, enter the last digit.

#### 4.2 STEP KEY

The STEP function is used to select desired incremental changes of receive/transmit frequencies, in steps of 5, 10, 12.5, 15, 20 or 25KHz. Use this feature as follows:

1. Select the Active Band by pressing the VHF or UHF key.
2. Press and hold the FUNC key, then press the STEP key. Change the channel step by using the Main Tuning dial, A/UP ARROW or B/DOWN ARROW keys.
3. Select the Active Band by pressing the VHF or UHF key to set channel step and return to operating frequency.
4. After channel step is set, the receive/transmit frequency will

increase or decrease by the value selected when you turn the Main Tuning dial.

\*\*\* NOTE \*\*\*

The following rules apply to channel steps as indicated.

When 5 KHz channel step is selected, keys 0 and 5 are available for entry into the 1KHz digit.

When 10 KHz channel step is selected, keys 0, 1, 2, 3, 4, 5, 6, 7, 8 and 9 are available for entry into the 10KHz digit.

When 12.5 KHz channel step is selected, keys 0, 1, 2, 3, 5, 6, 7 and 8 are available for entry into the 10KHz digit.

When 15 KHz channel step is selected, keys 0, 1, 3, 4, 6, 7 and 9 are available for entry into the 10KHz digit.

When 20 KHz channel step is selected, keys 0, 2, 4, 6, and 8 are available for entry into the 10KHz digit.

When 25 KHz channel step is selected, keys 0, 2, 5 and 7 are available for entry into the 10KHz digit.

Page 21

#### 4.3 CLEARING ENTRY

To clear an error during key pad entry, you may:

- o Press the VHF or UHF band key, or
- o Press the PTT key.

#### 4.4 MONO BAND FUNCTION

If you only want to use one band without distraction from the other band, follow these steps for mono band.

1. Power off the radio.
2. Press either the VHF or UHF key while powering on the radio.

Restore dual band capability by pressing the inactive band key. If VHF is selected for mono band operation, press the UHF key to restore dual band operation.

#### 5 TRANSMITTING

1. Make sure that you follow all steps set forth in the "GETTING READY" section (Section 4) first.
2. Select a frequency, shift direction, shift value, and sub-audible tone frequency.
3. Check to see if the frequency is in use before transmitting.

4. Select appropriate transmitter output level.

5. Press the PTT switch and speak approximately 5" from the microphone, located on the front of the radio.

#### 5.1 POWER OUTPUT SETTING

There are three power settings on the DJ-580T/E. You may select either High (H), Medium (M) or Low (L) from the PO function on the front panel. Refer to the battery specifications for more on output levels.

Change power output levels by performing the following.

1. Press and hold the FUNC key, then press the PO key repeatedly to obtain the desired output power.

\*\*\* WARNING \*\*\*

It is possible to cause UHF receive interference while transmitting on VHF. To avoid this from happening, make sure that the VHF frequency x 3 does not equal the frequency on UHF. For example, if VHF transmit frequency is 146.190 the UHF frequency should not be set at 438.570.

Page 22

#### 5.2 LOW LEVEL BATTERY MODE

This function allows for extended use due to power drop in battery. The FULL indicator will begin to flash when battery drops to approximately 6.2 volts. When you operate your squelch just on the threshold, it will begin to open at approximately 4.75 volts. The sensitivity and transmit power will begin to drop at this time compared to normal operation. The radio will continue to operate until approximately 4.50 volts. At this point in time the battery should be charged.

#### 6 TRANSCIVER MODES

The DJ-580T/E has 3 modes; VFO mode, Memory mode and Call mode.

##### 6.1 VFO MODE (Variable Frequency Oscillator)

The transceiver will be in VFO mode. This mode is used to change frequency and select the desired channel step, offset frequency (up to 10.995 MHz by 5 KHz), tone frequency (38 frequencies in Hz), Dual Watch, etc.

1. Select the Active Band by pressing the VHF or UHF key.

##### 6.2 MEMORY MODE

The following guidelines will help you to program and manipulate memory channels. In memory mode, memory channels can be reviewed. Other features include Memory Scan, Memory Priority and Dual Watch. To select the memory mode, press the MR key. The memory used last will display:

- o Frequency
- o Memory channel number
- o Other programmed functions

#### 6.2.1 PROGRAMMING A MEMORY CHANNEL (MW KEY)

To write functions to any memory channel, it is necessary to first set those functions in the VFO mode.

- o Select VFO mode (VHF or UHF band key).
- o Select the receive frequency.
- o Select the repeater shift - or + or split
- o Select the required offset. Consult your Repeater Directory.
- o Select the proper CTCSS subaudible tone "T". Consult your Repeater Directory.
- o Select Tone Squelch (Decoder) "T SQL".
- o Select Tone Frequency

After selecting and setting the required functions you can write (store) those functions to a memory channel as follows:

1. Select the Active Band by pressing the VHF or UHF key.
2. Select a frequency, shift direction, shift value, CTCSS subaudible tone, Tone squelch and Tone frequency.

Page 23

3. Press the MR key. A two-digit memory channel number will be displayed on the LCD. If these digits are flashing, it means that this channel number has no information stored.
4. Rotate the Main Tuning Dial clockwise to choose the desired memory channel number (clockwise to increase, counter clockwise to decrease). Select the desired memory channel number (0 to 19).
5. Press and hold the FUNC key along with the MW key to write (store) frequency to memory.
6. Press the MR key to exit.

An alternate method for programming the memory channel is provided as follows:

1. Select the Active Band by pressing the VHF or UHF key.
2. Press the MR key. A two-digit memory channel number will be displayed on the LCD. If these digits are flashing, it means that this channel number has no information stored.

3. Turn the Main Tuning Dial clockwise to choose the desired memory channel number (clockwise to increase, counter clockwise to decrease). Select the desired memory channel number (0 to 19).
4. Select a frequency, shift direction, shift value, CTCSS subaudible tone, Tone squelch and Tone frequency.
5. Press and hold the FUNC key along with the MW key to write (store) to memory.
6. Press the MR key to exit.

#### 6.2.2 SCROLL MEMORY

Scrolling the VHF or UHF bank of memory channels up or down can be accomplished 1 of 2 ways.

##### MR KEY

1. Press the MR key to put the Active Band into Memory Channel mode. The memory channel number (0-19) will appear. A flashing channel number indicates that no information has been programmed into this memory channel. Turn the Main Tuning dial to increment and decrement the memory channel or use the UP ARROW/DOWN ARROW keys.
2. Press the MR key to exit MEMORY MODE and return to VFO MODE. The two digit memory channel will disappear from the LCD display showing that you have returned to VFO MODE.

#### Page 24

You can scan the memory channels with the SCN key, elect to skip any memory channel with the SKIP key, or select the scan type with the TMS key. Refer to the section SCANNING FUNCTIONS (Section 8) for more information.

The DJ-580T/E has two (02) banks of memory channels:

First, the VHF bank has 20 memory channels that are accessed with the MR key.

Secondly, the UHF bank has 20 memory channels that are accessed with the MR key.

#### 6.2.3 CANCELING A MEMORY CHANNEL

1. Select the Active Band by pressing the VHF or UHF key.
2. Press the MR key.
3. Rotate the Main Tuning Dial to choose the desired memory



channel number (clockwise to increase, counter clockwise to decrease). Select a non-flashing memory channel number.

The number of memory channels will change if you have utilized the ALLOCATION OF MEMORY CHANNELS feature. The radio defaults it's memory channels from 0 to 19 on VHF and 0 to 19 on UHF.

4. Press and hold the FUNC key, then press the MW key to cancel this memory channel. The two digit memory channel number will now begin to flash indicating that the content of this memory channel has been cleared.

#### 6.2.4 ALLOCATION OF MEMORY CHANNELS

Using this feature will allow you to free up memory channels from either band and allocate to the other band for frequency storage.

##### EXAMPLE: ALLOCATE MEMORY CHANNELS

Lets say you wish that you had 25 programmable VHF memory channels but the radio comes defaulted to 20. No problem, that's why this feature has been included. Since the radio has 40 channels in total, 20 for each VFO, it is possible to allocate all 40 channels to one band for memory programming. This scenario would leave the other band with no programmable memory channels. Here is how to make it all happen.

1. Press and hold the FUNC key, then press the \* key. The symbol FL will appear on the LCD display.
2. Press and hold the FUNC key, then press the 1 key. The number of allocated memory channels for each VFO will appear on each band display.

When the Main Tuning Dial is rotated clockwise, the number of possible VHF memory channels will increase. This number will increase while the allocated memory channels from the UHF side will decrease.

Page 25

When the Main Tuning Dial is rotated counter clockwise, the number of possible UHF memory channels will increase. This number will increase while the allocated memory channels from the VHF side will decrease.

3. Press and hold the FUNC key, then press the \* key four (4) times to clear FL/PL from the display and exit beep tone level mode.

#### 6.2.5 MEMORY TO VFO COPY FUNCTION

This function is used to copy details of a memory or call channel into a VFO.

1. Select the Active Band by pressing the VHF or UHF key.
2. Press the MR key.

3. Select a memory channel number by rotating the Main Tuning dial.
4. Press and hold the FUNC key, then press the C key. The information from the memory channel has been copied to the VFO, currently displayed.

### 6.3 CALL MODE

The CALL mode allows a single key to use an immediately desired programmed frequency. Each band has one Call Channel which can be accessed by pressing the CALL key. A preferred local repeater is usually programmed into the Call Channel. The indicator C appears on the LCD when Call Priority and/or Dual Watch function is active.

#### 6.3.1 PROGRAMMING THE CALL CHANNEL (W KEY)

To write functions to a CALL Channel, it is necessary to first set those functions in the VFO mode.

- o Select VFO mode (VHF or UHF band).
- o Select the receive frequency.
- o Select the repeater shift - or +
- o Select the required offset. Consult your Repeater Directory.
- o Select the proper CTCSS subaudible tone "T". Consult your Repeater Directory.
- o Select Tone Squelch (Decoder) "T SQL".
- o Select Tone Frequency

After selecting and setting the required functions you can write (store) those functions into a CALL Channel as follows:

1. Select the Active Band by pressing the VHF or UHF key.
2. Select a frequency, shift direction, shift value, CTCSS subaudible tone, Tone squelch and Tone frequency.

Page 26

3. Press and hold the FUNC key, then press the CALL key. The frequency selected in step 2 will be stored into the CALL channel. The C indicator appears on the LCD showing you that your current mode is CALL channel mode.
4. Press the CALL key again to return to previous mode and frequency.

#### 6.3.2 ACTIVATING CALL CHANNEL

1. Select the Active Band by pressing the VHF or UHF key.
2. Press the CALL key. The CALL indicator C will appear on the LCD display.

3. Press the CALL key again to return to previous mode and frequency.

### 6.3.3 CALL CHANNEL TO VFO COPY FUNCTION

This function is used to copy details of a memory or call channel into a VFO.

1. Select the Active Band by pressing the VHF or UHF key.
2. Press the CALL key.
3. Press and hold the FUNC key, then press the C key. The information from the call channel has been copied to the VFO, currently displayed.

## 7 PRIORITY FUNCTIONS

The following priority functions are available:

- o VFO Priority
- o Memory Priority
- o Call Priority (Dual Watch)

### 7.1 VFO PRIORITY

In this mode a VFO frequency is received for 4 seconds and a Memory frequency is received for 1/2 a second. This cycle will repeat continuously. Here is how it works:

1. Select the Active Band by pressing the VHF or UHF key.
2. Select and enter a frequency.
3. Press the MR key to activate Memory mode. If the memory channel is blinking, it hasn't been programmed.
4. Rotate the Main Tuning Dial to a desired Memory Channel that has been programmed. You may also use the UP ARROW or DOWN ARROW key to change memory channels.

Page 27

5. Return to the Active Band VFO as you selected in step 1.
6. Press the PRI key to begin priority function. The LCD will display PRI.
7. Press the PRI key to stop the priority function. The LCD will remove the flashing PRI from the display.

\*\*\* NOTE \*\*\*

When a signal is received on the memory channel a BEEP will be

emitted once from the speaker.

In VFO priority, the transmitter may be activated on either frequency. Press the PTT switch when the desired frequency is displayed on the LCD.

## 7.2 MEMORY PRIORITY

In this mode a Memory frequency is received for 5 seconds and a VFO frequency is received for 2 second in a continuous cycle. Here is how it works:

1. Select the Active Band by pressing the VHF or UHF key.
2. Select and enter a frequency.
3. Press the MR key to activate Memory mode. If the memory channel is blinking, it hasn't been programmed.
4. Rotate the Main Tuning Dial to a desired Memory Channel that has been programmed. You may also use the up or DOWN ARROW to change memory channels.
5. Press the PRI key to begin priority function. The LCD will display PRI.
6. Press the PRI key to stop the priority function. The LCD will remove PRI from the display.

\*\*\* NOTE \*\*\*

When a signal is received on the VFO frequency a BEEP will be emitted once from the speaker.

In memory priority, the transmitter may be activated on either frequency. Press the PTT switch when the desired frequency is displayed on the LCD.

## 7.3 CALL PRIORITY

The VFO frequency or Memory channel is scanned for approximately 1/2 second and the programmed CALL frequency is scanned for approximately 4 seconds.

1. Select the Active Band by pressing the VHF or UHF key.

Page 28

2. If the CALL channel hasn't been programmed yet, refer to section 6.3.1 for more information.
3. Enter a frequency into the VFO or select a Memory channel in memory channel mode.
4. Press the CALL key for approximately 1/2 second. Call priority will begin to cycle between the CALL channel and the selected

VFO or memory channel.

5. Press the PRI key to begin priority function. The LCD will display PRI.
6. Press the PRI key to stop the priority function. The LCD will remove PRI from the display.

\*\*\* NOTE \*\*\*

When a signal is received on the VFO frequency a BEEP will be emitted once from the speaker.

In CALL priority, the transmitter may be activated on either frequency. Press the PTT switch when the desired frequency is displayed on the LCD.

#### 7.4 DUAL WATCH FUNCTION

Unlike priority, there is no period for listening between two modes. Dual Watch is a constant monitoring of two modes.

##### 7.4.1 VFO/MEMORY DUAL WATCH

Perform the following for VFO/MEMORY DUAL WATCH.

1. Select the Active Band by pressing the VHF or UHF key. Enter a desired frequency.
2. Press the MR key and select the desired memory channel.
3. Return to the VFO mode as selected in step #1.
4. Press and hold the FUNC key, then press the DUAL key. The radio will begin with the VFO frequency followed by the memory channel frequency. The cycling between these frequencies is approximately .5 second.
5. Press the VFO button as selected in step #1 to stop DUAL WATCH.

\*\*\* OPERATING HINT \*\*\*

Without stopping DUAL WATCH operation, you can enter a new frequency into the selected VFO and DUAL WATCH will continue automatically. Enter the new VFO frequency via the key pad. DUAL WATCH operation will be suspended while you are entering the new VFO frequency, but will resume operation after you have completed entry.

Page 29

##### 7.4.2 CALL/VFO DUAL WATCH

Unlike priority, there is no time period for listening between two modes. Dual Watch is a constant monitoring of two modes. Perform the following for CALL/VFO DUAL WATCH.

1. Select the Active Band by pressing the VHF or UHF key. Enter a desired frequency.
2. Press the CALL key. The CALL channel must be programmed.
3. Press and hold the FUNC key, then press the DUAL key. The radio will begin with the CALL frequency followed by the VFO frequency. The cycling between these frequencies is approximately .5 second.
4. Press the Active Band key as performed in step 1 to stop DUAL WATCH.

#### 7.4.3 CALL/MEMORY DUAL WATCH

Unlike priority, there is no time period for listening between two modes. Dual Watch is a constant monitoring of two modes. Perform the following for CALL/MEMORY DUAL WATCH.

1. Press the MR key and select the desired memory channel.
2. Press the CALL key. The CALL channel must be programmed.
3. Press and hold the FUNC key, then press the DUAL key. The radio will begin with the CALL frequency followed by the memory channel frequency. The cycling between these frequencies is approximately .5 second.
4. Press the VFO button as selected in step #1 to stop DUAL WATCH.

## 8 SCANNING FUNCTIONS

The DJ-580T/E offers various scanning options and 3 scanning modes described a little later on in this section. First lets look at the scanning options, they are:

- |                              |                                                                                     |
|------------------------------|-------------------------------------------------------------------------------------|
| VFO Scan                     | - Scans either band independently.                                                  |
| Program Band Scan (VFO Mode) | - Scans programmed lower to upper frequencies. You may scan a range of frequencies. |
| Memory Scan                  | - Each band may scan memory channels independently.                                 |

Whether you are scanning (SCN) or manually tuning, when;

- o Passing a 500KHz boundary a single beep will be heard through the speaker.

- o Incrementing frequencies past a 1MHz boundary, a low beep followed by a high beep will be heard.

- o Decrementing frequencies past a 1MHz boundary, a high beep followed by a low beep will be heard.

## 8.1 VFO SCAN

Each band may scan VFO channels independently. When in Band Scan mode the DJ-580T/E scans by channel Step. Refer to Section 3.1.7 for more information on the channel Step key. As the scan passes through any 500 KHz or 1 MHz point a tone will sound if the BEEP function is active.

1. Select the Active Band by pressing the VHF or UHF key twice. The purpose for pressing the band key twice is in the event you are in memory mode by mistake.
2. Press the SCN key for approximately 1 second, a beep will be heard. Release the SCN key. Use the Main Tuning dial or UP ARROW or DOWN ARROW keys to scan in a particular direction.
3. Whether you are cycling upward or downward, during scan the decimal point will flash indicating that scanning has begun.
4. When a signal is received, scanning will stop and remain on that frequency. When channel goes quiet or Main Tuning Dial is rotated clockwise or counter clockwise, scanning will continue.
5. To cancel scanning press the SCN key. A beep will not be heard when initially pressed, but will be heard when the SCN key is released.

All 3 scan types can be applied to Band Scan.

### 8.1.1 PROGRAM BAND SCAN MODE (VFO MODE)

This scan option allows the scanning of a range of VFO frequencies. Each band may have independent scan ranges. The lower band limit is programmed into Memory Channel P1. The upper band limit is programmed into Memory Channel P2. You may initiate Program Band Scan from either VFO or Memory mode.

#### EXAMPLE: STORING LOWER/UPPER RANGES

1. Select the Active Band by pressing the VHF or UHF key, for example VHF.
2. Enter a desired Lower Frequency via the key pad, for example "146.000".
3. Press the MR key.
4. Rotate the Main Tuning Dial until P1 is displayed.

5. Press and hold the FUNC key, then press the MW key to store the selected Lower Frequency into memory.
6. Enter a desired Upper Frequency via the key pad like 146.100.
7. Press the MR key.
8. Rotate the Main Tuning Dial until P2 is displayed.
9. Press and hold the FUNC key, then press the MW key to store the selected Upper Frequency into memory.
10. Press and hold the FUNC key, then press the SCN key. The letter P will begin to blink on the display. Scanning from 146.000 to 146.100 has begun.
11. Press the Active Band key as performed in step 1 to stop this function. Pressing the SCN key will also cease this function.

\*\*\* NOTE \*\*\*

The upper limit frequency and Lower limit frequency may be stored into either P1 or P2.

## 8.2 MEMORY SCAN MODE

This scan option allows the user to scan frequencies that have been programmed in any (or all) of the memory channels. Bands may be scanned individually or both bands may be scanned simultaneously.

1. Select the Active Band by pressing the VHF or UHF key twice. The purpose for pressing the band key twice is in the event you are in memory mode by mistake.
2. Press the MR key.
3. Press the SCN key for approximately 1 second, a beep will be heard. Release the SCN key. Use the Main Tuning dial or UP ARROW or DOWN ARROW keys to scan in a particular direction.
4. Whether you are cycling upward or downward, during scan the decimal point will flash indicating that scanning has begun.
5. When a signal is received, scanning will stop and remain on that frequency. When channel goes quiet or Main Tuning dial is rotated clockwise or counter clockwise, scanning will continue.
6. Press the Active Band as performed in step 1 to stop this function. To cancel scanning press the SCN key. A beep will not be heard when initially pressed, but will be heard when the SCN key is released.



### 8.2.1 MEMORY CHANNEL SKIP MODE

Memory Channel Skip permits unwanted memory channels to be skipped during memory scan. This step presumes that you have already programmed some/all memory channels.

1. Press the MR key.
2. Rotate the Main Tuning Dial until the memory channel that you want to skip is displayed.
3. Press the SKIP key. The decimal point will disappear from the frequency displayed, indicating this frequency will be skipped. Perform step 2 and 3 for each memory channel that you wish to skip.
4. To cancel Memory Channel Skip, press the SKIP key again. The decimal point will re-appear, and that memory channel will now be restored to scan status.

### 8.3 SCANNING TYPES

The DJ-580T/E offers 3 different scanning modes as shown below. The initial factory setting is the Busy Channel Scan.

Busy Scan - Stops at a busy channel or frequency until clear. Two seconds after the signal ceases, scanning resumes.

Timed Scan - Stops at busy channel or frequency, then resumes scan 5 seconds later even if the channel remains busy. Scanning will also resume when a signal received ceases.

Selecting a Scan Type:

1. Select the Active Band by pressing the VHF or UHF key.
2. Press and hold the FUNC key, then press the TMS key. A black block with a white lettered T will appear, indicating to you that "Timed Scan" has been selected.
3. Press and hold the FUNC key, then press the TMS key again to leave "Timed Scan". The black block with a white lettered T will disappear from the LCD display.

The DJ-580 will be in "Busy Scan" when not in "Timed Scan".

### 8.4 OTHER SCANNING INFORMATION

This subsection talks about all other information pertinent to radio scan.

#### 8.4.1 DUAL BAND SCAN

You may want to scan both bands at the same time. You can perform that function by following this example.

Page 33

EXAMPLE: DUAL BAND SCAN

1. Press the VHF key.
2. Press the UP ARROW key for approx. 1 second.
3. Press the UHF key.
4. Press the UP ARROW key for approx. 1 second.

#### 8.4.2 DUAL BAND SCANNING WITH MEMORY PRIORITY

If you want to activate PRIORITY on both bands while SCANNING, no problem, follow this example.

EXAMPLE: DUAL BAND SCAN WITH DUAL BAND PRIORITY

1. Press the VHF key.
2. Press the MR key and rotate Main Tuning dial for a desired memory channel.
3. Press the VHF key.
4. Press the SCN key for approx. 1 second.
5. Press the PRI key.
6. Press the UHF key.
7. Press the MR key and rotate Main Tuning dial for a desired memory channel.
8. Press the UHF key.
9. Press the SCN key for approx. 1 second.
10. Press the PRI key.

### 9 REPEATER OPERATIONS

Amateur radio repeaters utilize separate transmitter and receiver sections. The transmitter frequency may be offset either above or below the receive frequency according to repeater coordination conventions.

#### 9.1 SPLIT FREQUENCY FUNCTION

When standard offsets will not satisfy an input or output frequency, a split is utilized for this purpose. Split can be

configured on the DJ-580 for VFO and MEMORY modes. The split frequency function will not operate in CALL mode.

#### 9.1.1 VFO MODE SPLIT

Perform the following for VFO MODE SPLIT.

Page 34

1. Select the Active Band (VFO) by pressing the VHF or UHF key. Enter a frequency into the VFO for your output (receive) frequency.
2. Press the MR key. Program or select a frequency in any MEMORY channel for your input (transmit) frequency.
3. Enter VFO as selected in step 1. VFO frequency is used for receive and the MEMORY channel is used for transmit.
4. Press and hold the FUNC key, then press the SHIFT key repeatedly until the star symbol appears on the display. The split setup is now complete.

#### 9.1.2 MEMORY MODE SPLIT

Perform the following for MEMORY MODE SPLIT.

1. Press the MR key. Program or select a frequency in any MEMORY channel for your input (transmit) frequency.
2. Select the Active Band (VFO) by pressing the VHF or UHF key. Enter a frequency into a VFO for your output (receive) frequency.
3. Press the MR key again. The MR frequency is used for receive and the VFO frequency is used for transmit.
4. Press and hold the FUNC key, then press the SHIFT key repeatedly until the star symbol appears on the display. The split setup is now complete.

#### 9.2 REV KEY

In some areas there may be repeaters operating on repeater frequency pairs, the exact reverse of another repeater in the area. That is, the input of one repeater is the output frequency of the other and vice versa. To avoid the inconvenience of reprogramming every time both repeaters are in range, the REV key allows instant reversal of the input and output frequencies and the offset direction. The REV function is also useful to check the repeater input to determine if another station is heard directly so you can go simplex. To activate the REV function:

1. Press and hold the FUNC key, then press the REV key. The repeater input frequency and opposite SHIFT indicator will appear on the LCD display panel.

2. Press and hold the FUNC key, then press the REV key again to cancel the REV function.

### 9.3 RESETTING RADIO

\*\*\* NOTE \*\*\*

Resetting the radio will erase all user programmed information (frequencies, shifts, offsets etc.) Make sure that this information

Page 35

has been written down before proceeding.

1. Make sure radio is powered off.
2. Press and hold the FUNC key in while turning on the radio via the power knob. The LCD will display 145.00 (VHF) and 445.00 (UHF).

\*\*\* NOTE \*\*\*

If you were to hold the func key in and not let it go while powering up the radio, all display segments will be shown.

### 9.4 CTCSS ENCODE/DECODE

CTCSS encoding allows you to select the proper tone frequency to open another operators radio receiver or repeater. CTCSS decoding enables another operator to select the tone your receiver requires enabling you to hear them. Unlike Code Squelch operation (Refer to section 11 for details), a specific tone frequency is used. Here's how to use CTCSS Encoding/Decoding.

1. Select the Active Band by pressing the VHF or UHF key.
2. Press and hold the FUNC key, then press the TONE key.
3. Rotate the Main Tuning dial to the desired tone.
4. When the tone has been selected enter the Active Band by pressing either the VHF or UHF key.
5. Press and hold the FUNC key, press the T.SQL key repeatedly. Tone settings will cycle each time the T.SQL key is pressed. It cycles as follows on the LCD display:
  - o The Tone Encoder is Enabled when the letter T is displayed on LCD.
  - o The Tone Decoder Squelch function is enabled when the letter T and SQL is displayed on the LCD. When this function is active, you would expect a particular tone to open your radio receiver.
  - o When the T and SQL is not displayed, the encoder/decoder is disabled.

EXAMPLE: TONE ENCODER/DECODER

|                        |                              |
|------------------------|------------------------------|
| Radio for Joe<br>----- | Radio for Linda<br>-----     |
| Tone set: 100.0        | Tone set: 100.0              |
| T displayed (ENCODE)   | T and SQL displayed (DECODE) |

- A) Radio operator "Joe" is calling "Linda". The interesting point here is that when the radio that Linda is using displays T and SQL, nothing will be heard through her radio speaker when squelch is opened up (fully counter

Page 36

clockwise). You will notice however that the S/RF indicator will be shown on the LCD when squelch is opened.

- B) The only way that Linda will hear Joe is for Joe to send the proper tone to open Linda's radio receiver. If Joe doesn't send the right tone, Linda's radio will remain silent.

10 AUTOPATCH OPERATION (AUTOMATIC DIALER)

The DJ-580T/E offers three automatic dialer memories. A telephone number may be entered in either the VHF or the UHF frequency mode. The stored telephone number is transmitted on whichever band is selected as the Active Band.

10.1 PROGRAM AUTODIAL NUMBER

To enter a telephone number, perform the following:

1. Press and hold the FUNC key, then press the A key. The selected VFO frequency display will clear and display C1 or C2 or C3. Rotate the Main Tuning dial clockwise or counter-clockwise to obtain a desired dialer memory. The telephone symbol will display on the LCD and flash, indicating that the dialer memory is ready to accept the number to be stored. You may enter up to 16 numbers, letters and symbols, four at a time in four groups.
2. The telephone number or codes should be entered in order from the beginning. The following characters can be used:  
0-9, A-D, \*, #
3. Press and hold the FUNC key, then press the A key to store the entered telephone number or codes. The telephone symbol stops flashing and is on steady to show that this function is active.

Proceed to Section 10, 10.4 to transmit the dial sequence. Clear out dialer memory to enter a new sequence.

## 10.2 CLEAR DIALER MEMORY

1. Press and hold the FUNC key, then press the A key.
2. Rotate the Main Tuning dial to the dialer memory you wish to clear.
3. Press and hold the FUNC key, then press the C key followed by the A once again.

## 10.3 CORRECTING CODES IN DIALER MEMORY

1. Press and hold the FUNC key, then press the A key.
2. Rotate the Main Tuning dial to the dialer memory you wish to make a correction in.

Page 37

3. Press and hold the FUNC key, then rotate the Main Tuning dial until the sequence of digits you wish to correct have just exited the display.

### EXAMPLE: CORRECTING DIALER CODES

Programmed number is 123567890, but you forgot 4!

1. Press and hold the FUNC key, then press the A key.
2. Rotate the Main Tuning dial to the dialer memory you wish to make a correction in.
3. Press and hold the FUNC key, then rotate the Main Tuning until the numeral 3 is displayed.

```
    This represents the last digit displayed on the LCD.  
    | These digits are hidden just right of last digit shown.  
    v vvvvvv  
123 567890
```

4. Now enter 4567890. After you play with this for awhile you will see how it works.

## 10.4 TRANSMIT/CHANGE AUTODIAL NUMBER

After performing the steps in section 10.1, perform the following steps to transmit the programmed number.

1. Press and hold the FUNC key, then press the "A" key.
2. The telephone symbol could be blinking which represents an unprogrammed dialer memory channel. Refer to Section 10. Otherwise, rotate the main tuning knob to the desired dialer memory channel.

Verify that the blinking telephone symbol appears on the LCD display.

3. Press the PTT switch for an instant. This will return you to VFO mode.
4. To transmit dialer memory channel, Press and hold the PTT key.

\*\* LOOK AT LCD DISPLAY \*\*

You are now transmitting. The ON AIR symbol should display on the LCD display.

5. While transmitting press the FUNC key to send/transmit the autodial sequence.

\*\* LISTEN \*\*

The dialer sequence that you programmed earlier will be transmitted. You can hear the tones that are being sent through the DJ-580 speaker.

Page 38

#### HIDDEN FUNCTIONALITY

This is where you will have to experiment a bit. You can change the dialer sequence timing. Refer to Section 10.7 for all of these new details.

#### 10.5 MANUAL DIAL

In some instances you may want to dial a number manually. perform the following steps.

1. The telephone symbol should not appear on your display. If it does, press and hold the FUNC key, then press the A key, the C key and finally the A key again.
2. Press and hold the PTT key.
3. Now dial the number on your keypad as you would a telephone.

#### 10.6 DISABLE AUTODIAL

Performing the following step will erase a stored number in the autodialer.

1. Press and hold the FUNC key, then press the A key, the C key and finally the A key again.

You can either clear the dialer channel or not press the FUNC key during a transmission.

#### 10.7 DIALER RATE ADJUST

The following steps are used for changing the dialer and DSQ tone rates. This function may not appear/be available on earlier DJ-580 units.

1. Press the \* key. The symbol FL will appear on the LCD display.
2. Press the following keys in sequence: #, 1, 2, 3. The LCD will display the letter C. If you repeat this step continuously the letters will change as follows:

C,D,upside down A,H,0,1,2,3,4,5,6,7,8,9,A,B

Each of these indicators are associated with a different rate during transmission. The fastest begins at 1 and the slowest is zero. The letters are variations of slow rates.

Page 39

## 11 DIGITAL SQUELCH (DSQ)

DSQ stands for DTMF Squelch Control. DSQ is very versatile and will allow you to:

- o Make a transmission that will specifically be heard by a particular group (of your choosing, by a code sequence).
- o Place a private call to a selected person in a group.
- o Call a single operator.
- o Straight DSQ transmission

This feature is achieved by use of DTMF Tones that will either open (or keep closed) the DJ-580T/E. In this section you will learn how to transmit and receive the DSQ SCHEME! A radio must be DSQ compatible to take advantage of these features.

### 11.1 DSQ SCHEME

Before we get started let's look at the DSQ tone structure. Depending on the transmission type (Group, Private etc.), a particular tone sequence will be sent. The tone structure is broken down into the following areas:

- o GROUP Code - 3 digit sequence
- o OTHER'S Code - 3 digit sequence
- o OWN Code - 3 digit sequence
- o MISC Codes

The following explanation of each area will help you to fully understand how each is utilized.

#### 3 DIGIT "GROUP" CODE



By programming a 3 digit group code your members of a group would receive a common transmission. Perhaps this group wouldn't want to hear a transmission meant for another group that has another 3 digit code sequence.

#### EXAMPLE: GROUP CODE

Lets say that you are helping the local police department find a missing child. They have split 10 radio operators into 2-five person teams. Let's call them team 1 and team 2.

Each member of team 1 has a radio with a group code of 111.  
Each member of team 2 has a radio with a group code of 222.

The police have just found evidence that the child is definitely located in team 2 territory. The central transmission point now needs to contact the members of team 1 and notify them that their search area must be changed. They will send out a 111 group code (tone sequence) to team 1. By virtue of the group code 111, all members of team 1 will hear the message and team 2 will hear nothing on their radios. A separate transmission to group 2 could be placed with specific updated information!

Page 40

#### 3 DIGIT "OTHER'S" CODE

This code is used as an identifier of another station. In other words, it is the other persons "own" code.

#### EXAMPLE: OTHERS CODE

Lets say that an individual in team 1 needs to be given some specific information. The receiving stations identifier is referred to as the other's code. We will send that person the information by virtue of their 3 digit "own" code. You must enter their "own" code into your "others" code field.

#### 3 DIGIT "OWN" CODE

A transmitting station uses 3 digits as a personal identification number. A receiving station uses this code to identify who called them.

#### EXAMPLE: OWN CODE

Lets say that you will receive some specific information. The other person will need to know your "own" code before your radio will receive a private call. Your "own" code is also necessary, because the other person receiving your message will see your "own" code displayed on their radio LCD.

#### MISC CODES

16 numbers, letters and symbols can be used for coding. Here's what you can use; 0-9, A-D, \* and #. An "H" will appear on the LCD when the \* is entered and upside down A will appear when the # is entered. The # sign is used as a wild card. Refer to WILDCARD for more information.

## 11.2 PROGRAMMING ALL DSQ CODES

Place your radio in front of you. The following steps get your radio set for DSQ operation.

1. Select the Active Band by pressing the VHF or UHF key.
2. Press and hold the FUNC key, then press the B key. The LCD display will indicate A-000.
3. Enter 3 digits for the group that YOU want to call. In other words, a unique calling code for a specific group.

EXAMPLE: PROGRAM 1ST GROUP CODE

A-123

4. Rotate the Main Tuning dial clockwise until B-000 is displayed on the LCD.
5. Enter 3 digits for another group that YOU might call. This is an additional group calling code.

Page 41

EXAMPLE: PROGRAM 2ND GROUP CODE

B-456

6. Rotate the Main Tuning dial clockwise until P-000 is displayed on the LCD.
7. Enter 3 digits for your "own" Personal code. This is your unique identification code.

EXAMPLE: PROGRAM YOUR OWN CODE

P-100

8. Rotate the Main Tuning dial clockwise until y-000 is displayed on the LCD.
9. And now you must select the "others" 3 digit code. This is the operator you're calling. Lets say you're calling operator 200, enter "200" on the keypad.

EXAMPLE: PROGRAM THE OTHERS CODE

y-200

10. Rotate the Main Tuning dial clockwise until nn-00 is displayed

on the LCD.

11. Enter a two digit code that will become the Digital Signal Message.

EXAMPLE: DIGITAL SIGNAL MESSAGE

nn-07

12. Press the VHF or UHF key to end setup.

Only radios with DSQ functionality are capable of receiving and/or transmitting DSQ tasks. These tasks are described in the following sub-sections, have fun!

### 11.3 DSQ MODES

This section will address all functions of DSQ and describe how they should be used. Only through experimentation of DSQ will you get the hang of it. DSQ functionality comes in various flavors, and they are shown in the following table.

| DSQ FUNCTION               | LCD DISPLAY |
|----------------------------|-------------|
| Straight DSQ               | D.SQ        |
| Group Calling              | G D.SQ      |
| Private Calling In A Group | G P D.SQ    |
| Private Call               | P D.SQ      |

#### 11.3.1 TRANSMITTING (CODE SQUELCH)

Coded Squelch is a unique 3 digit sequence, when sent to another unit configured only for D.SQ, will open the receiver for reception. It's always a good idea to have a cheat card that lists each units identifier (own code) and group codes.

1. Select the Active Band by pressing the VHF or UHF key.
2. Press and hold the FUNC key, then press the B key.
3. Rotate the Main Tuning dial and select either A- for GROUP A or B- for GROUP B. Each group should have a unique identifier code. If either GROUP A or B doesn't contain the desired 3 digit code, enter it in at this time via the keypad.
4. Return to the Active Band as selected in step 1.
5. Press the B key several times until "D.SQ" displays on the upper right-hand corner of the LCD.
6. When you press the PTT key, the Code Squelch is transmitted automatically. At the conclusion of the 3 digits being

transmitted, the operators radio (who you are calling) receiver will accept your transmission.

#### 11.3.2 RECEIVING (CODE SQUELCH)

If the received Code Squelch signal matches the set Code Squelch code, D.SQ will begin to flash on the LCD display. In addition, an audible alert will be heard through the speaker.

If the receiver is on receive mode by code squelch, it is possible to communicate within 1.5 seconds after a received signal is clipped.

#### 11.3.3 TRANSMITTING (GROUP CALLING)

When you select this option, you will be able to contact many operators that collectively make up a group. If operators with compatible DSQ functionality are configured correctly, and all have the same group code programmed, their radios should open and receive your call. It's always a good idea to have a cheat card that lists each units identifier (own code) and group codes. Here's what you have to do.

1. Press the B key.
2. Rotate the Main Tuning dial and select either A- for GROUP A or B- for GROUP B. Each group should have a unique identifier code.
3. Press the B key several times until G D.SQ displays on the upper right-hand corner of the LCD.
4. When you press the PTT switch, the GROUP code selected will be transmitted to all units in the GROUP.

Page 43

If you are using GROUP A in step 2 and wish to change to GROUP B, follow steps 1-4 again.

The following DSQ code is transmitted as shown:

(3 DIGIT GROUP CODE) \* (3 DIGIT OWN CODE)

#### 11.3.4 RECEIVING (GROUP CALLING)

To receive DSQ coded calls in GROUP CALLING, setup your radio for G DSQ as follows:

1. Press and hold the FUNC key, then press the B key until G DSQ appears on the LCD display.

When the received DSQ code matches the first 3 digits of your display (group code), the G DSQ indicator will begin to flash. If the BEEP is off, the squelch will open for as long as the calling operator is transmitting. If the BEEP is on, an audible beep will be emitted from the radio and the indicator will display which

group is calling. Reset the display by pressing the Active Band key or PTT.

#### 11.3.5 TRANSMITTING (PRIVATE CALLING IN A GROUP)

It's always a good idea to have a cheat card that lists each units identifier (own code) and group codes.

1. Press the B key.
2. Rotate the Main Tuning dial and select either A- for GROUP A or B- for GROUP B. Each group should have a unique identifier code.
3. Press the B key several times until GPDSQ displays on the upper right-hand corner of the LCD.
4. Press the PTT switch to transmit the DSQ code or press the VFO key for the band you are working.

The following DSQ code is transmitted as shown:

(3 DIGIT GROUP CODE) (1 DIGIT OTHERS CODE) \* (1 DIGIT OWN CODE)

#### 11.3.6 RECEIVING (PRIVATE CALLING IN A GROUP)

To receive DSQ coded calls in PRIVATE CALL IN A GROUP, setup your radio for GPDSQ as follows:

1. Press the B key until GPD.SQ appears on the LCD display.

When the received DSQ code matches the first 3 digits of your group and your own code, the DSQ GP indicator will begin to flash. If the BEEP is off, the squelch will open for as long as the calling operator is transmitting. If the BEEP is on, an audible beep will

be emitted from the radio and the indicator will display which group is calling. Reset the display by pressing the Active Band key or PTT.

#### 11.3.7 TRANSMITTING (PRIVATE CALL)

This option would be used when someone is calling only you. This is different from encode/decode because you determine your own identification code and not a subaudible tone. It's always a good idea to have a cheat card that lists each units identifier (own code) and group codes.

1. Press the B key.
2. Press the B key several times until P D.SQ displays on the upper right-hand corner of the LCD.

3. Press the PTT key to transmit the DSQ code or press the VFO key for the band you are working.

The following DSQ code is transmitted as shown:

(3 DIGIT OTHERS CODE) \* (3 DIGIT OWN CODE)

#### 11.3.8 RECEIVING (PRIVATE CALL)

To receive DSQ coded calls in PRIVATE CALL, setup your radio for P D.SQ as follows:

1. Press and hold the FUNC key, then press the B key until P D.SQ appears on the LCD display.

#### 11.4 ERROR CODE

When the "Other's" private code is not confirmed the LCD display will indicate "Er".

#### 11.5 TIMING CONSIDERATIONS

On occasions you may find that the operation of DSQ through some older repeaters may be unpredictable. This occurs on initial transmit with your DJ-580. When you transmit, a time delay occurs before the repeater is fully transmitting. The DJ-580 will begin to transmit the DSQ tone sequence during the repeater transmit delay. The DJ-580 can delay 450 ms or 750 ms. In addition, the timing period for the tone burst sequence can be adjusted. Please refer to section 10.7 for more information.

It is possible to delay the time to transmit codes to about 750ms after the PTT key is pressed.

1. Press and hold the FUNC key, then press the \* key. The LCD display will display FL.
2. Press and hold the FUNC key, then press the 4 key. The LCD display will display d-750 or d-450. Repeat this step until the desired selection is made.

Page 45

3. Press and hold the FUNC key, then press the \* key. Repeat this step until FL and PL is absent from the display.

#### 11.6 DSQ WILDCARDS

The # symbol is a wildcard that may be substituted for any one digit, letter or symbols used in DSQ codes. When the # symbol is entered it appears on the LCD display as an upside down A. The wildcard allows for the combination of many groups. If the first or first and second digits of several group codes are the same, you can replace the second and third digits (or just third digit) with a # mark, and thus transmit to all those groups.

EXAMPLE: WILDCARDS

1. Enter the 2 meter frequency of 146.520.
2. Press and hold the FUNC key, then press the DSQS key. Select any code squelch memory channel.
3. Release the FUNC key now and select a 3 digit code squelch code using the keypad.

Example: Enter the 3 digit code 1#5.

4. Press the FUNC key to return the LCD display to operating frequency.

Example: Now you will see on the LCD display P45.52.

5. Press the D.SQL key repeatedly (2 times) until C appears in the 100 MHz digit location.

Example: C45.620

If the incoming coded calls are anyone with a group code as follows, the call will be received by your radio.

- o 105 through 195
- o 1A5 through 1D5
- o 1\*5
- o 1#5

6. When you receive a call from another station, the C will flash on and off for as long as the other operator is transmitting. Your radio has already memorized who was calling you, so press the PTT switch and you will transmit to that station directly. When you have completed your QSO, enter the wildcard sequence again to open your radio to all other stations again.

## 11.7 DIGITAL SIGNAL MESSAGE

This function allows you to send or receive messages consisting of 2 digit codes.

Page 46

### 11.7.1 TRANSMITTING DIGITAL SIGNAL MESSAGE

You can retain 1 signal message in the transmitter memory.

1. Press and hold the FUNC key, then press the B key.
2. Rotate the Main Tuning dial and select a message memory channel nn.
3. Enter a 2 digit message code. This is a code that has been predetermined and understood by the operating parties.

4. Press the VHF or UHF key to end setup.
5. Set the appropriate paging function (D.SQ, G D.SQ etc).
6. Press the PTT key to transmit the DSQ code. Continue to hold the PTT key and press the CALL key.

What the receiving operator will see on the display will be the unit number of the calling station followed by the 2 digit code. The following is the sequence sent:

# (2 DIGIT SIGNAL MESSAGE)

#### 11.7.2 RECEIVING DIGITAL SIGNAL MESSAGE

1. Set the appropriate paging function (D.SQ, G D.SQ etc).
2. When the appropriate codes are received, your receiver will open to hear the calling operator. When the digital signal message is sent shortly after the initial transmission, you will see on the LCD display the 3 digit calling station followed by a - and then the 2 digit digital signal message.

#### 11.7.3 TRANSMITTING WITH DIGITAL SIGNAL DISPLAYED

While a digital signal message is displayed, press the PTT switch. Your signal will be transmitted back to the station calling by using the displayed DSQ settings. The frequency will return to your LCD display.

#### 11.7.4 REVIEW DIGITAL SIGNAL MESSAGE MEMORY

You can store up to 3 previously received digital signal messages. The first two memories store the messages in received order. The third memory stores the latest message. These messages display the 3 digit calling station followed by the 2 digit message. Here's how to view digital signal message memory.

1. Press and hold the FUNC key, then press the MESS key. Select any code squelch memory channel. The latest message will be displayed on the LCD display.
2. Rotate the Main Tuning dial to review the previously sent messages in n1 through n2. You can also use the arrow keys to review these messages.

Page 47

#### 11.7.5 CLEARING MESSAGE MEMORY

If you find it necessary to clear out messages, proceed with the following steps.

1. Select the memory number and press the C key once to clear out that location.



The DJ-580 is capable of cross band repeat. To simplify matters, it means that when you transmit on one band it is simultaneously heard on the other band. Ok you want to set up a cross band repeater? Here are a few things to remember about cross band repeat:

1. When cross band repeat is active, you cannot change frequencies or utilize other functions with the exception of cross band deactivation.
2. Set squelch threshold before you activate cross band repeat.
3. No radio modification is necessary to activate this function.
4. This isn't a 100% duty cycle repeater. If the radio becomes extremely hot to the touch, the radio should be allowed a cool down time.
5. Use cross band repeat in either Low or Mid power only.
6. Cross band repeat will not allow for different CTCSS Encode/Decode tones on each band.

Using cross band repeat allows a user to enter on one band and cross over to the other band. You may use shifts or operate in simplex operation.

#### 12.1 ACTIVATE CROSS BAND REPEATER

Here are the steps for cross band repeat.

1. Rotate the volume controls for the VHF and UHF bands fully counter-clockwise.
2. Press and hold the FUNC key, then press the FL key. The LCD should display FL.
3. Press each key once as follows: #, 5, 0 and 8. You should notice that the word oPEn displays on the LCD and the opposite band indicator will begin to blink. The radio is now in cross band repeat. When a signal is received on one band, it will be retransmitted onto the other band.

#### 12.2 DEACTIVATE CROSS BAND REPEATER

To return to original mode perform the following:

1. Press and hold the FUNC key, then you will press the FL/PL key

4 times. After you press it the first time the LCD will display CLoSE. This indicates to you that cross band repeat has been disabled. The other 3 times that you press the FL/PL key will turn off the FL and PL indicators.

13 FULL DUPLEX OPERATION

The principles of Full Duplex operation is very much like a telephone. The idea behind this is that when you are talking (let's say) on 2 meters you will hear the transmission from the other station on the 440 band. He will hear you on 2 meters.

| YOUR STATION         | OTHER STATION        |
|----------------------|----------------------|
| TRANSMIT ON 2 METERS | RECEIVE ON 2 METERS  |
| RECEIVE ON 440 BAND  | TRANSMIT ON 440 BAND |

13.1 ENABLE SPEAKER FULL-DUPLEX

Enabling the speaker will cause feedback unless an external earphone or headset is used.

1. Press and hold the FUNC key, then press the \* key. The LCD should display FL.
2. Press and hold the FUNC key, then press the 5 key. The LCD should display Fd-on. Repeat this step until the field indicates Fd-on.
3. Press and hold the FUNC key, then press the FL/PL key repeatedly until the FL and PL indicators are absent from the LCD display.

13.2 DISABLE SPEAKER SEMI-DUPLEX

Perform the following steps:

1. Press and hold the FUNC key, then press the \* key. The LCD should display FL.
2. Press and hold the FUNC key, then press the 5 key. The LCD should display Fd-oF. Repeat this step until the field indicates Fd-oF.
3. Press and hold the FUNC key, then press the FL/PL key repeatedly until the FL and PL indicators are absent from the LCD display.

14 AIRCRAFT RECEIVE MODIFICATION

The radio will have to be opened and modified to receive aircraft and some frequencies in the 800 and 900Mhz region. This procedure isn't difficult if you take your time. If you are unsure of your ability to open and/or perform this mod, please find someone with this know how!

\*\*\* NOTE \*\*\*

Don't even think of performing this modification unless you have the right tools and temperament.

1. Turn the radio off and remove the battery pack.
2. CAREFULLY remove the 4 phillips screws on the bottom of the radio. These screws represent each corner of the bottom of the radio.

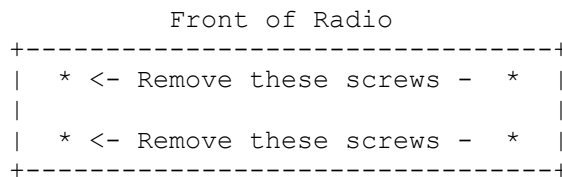

BOTTOM VIEW OF RADIO SHOWN

3. You are about to remove the battery connector plate. There are wires connected to this plate. When moving the plate out of the way, don't pull further then you have to in order to see into the bottom of the radio. Locate a BRIGHT RED LOOPED WIRE. Remove or cut (tape exposed ends) this jumper. That's all there is folks!

\*\*\* WARNING \*\*\*

You should be extremely careful not to cut the wrong wire. You may cut the BRIGHT RED LOOPED WIRE. Don't cut the pink or orange wire by mistake.

4. Take your time and reassemble the radio. Make sure that during reassembly that you:
  - o Don't forget to place long tension arm (part of the battery connector plate) into the battery lock clip located on the same side of the radio as the PTT switch.

REMEMBER, be patient and take your time. Never force anything together! It came apart easily, it should go back together that way.

5. Reset the radio (Section 9.3) and enjoy a hot aircraft receiver. You will be able to enter a frequency range from 108-173.995MHz. The receiver will actually begin to receive around 110 MHz. Another way to gain access into the airband is, press the "FUNC" button while pressing the "VHF" key.

\*\*\* MULTI BAND RECEIVE \*\*\*

After you modified your DJ-580 for Airband, you also enable coverage for some frequencies in the 800 and 900Mhz region. To receive coverage in this area, you can enter the frequency directly from the keypad or press the "FUNC" button while pressing the "UHF" key. The STEP key in regions will only allow increments of 10, 12.5, 20 and 25KHz.

\*\*\* NOTE \*\*\*

If you see a second decimal point blink in the frequency displayed, this means that the PLL circuitry isn't locked.

Example: 108.0.0

^\_\_\_\_ This decimal point will blink.

ACCESSORIES

|                                             |       |
|---------------------------------------------|-------|
| OPTIONAL. . . . .                           | 1     |
| STANDARD. . . . .                           | 1     |
| AIRCRAFT RECEIVE. . . . .                   | .50   |
| ANTENNA CONNECTOR . . . . .                 | .15   |
| APO KEY . . . . .                           | .10   |
| AUTO POWER OFF INDICATOR. . . . .           | .18   |
| AUTOMATIC DIALER (AUTODIAL) . . . . .       | .37   |
| CLEAR DIALER MEMORY . . . . .               | .37   |
| CORRECTING CODES IN DIALER MEMORY . . . . . | .37   |
| DIALER RATE ADJUST. . . . .                 | .39   |
| DISABLE AUTODIAL. . . . .                   | .39   |
| MANUAL DIAL . . . . .                       | .39   |
| PROGRAMMING AUTODIAL NUMBER . . . . .       | .37   |
| TRANSMIT/CHANGE AUTODIAL NUMBER . . . . .   | .38   |
| BATTERY . . . . .                           | 3     |
| APO KEY . . . . .                           | .10   |
| BATTERY SAVE INDICATOR. . . . .             | .17   |
| BS KEY. . . . .                             | .14   |
| EBP-20N . . . . .                           | 3     |
| EBP-22N . . . . .                           | 4     |
| LOCK BUTTON . . . . .                       | .17   |
| LOW LEVEL BATTERY MODE. . . . .             | .23   |
| BEEP KEY. . . . .                           | .10   |
| BNC ANTENNA CONNECTOR . . . . .             | .15   |
| BS KEY. . . . .                             | .14   |
| CALL KEY. . . . .                           | .14   |
| CALL MODE . . . . .                         | .26   |
| ACTIVATING CALL CHANNEL . . . . .           | .27   |
| CALL KEY. . . . .                           | .14   |
| COPY TO VFO FUNCTION. . . . .               | .27   |
| PROGRAMMING THE CALL CHANNEL. . . . .       | .26   |
| CALL PRIORITY . . . . .                     | .28   |
| CALL.W KEY. . . . .                         | .14   |
| CALL WRITE (CALL.W) KEY . . . . .           | .14   |
| CLEARING ENTRY. . . . .                     | .21   |
| CONTROL KEY PAD . . . . .                   | 5, 20 |
| CLEARING ENTRY. . . . .                     | .21   |
| KEY PAD DIRECT ENTRY. . . . .               | .20   |
| CROSS BAND REPEATER . . . . .               | .48   |
| ACTIVATE CROSS BAND REPEAT. . . . .         | .48   |
| DEACTIVATE CROSS BAND REPEAT. . . . .       | .49   |
| CTCSS ENCODE/DECODE . . . . .               | .36   |
| DECODE. . . . .                             | .36   |
| DESCRIPTIONS. . . . .                       | 4     |
| APO KEY . . . . .                           | .10   |
| BEEP KEY. . . . .                           | .10   |
| BNC ANTENNA CONNECTOR . . . . .             | .15   |
| CALL/CALL.W KEY . . . . .                   | .14   |
| CONTROL KEY PAD . . . . .                   | 5     |
| DOWN ARROW AND FL/PL KEY. . . . .           | .11   |
| DUAL KEY. . . . .                           | .11   |
| GP DSQ/DSQS KEY . . . . .                   | .12   |

|                             |       |
|-----------------------------|-------|
| LAMP KEY. . . . .           | .14   |
| LCD DISPLAY PANEL . . . . . | 5, 17 |
| MAIN TUNING DIAL. . . . .   | .15   |
| MESS KEY. . . . .           | .12   |

|                                                 |                       |
|-------------------------------------------------|-----------------------|
| MIC JACK. . . . .                               | .16                   |
| MICROPHONE. . . . .                             | 5                     |
| MONI/BS KEY . . . . .                           | .14                   |
| MR/MW KEY . . . . .                             | .12                   |
| PO KEY. . . . .                                 | 8                     |
| POWER ON/OFF CONTROL. . . . .                   | .15                   |
| PRI/DIAL M KEY. . . . .                         | .12                   |
| REV KEY . . . . .                               | 7, 35                 |
| SCN/PS KEY. . . . .                             | .13                   |
| SHIFT KEY . . . . .                             | 5                     |
| SKIP/M TO V KEY . . . . .                       | .12                   |
| SPEAKER . . . . .                               | 5                     |
| SPEAKER JACK. . . . .                           | .16                   |
| STEP KEY. . . . .                               | 6, 21                 |
| T.SQL KEY . . . . .                             | 9                     |
| TMS/VCS KEY . . . . .                           | .10                   |
| TONE KEY. . . . .                               | 8                     |
| UHF BAND KEY. . . . .                           | 5                     |
| UHF SQUELCH . . . . .                           | .15                   |
| UHF VOLUME CONTROL. . . . .                     | .15                   |
| UP ARROW AND MESS KEY . . . . .                 | .12                   |
| V.U.SPEAKER JACK. . . . .                       | .16                   |
| VHF BAND KEY. . . . .                           | 5                     |
| VHF SQUELCH . . . . .                           | .15                   |
| VHF VOLUME CONTROL. . . . .                     | .15                   |
| DIAL M KEY. . . . .                             | .12                   |
| DIALER. . . . .                                 | .SEE AUTOMATIC DIALER |
| DIGITAL SIGNAL MESSAGE. . . . .                 | .46                   |
| TRANSMITTING. . . . .                           | .47                   |
| RECEIVING . . . . .                             | .47                   |
| REVIEW MESSAGE MEMORY . . . . .                 | .47                   |
| CLEARING MESSAGE MEMORY . . . . .               | .48                   |
| DOWN ARROW KEY. . . . .                         | .11                   |
| DSQ                                             |                       |
| CLEARING MESSAGE MEMORY . . . . .               | .47                   |
| DIGITAL SIGNAL MESSAGE. . . . .                 | .46                   |
| DIGITAL SQUELCH . . . . .                       | .40                   |
| DSQ MODES . . . . .                             | .42                   |
| ERROR CODE. . . . .                             | .45                   |
| PROGRAMMING ALL DSQ CODES . . . . .             | .41                   |
| RECEIVING (CODE SQUELCH). . . . .               | .43                   |
| RECEIVING (GROUP CALLING) . . . . .             | .44                   |
| RECEIVING (PRIVATE CALL). . . . .               | .45                   |
| RECEIVING (PRIVATE CALLING IN A GROUP). . . . . | .44                   |
| RECEIVING DIGITAL SIGNAL MESSAGE. . . . .       | .47                   |
| REVIEW DIGITAL SIGNAL MESSAGE MEMORY. . . . .   | .47                   |
| SCHEME. . . . .                                 | .40                   |
| TIMING CONSIDERATIONS . . . . .                 | .45                   |
| TRANSMITTING (CODE SQUELCH) . . . . .           | .43                   |
| TRANSMITTING (GROUP CALLING). . . . .           | .43                   |

|                                             |     |
|---------------------------------------------|-----|
| TRANSMITTING (PRIVATE CALL)                 | .45 |
| TRANSMITTING (PRIVATE CALLING IN A GROUP)   | .44 |
| TRANSMITTING DIGITAL SIGNAL MESSAGE         | .47 |
| TRANSMITTING WITH DIGITAL SIGNAL DISPLAYED. | .47 |
| WILDCARDS                                   | .46 |
| DSQS KEY.                                   | .12 |
| DUAL KEY.                                   | .11 |

|                                 |         |
|---------------------------------|---------|
| DUAL WATCH.                     | .29     |
| CALL/MEMORY                     | .30     |
| CALL/VFO.                       | .30     |
| DUAL KEY.                       | .11     |
| PRIORITY/DUAL WATCH INDICATOR   | .18     |
| VFO/MEMORY.                     | .29     |
| ENCODE.                         | .36     |
| FL/PL KEY                       | .11     |
| FREQUENCY                       |         |
| FREQUENCY INDICATOR             | .18     |
| STEP KEY.                       | 6, 21   |
| FREQUENCY COVERAGE              |         |
| AMERICAN.                       | 2       |
| EUROPEAN.                       | 2       |
| FRONT PANEL                     |         |
| LCD DISPLAY                     | .17     |
| FRONT PANEL CONTROLS/FUNCTIONS. | 5       |
| FULL DUPLEX OPERATION           | .49     |
| FUNCTION KEY.                   | .16     |
| GP DSQ KEY.                     | .12     |
| INTRODUCTION.                   | 1       |
| LAMP KEY.                       | .14     |
| LCD DISPLAY DESCRIPTIONS.       | 5, 17   |
| AM.                             | .18     |
| APO (AUTO POWER OFF).           | .18     |
| BATTERY SAVE.                   | .17     |
| DIALER.                         | .18     |
| DSQ INDICATOR                   | .18     |
| FL (FREQUENCY LOCK)             | .19     |
| FREQUENCY DECIMAL POINT         | .19     |
| FREQUENCY INDICATOR             | .18     |
| MEMORY CHANNEL.                 | .17     |
| ON AIR.                         | .18     |
| OUTPUT POWER.                   | .18     |
| PL (PTT LOCK)                   | .19     |
| PRIORITY/DUAL WATCH             | .18     |
| S/RF.                           | .19     |
| SHIFT                           | .18     |
| SPLIT                           | .18, 35 |
| TIMER SCAN.                     | .18     |
| TONE ENCODER/TONE SQUELCH       | .17     |
| TONE FREQUENCY DECIMAL POINT.   | .19     |
| UHF                             | .19     |
| VHF                             | .18     |
| LEFT SIDE CONTROLS              |         |
| BATTERY LOCK BUTTON             | .17     |
| FUNCTION KEY.                   | .16     |

|                                         |     |
|-----------------------------------------|-----|
| PTT SWITCH. . . . .                     | .16 |
| LOW LEVEL BATTERY MODE. . . . .         | .23 |
| M TO V (MEMORY to VFO) KEY. . . . .     | .12 |
| MAIN TUNING DIAL. . . . .               | .15 |
| MEMORY CHANNEL                          |     |
| SKIP MODE . . . . .                     | .32 |
| MEMORY MODE . . . . .                   | .23 |
| ALLOCATION OF MEMORY CHANNELS . . . . . | .25 |
| CANCELLING A MEMORY CHANNEL . . . . .   | .25 |
| MEMORY TO VFO COPY FUNCTION . . . . .   | .26 |

|                                                 |         |
|-------------------------------------------------|---------|
| MEMORY MODE (CONTINUED)                         |         |
| PROGRAMMING A MEMORY CHANNEL (MW KEY) . . . . . | .23     |
| SCROLL MEMORY . . . . .                         | .24     |
| SPLIT . . . . .                                 | .35     |
| MEMORY PRIORITY . . . . .                       | .28     |
| MEMORY SCAN . . . . .                           | .32     |
| MEMORY CHANNEL SKIP MODE. . . . .               | .32     |
| MESS KEY. . . . .                               | .12     |
| MICROPHONE. . . . .                             | 5       |
| MICROPHONE JACK . . . . .                       | .16     |
| MODIFICATION                                    |         |
| AIRCRAFT RECEIVE. . . . .                       | .50     |
| MONI KEY. . . . .                               | .14     |
| MONO BAND FUNCTION. . . . .                     | .22     |
| MR KEY. . . . .                                 | .13, 24 |
| MR/MW KEY . . . . .                             | .13     |
| MW KEY. . . . .                                 | .13, 23 |
| PO (POWER OUTPUT) KEY . . . . .                 | 8       |
| POWER                                           |         |
| APO KEY . . . . .                               | .10     |
| BS KEY. . . . .                                 | .14     |
| DC IN JACK. . . . .                             | .17     |
| EBP-20N BATTERY . . . . .                       | 3       |
| EBP-22N BATTERY . . . . .                       | 4       |
| GENERAL POWER READINGS. . . . .                 | 4       |
| LCD OUTPUT POWER INDICATOR. . . . .             | .18     |
| ON/OFF CONTROL. . . . .                         | .15     |
| OUTPUT SETTING. . . . .                         | .22     |
| PO KEY. . . . .                                 | 8       |
| PRI KEY . . . . .                               | .12     |
| PRIORITY/DUAL WATCH INDICATOR . . . . .         | .17     |
| PRIORITY FUNCTIONS. . . . .                     | .27     |
| CALL PRIORITY . . . . .                         | .28     |
| MEMORY PRIORITY . . . . .                       | .28     |
| VFO PRIORITY. . . . .                           | .27     |
| PS KEY                                          |         |
| PROGRAMMABLE SCAN (PS) Key. . . . .             | .13     |
| PTT SWITCH. . . . .                             | .16     |
| REPEATER OPERATIONS . . . . .                   | .34     |
| MEMORY MODE SPLIT . . . . .                     | .18, 35 |
| REV KEY . . . . .                               | .35     |
| SPLIT FREQUENCY FUNCTION. . . . .               | .18, 34 |
| VFO MODE SPLIT. . . . .                         | .18, 34 |
| RESETTING RADIO . . . . .                       | .35     |



|                                         |       |
|-----------------------------------------|-------|
| REV KEY . . . . .                       | 7, 35 |
| RIGHT SIDE CONTROLS                     |       |
| DC IN JACK. . . . .                     | .17   |
| SCANNING. . . . .                       | .30   |
| DUAL BAND SCAN. . . . .                 | .33   |
| DUAL BAND WITH MEMORY PRIORITY. . . . . | .34   |
| MEMORY SCAN . . . . .                   | .32   |
| PROGRAM BAND SCAN MODE. . . . .         | .31   |
| TYPES . . . . .                         | .33   |
| VFO SCAN. . . . .                       | .31   |
| SCN KEY . . . . .                       | .13   |

|                                               |         |
|-----------------------------------------------|---------|
| SHIFT KEY . . . . .                           | 5       |
| SHIFT INDICATOR . . . . .                     | .18     |
| SPLIT SHIFT INDICATOR . . . . .               | .17, 35 |
| SKIP KEY. . . . .                             | .12, 33 |
| SPEAKER . . . . .                             | 5       |
| JACK. . . . .                                 | .16     |
| VHF/UHF SPEAKER JACK. . . . .                 | .16     |
| ENABLE SPEAKER FULL DUPLEX. . . . .           | .49     |
| DISABLE SPEAKER SEMI DUPLEX . . . . .         | .49     |
| SPECIFICATIONS. . . . .                       | 2       |
| AMERICAN FREQUENCY COVERAGE . . . . .         | 2       |
| BATTERY . . . . .                             | 3       |
| EBP-20N BATTERY . . . . .                     | 4       |
| EUROPEAN FREQUENCY COVERAGE . . . . .         | 2       |
| GENERAL . . . . .                             | 2       |
| RECEIVER. . . . .                             | 3       |
| TRANSMITTER . . . . .                         | 3       |
| SQUELCH                                       |         |
| UHF . . . . .                                 | .15     |
| VHF . . . . .                                 | .15     |
| STEP KEY. . . . .                             | 6, 21   |
| T.SQL (TONE SQUELCH) KEY. . . . .             | 9       |
| TMS KEY                                       |         |
| TIMED MEMORY SCAN (TMS) KEY . . . . .         | .10     |
| TIMER SCAN INDICATOR. . . . .                 | .18     |
| TONE KEY. . . . .                             | 8       |
| TONE SQUELCH (T.SQL) KEY. . . . .             | 9       |
| TONE ENCODER/TONE SQUELCH INDICATOR . . . . . | .17     |
| TOP PANEL                                     |         |
| BNC ANTENNA CONNECTOR . . . . .               | .15     |
| CONTROLS AND FUNCTIONS. . . . .               | .15     |
| MAIN TUNING DIAL. . . . .                     | .15     |
| POWER ON/OFF AND UHF VOLUME CONTROL . . . . . | .15     |
| SPEAKER JACK. . . . .                         | .16     |
| UHF SQUELCH . . . . .                         | .15     |
| VHF SQUELCH . . . . .                         | .15     |
| VHF VOLUME CONTROL. . . . .                   | .15     |
| TRANSCEIVER MODES . . . . .                   | .23     |
| CALL MODE . . . . .                           | .26     |
| MEMORY MODE . . . . .                         | .23     |
| VFO . . . . .                                 | .23     |

|                                 |     |
|---------------------------------|-----|
| TRANSMITTING. . . . .           | .22 |
| LOW LEVEL BATTERY MODE. . . . . | .22 |
| POWER OUTPUT SETTING. . . . .   | .22 |
| UHF                             |     |
| BAND KEY. . . . .               | 5   |
| INDICATOR . . . . .             | .19 |
| SQUELCH . . . . .               | .15 |
| VOLUME CONTROL. . . . .         | .15 |
| UP ARROW KEY. . . . .           | .12 |
| VFO MODE. . . . .               | .23 |
| SPLIT . . . . .                 | .34 |
| VFO PRIORITY. . . . .           | .27 |
| VFO SCAN. . . . .               | .31 |

|                         |     |
|-------------------------|-----|
| VHF                     |     |
| BAND KEY. . . . .       | 5   |
| INDICATOR . . . . .     | .18 |
| SQUELCH . . . . .       | .15 |
| VOLUME CONTROL. . . . . | .15 |
| VOLUME CONTROL          |     |
| UHF . . . . .           | .15 |
| VHF . . . . .           | .15 |
| W KEY . . . . .         | .26 |





From: jay@zen.CAc.stratus.COM (Jay Appell)  
Subject: ALINCO F1 2 METER HANDHELD  
Date: 7 Jun 91 18:43:34 GMT  
Organization: UCSD Usenet Gateway  
Lines: 19

There are two mods immediately available!

First, If you haven't seen this little handheld, look for it!

This is like having a solid little Motorola in your palm. The sensitivity is very very good! I'm impressed so far!

First Mod: Open the back of the radio and discover a Red Wire. Cut the red wire. Re-assemble the radio. Reset the radio and voila you now have airband! press the B key and airband receive mod is complete.

Second Mod : Perform everything like the first mod except find a Blue added wire. Cut the wire for broadband. Reset radio and your done.

More later.....

Jay Appell (KA1SNA)



Newsgroups: rec.radio.amateur.misc  
From: jtg0707@uxa.cso.uiuc.edu (Jui Tien)  
Subject: Alinco DJF1T mods  
Message-ID: <Bw9xtH.9zz@news.cso.uiuc.edu>  
Summary: Mods for extended receive and transmit  
Sender: usenet@news.cso.uiuc.edu (Net Noise owner)  
Organization: University of Illinois at Urbana  
Date: Sat, 17 Oct 1992 16:29:39 GMT  
Keywords: Alinco  
Lines: 38

First of all, thanks for all the people who sent me email on the DJF1T mods. I've tried it and it works!!  
Here is the summary:

Open the radio and place it face down with the BNC jack up, and locate two jumper wires on the lower right hand corners of the set. The red jumper is for extended receive, and the blue(I think it is blue?) jumper is for extended transmit. Just cut/unsolder the red jumper for extended receive, blue for extended transmit, or both jumpers if you want both.

Push the F button while turning the set on to reset radio to factory defaults. The extended receive (AM aircraft) can be activated by pressing the B button on the keypad. (If you cut both jumpers) A letter A will show up on the LCD indicating that radio is in the AM mode. To go back to FM, just press B again. I think B just activates a second VFO in the radio, since radio retains the AM frequency when toggle in and out of te AM mode. My serial number is 8221, so this mod should work for radio with serial numbers close to mine. The radio will not transmit in AM mode, but it will transmit up to the ~160MHz range. I can say that it works up to the weather band frequencies. I've checked it by transmitting on 162MHz to a FT-415 at the lowest power setting inside an enclosed screen room.

Try this mod at your own risk!

A few words about the radio in general. I had the radio for about two days and I already had several IFR flights with it on board an airplane. The radio performed flawlessly. The fit and finish of the radio is excellent. The entire radio case is cast luminum, except the battery case, which is plastic. The only gripe I have about the radio is the battery latch. It seems to do the job, but looks a little flimsy. If I really squeeze the radio HARD, I can feel a tiny bit of movement between the battery case and radio. But I complaint about the same thing about the glove compartment in my Honda....  
I prefer the what we pilots called " human engineerd" aspect of the radio. Most of what I use in the airplane are rarely more than two buttons away. God only gave me two hands a while back, and I need one to fly the airplane, and the other to toggle the radio controls.  
Cheers

J.T.





From: wa2ise@cbnewsb.cb.att.com (robert.f.casey)  
Subject: DR110 mod file  
Keywords: mods  
Date: 3 Jul 91 00:21:52 GMT  
Organization: AT&T Bell Laboratories  
Lines: 20

copied from packet:

>From: "CARTY ELLIS (KA2Y)" <CELLIS@BROCKVMA>  
>Subject: ALINCO DR-110T MODS

To broadband the DR-110T, while holding the "F" and "VFO/M" keys down, turn off the power and then turn it back on (still holding the keys). The radio now has factory programming reset - you just lost your memories but at least mine now transmits and receives from 130 Mhz to 169 Mhz. Before you do this, remove the top cover - notice the long (2 inchish) loop of yellow wire coming off the back of the front panel - clip it! NOW - after resetting the microprocessor - press the "F" key, then press the "Mhz" key (mine now says 370). press the "f" key again, then press the "Mhz" key again - (mine now says 870!). Mine will scan from 870.000 to 889.995 Mhz. I selected a 15Khz step because the channel spacing in this range is 30 Khz. Toggle the "F" and "Mhz" keys and you're back at 144 mhz. Enjoy.

-----  
Note: I haven't tried or verified this, proceed at your own risk. WA2ISE



Article 3527 of rec.radio.amateur.packet:  
Newsgroups: rec.radio.amateur.packet  
Path: west.West.Sun.COM!sun-barr!cs.utexas.edu!wupost!zaphod.mps.ohio-  
state.edu!pacific.mps.ohio-state.edu!linac!att!cbfsb!cbnewsb.cb.att.com!wa2ise  
From: wa2ise@cbnewsb.cb.att.com (robert.f.casey)  
Subject: 9600 baud mod for Alinco 110, 112, 1200 radios  
Message-ID: <1992Jul26.043534.23205@cbfsb.cb.att.com>  
Sender: news@cbfsb.cb.att.com  
Organization: AT&T  
Date: Sun, 26 Jul 1992 04:35:34 GMT  
Lines: 50

copied from packet:

| Msg# | TSF | Size | #Rd | Date   | Time | From   | MsgID    | To              |
|------|-----|------|-----|--------|------|--------|----------|-----------------|
| 2183 | BF  | 3482 | 0   | 21-Jul | 1657 | KC6RIX | 476_WF60 | ALINCO@USBBS () |

Sb: 110, 112, 1200 MODS SAME!

Hello FELLOW Packeteers! I just got off the phone with Matt from Alinco! I have been asked if the 9600 baud Mod that I posted would also work for the 110. YES IT WILL! The 110, 112 and 1200 radios are identical except for the power output of the 1200 (25-watts high power compared to the 45-watts of the 110 and 112!) and the 112 has a LCD display to replace the piece of junk one on the 110! Also, if you want to have more power in the 1200, you can buy the 100/112 PA Board (45-watts) for \$65.00 from Alinco. It also requires buying 4 high power switching diodes for \$20.00 from Alinco. \$85.00 for 20-watts?...Doesn't sound like a good investment to me. Don't forget the time involved with doing this mod. I discourage the use of HIGH POWER and have posted bulletins on this subject! Never the less, I feel obligated to pass this info on to you, I am not the U.S. Government, I will NOT keep things from you! To follow is the 9600 baud Mod I received from Alinco. Alinco warns that the Warranty is void if this Mod is performed! KA1BOY has been great enough to try this Mod and says it works great for 1200 baud as well as 9600 baud! From all of us to you, THANK YOU BARRY! One point to remember, you will not be able to use the radio for voice. This mod uses the Mic Connector...

#### TRANSMITTER

1. Remove R-31
  2. Remove C-40 (save this part, it is to be reused!)
  3. Connect one leg of C-40 to PIN 7 of the VCO Board
  4. Connect a jumper from the free leg of C-40 to the HOT end of C-35
- The MIC input is now connected DIRECTLY to the VCO!

#### RECEIVER

1. Disconnect the PINK wire connected to the MIC connector and the PC Board from the PC Board
  2. Reconnect the PINK wire to PIN 2 on the IF Board connector
- This eliminates the low pass filtering on the discriminator!

That is it to the MOD for the 110, 112, and the 1200! Remember, you now use the MIC Connector For inputting 9600 baud and it WILL work for 1200 baud! A special note to all SYSOPS out there...Buy this radio and do this MOD! It will allow users to set their TXDelay down to a lower setting giving the channel MORE throughput! USERS, make a DONATION to your SYSOPS so they can help make the system YOU are using, BETTER! We must all do our part to help!

I would like to hear from all of you that tries this MOD!

I GIVE PARTIAL CREDIT TO BARRY, KA1BOY, FOR HIS INPUT ON THIS MODIFICATION!!!  
73 FELLOW PACKETEERS!!! DINO...KC6RIX @ WF6O.#SOCA.CA.USA.NA

=====  
Note: I haven't tried or verified this, proceed at your own risk. WA2ISE

Article 3528 of rec.radio.amateur.packet:  
Newsgroups: rec.radio.amateur.packet  
Path: west.West.Sun.COM!sun-barr!ames!agate!stanford.edu!morrow.stanford.edu!  
pst  
From: pst@cisco.com (Paul Traina)  
#Subject: Re: 9600 baud mod for Alinco 110, 112, 1200 radios  
In-Reply-To: wa2ise@cbnewsb.cb.att.com's message of Sun, 26 Jul 1992 04: 35:34  
GMT  
Message-ID: <PST.92Jul26125156@lager.cisco.com>  
Sender: news@morrow.stanford.edu (News Service)  
Organization: cisco Systems, Menlo Park, California  
References: <1992Jul26.043534.23205@cbfsb.cb.att.com>  
Date: Sun, 26 Jul 1992 20:51:55 GMT  
Lines: 20

I have made this mod, and I have the following suggestions:

- (a) you can get a "map" of the board via FAX or snail mail from Alinco  
-- this helps a LOT (it's impossible to read component labels) --  
Alinco is in Torrance Calif, in the phone directory.
- (b) Throw away C40, it is impossible for a mere mortal to do what they  
are suggesting. Replace that SMT C40 with an axial .01uf cap  
(non-polarized, anything kind you want, I used a tant.) and some  
insulation tubing over the leads (it needs to stretch 2 inches  
across the bottom of the pcb.

Alinco claims this mod makes 1200bps unusable, untrue, I use my modded  
1200 on both 1200 and 9600 bps without noticable degredation of  
performance.

Regards,

Paul

--

% lookup ampallang

Word: "ampallang"

Suggestions: 1 employing 2 impaling 3 impelling 4 implying



From: 72277.550@CompuServe.COM (Bob Ross)  
Newsgroups: rec.radio.amateur.packet  
Subject: MFJ - ALINCO & 9600  
Date: 1 Feb 93 04:32:22 GMT  
Organization: UCSD Usenet Gateway  
Lines: 32  
Message-ID: <930201043222\_72277.550\_DHJ69-1@CompuServe.COM>  
NNTP-Posting-Host: ucsd.edu  
Originator: daemon@ucsd.edu

Hello Angelo...

>> I am using the MFj-1270B with the MFJ G3RUH modem with my Alinco 1200 data  
>>radio to connect to a Cluster high speed backbone network.. It works great  
>>for me.. I am wondering the mod that Alinco suggested to you?? There were  
>>several of them.

The Mod was as follows:

#### TRANSMITTER

1. Remove R-31
2. Remove C-40 (save this part, it is to be reused!)
3. Connect one leg of C-40 to PIN 7 of the VCO Board
4. Connect a jumper from the free leg of C-40 to the HOT end of C-35  
The MIC input is now connected DIRECTLY to the VCO!

#### RECEIVER

1. Disconnect the PINK wire connected to the MIC connector and the PC Board  
from the PC Board
2. Reconnect the PINK wire to PIN 2 on the IF Board connector  
This eliminates the low pass filtering on the discriminator!

I am real happy to hear that at least one mfj & alinco works.. Is this the  
mod  
you used???

Thanks Bob Ross n2oml  
internet - 72277.550@compuserve.com



Newsgroups: rec.radio.amateur.misc  
Path: elroy.jpl.nasa.gov!decwrl!csus.edu!netcom.com!wa2ise  
From: wa2ise@netcom.com (Robert Casey)  
Subject: DR1200 InterMOD reduction mod file  
Message-ID: <wa2iseC69xqL.3xs@netcom.com>  
Keywords: intermod  
Organization: NETCOM On-line Communication Services (408 241-9760 guest)  
Date: Fri, 30 Apr 1993 02:03:57 GMT  
Lines: 40

copied from packet:

```
Msg# TSF  Size  Date  Time  Arrived #Rd  Seq #      Msg ID      Route
  612 BF   2607 21-Apr 1643z 24-Apr   0 (002799 - 28806_W0LJF ) []
K0ZL ==> MODS@USBBS
"DR-1200 INTERMOD REDUCED"
```

#### ALINCO DR-1200 INTERMOD REDUCTION

CAUTION: THE FOLLOWING PROCEDURE INVOLVES DESOLDERING SMD (SURFACE MOUNT DEVICES). IF YOU ARE NOT QUALIFIED TO WORK ON SMD DEVICES OR DO NOT HAVE THE PROPER EQUIPMENT, DO NOT ATTEMPT THIS MOD! SEEK PROFESSIONAL TECHNICAL ASSISTANCE. THE ORIGINATOR OF THIS MODIFICATION IS NOT RESPONSIBLE FOR ANY LOSS INVOLVING THE PERFORMANCE OF THIS MODIFICATION.

CAUTION: THIS RADIO EMPLOYS STATIC SENSITIVE DEVICES. SUITABLE MEANS SHOULD BE EMPLOYED TO ASSURE A STATIC-FREE ENVIRONMENT PRIOR TO BEGINNING WORK ON THIS RADIO.

1. REMOVE POWER AND ANTENNA FROM RIG
2. REMOVE BOTTOM COVER
3. LOCATE C-19, LEFT SIDE FRONT OF BOARD (CLEARLY LABELED, NEAR Q3).
4. REMOVE C-19: SUCK UP THE SOLDER AND CAREFULLY PRY AWAY FROM BOARD WHILE STILL WARM.
5. SAVE THE CAPACITOR IN CASE YOU GOT THE WRONG PART!
6. REASSEMBLE THE RADIO, NO RETUNING NECESSARY.

This capacitor connects D1 (back to back diodes) to the first IF line. D1 is supposed to be a "limiter". Unknown why Alinco chose to put in such a limiter, as the integrated IF chip IC-1, an MC3357, has a built-in limiter. Also, the Kenwood TM-231 which uses nearly the same layout and circuit, doesn't have such a circuit.

While the intermod hasn't gone away entirely (I'm not done with it yet!), it has diminished enough to make the rig usable on packet AND voice now.

73 de Bill, K0ZL@W0LJF.#NECO.CO.NOAM

=====

=

Note: I haven't tried or verified this. proceed at your own risk. WA2ISE





Newsgroups: rec.radio.amateur.misc  
From: wa2ise@cbnewsb.cb.att.com (robert.f.casey)  
Subject: Alinco DR1200t full band mod file  
Message-ID: <1992Oct4.161109.13943@cbfsb.cb.att.com>  
Keywords: mods  
Sender: news@cbfsb.cb.att.com  
Organization: AT&T  
Date: Sun, 4 Oct 1992 16:11:09 GMT  
Lines: 30

copied from packet:

| Msg#                            | TSF | Size | #Rd | Date   | Time  | Arrived | Seq #                   | Msg ID | Route |
|---------------------------------|-----|------|-----|--------|-------|---------|-------------------------|--------|-------|
| 1020                            | BF  | 1405 | 0   | 22-Sep | 2223z | 29-Sep  | (033727 - 26390_KB2NEX) | []     |       |
| N2ROC ==> ALL@USBBS             |     |      |     |        |       |         |                         |        |       |
| "ALINCO FULL BAND MODIFICATION" |     |      |     |        |       |         |                         |        |       |

#### Alinco DR1200T Full Band Modification

- Step 1. Remove 2 screws located on top of cover.
- Step 2. Loosen the 4 screws on both sides of top cover (do not remove).
- Step 3. Remove top cover
- Step 4. Locate Yellow wire Loop behind tuning Knob (this wire loops from the control board mounted on front panel).
- Step 5. Cut loop and tape ends.
- Step 6. Replace top cover.
- Step 7. Reset radio (press 'F' and VCO/M keys together. While holding down keys turn off and on Power).

Factory settings will be restored however the new frequency range will be from 132 to 173 MHz. Any memory will have to be reprogramed. These insructions are from Alinco, I've done them to my set and it works great.

\*\*\* END OF MSG # 26320 from N2ROC @ KB2NEX.#NYC.NY.USA.NA

=====

Note: I haven't tried or verified this, proceed at your own risk. WA2ISE

-----

Newsgroups: rec.radio.amateur.misc  
From: kdlhz@anomaly.sbs.risc.net (Michael P. Deignan)  
#Subject: Re: Alinco DR1200t full band mod file  
Organization: The Rhode Island Internet Systems Cooperative Network  
Date: Sun, 04 Oct 1992 20:03:05 GMT  
Message-ID: <1992Oct04.200305.9906@anomaly.sbs.risc.net>  
References: <1992Oct4.161109.13943@cbfsb.cb.att.com>  
Keywords: mods  
Lines: 18

wa2ise@cbnewsb.cb.att.com (robert.f.casey) writes:

> Alinco DR1200T Full Band Modification

This modification also works on the DR112 and DR110 radios. Frequency range

when applied:

130.000 - 169.995

340.000 - 379.995

870.000 - 889.995

MD



Newsgroups: rec.radio.amateur.misc  
From: wa2ise@netcom.com (Robert Casey)  
Subject: DR130 MARS mod file  
Message-ID: <wa2iseC74yos.Dq1@netcom.com>  
Keywords: mods  
Organization: NETCOM On-line Communication Services (408 241-9760 guest)  
Date: Sun, 16 May 1993 20:10:03 GMT  
Lines: 21

copied from packet:

Path: N6IIU!N6QMY!N6IYA!WA7SJM!WA7BHH!W7GCI!W7GCI!W0RA ...

Here is the expanded TX mod for the Alinco DR-130:

1. Open the top of the case by removing the three screws.
2. Locate the blue loop of wire near the display, facing toward you.
3. cut the blue loop of wire, and tape up the ends.
4. replace cover of the radio.
5. reset the radio by holding the function key down and turning on the power.

Here is also a cute little mod for the display:

Insted of seeing frequency display (147.585 etc.) You can have it read out like a business band radio (CH-1) by holding the VFO/M/W key and turning on the power.

-73- De Greg, N8PPZ

=====

=  
Note: I haven't tried or verified this, proceed at your own risk. WA2ISE

-----

-  
ex AT&T Bell Lab Member Technical Staff, currently a Sprint customer!



Date: 7 Jul 90 04:22:14 GMT  
 From: philmtl!philabs!briar!rfc@uunet.uu.net (Robert Casey)  
 Subject: Alinco DR510 Crossband Repeater Mod  
 To: info-hams@ucsd.edu

copied from packet:

```

Msg# TSF  Size #Rd  Date  Time From  MsgID      To
29789 BF   4806   0 24-Jun 0021 N8KNJ  2111_KA3T  MODS@NYNET ()
  Sb: Alinco DR-510 Cross-Band Rpt MOD
  
```

DR-510 - Vehicular Extender Modification

I discovered this modification the other day and wish to share it with other 510 owners, I did it and it works for me!

I did not originate the modification and will NOT accept any responsibility for any damage the may occur as a result. (I won't myself. WA2ISE)

How to do it

1. Remove bottom cover
2. Remove 2 Phillips screws at corners of subtone board (small board near center in front) and move the tone board out of the way.
3. Solder an 16V electrolytic capacitor (10MFD to 100MFD but best to use 40MFD to 50MFD) as follows:
  - A. Neg (-) lead to pin 8 on device (IC) labeled - M54959P
  - B. Pos (+) lead to pin 3, counting from left while facing front of transceiver of the white 11 pin connector.

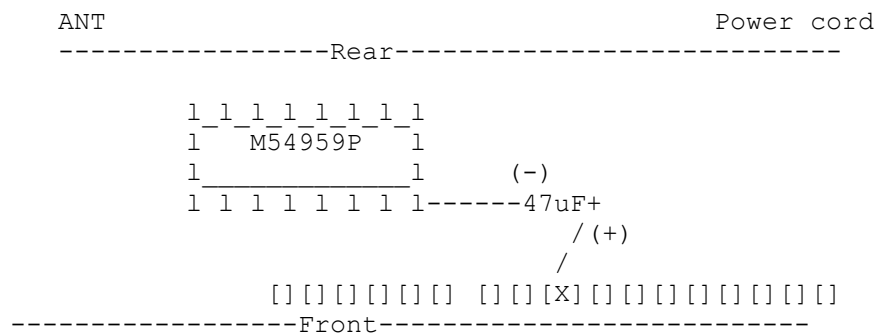

4. Remove top cover and faceplate of transceiver. Be careful of speaker wires!
  - A. To remove faceplate:
    1. Remove main dial knob and retaining nut.
    2. Remove mic. socket retaining ring.
    3. GENTLY lift tabs, located approximately 3/4" in from each side, on top of faceplate and "rotate" toward front of the transceiver.
    4. When tabs are "free", turn transceiver over and repeat the process. Remember - gently!

5. Set free plate aside.

5. Locate surface mounted device labeled R-35 on control board (front of transceiver).

A. R-35 is positioned between, and slightly below, the squelch and high/low power button. To the left of device R-35 is a "circle" trace. Inside the "circle" trace are two solder pads, one of which is already soldered to R-35.

6. Bridge the unsoldered pad to the soldered pad inside the "circle" trace.

7. Short R-35

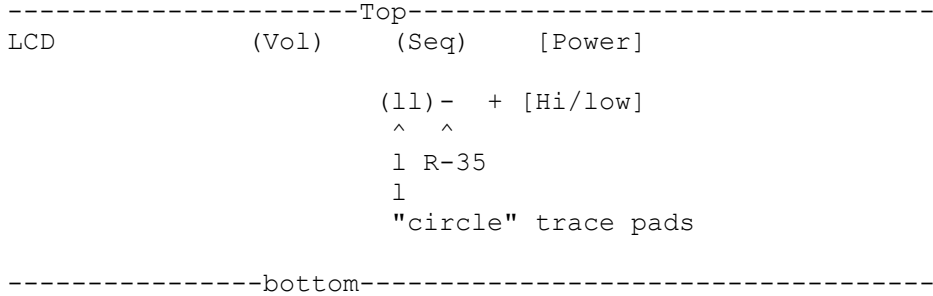

8. Replace faceplate, retaining nut, retaining ring, tone board, bottom and top of transceiver.

Operation

1. Store different bands (2m or UHF) in VFO mode and Memory Channel 1-9. Any thing you can store in memory 1-9, split, subtone enc, subtone dec will work.
2. Store "DUAL" mode in VFO (Simplex) also it will accept subtone enc and subtone dec.
3. Turn power off and then keep pressing the REV key, turn on the power switch.
4. Audio Vol. control is your deviation control in repeater mode.
5. To return to normal operation turn off power then turn on again without pressing any keys.

Notes:

The transceiver scans back and forth between the VFO and Memory until it finds a signal then it locks on and transmits what it hears on the other band. This scanning causes a slight delay when keying up as the radio takes time to scan. I recommend the use of subtones when possible so that the radio will not key up on noise and not allow non-authorized personal to use your radio, the transmissions of which YOU are responsible.

Good Luck, es 73's Rick N8KNJ

Note: I haven't tried this, proceed at your own risk. WA2ISE

-----





Article: 26378 of rec.radio.amateur.misc  
From: kdj@iinus1.ibm.com (Ken Johnson)  
Newsgroups: rec.radio.amateur.misc  
Subject: DR570 MODS  
Date: 12 Oct 1992 19:16:49 -0700  
Organization: UCSD Usenet Gateway  
Lines: 12  
Sender: daemon@ucsd.edu (The Devil Himself)  
Message-ID: <9210130216.AA13971@ucsd.edu>  
NNTP-Posting-Host: ucsd.edu

Paul; et al; Here's how to get to the 850 band on a modified 570:

1. make sure the 2M side of the radio is in VFO mode...
2. push <BAND> to make 2M the sub-band (440 side is the main band)
3. push <FUNC> <BAND>... "SUB" indicator should come on...
4. push <BAND>... should see some 350.xxx freq. in the sub-band.
5. push <BAND>... should see some 850.xxx freq. in the sub-band.
6. push <FUNC> <BAND>... back to "normal" radio mode...
7. push <BAND> to switch the 850.xxx band to the main band where you can play with it..

Ken. KC4YOZ



From: wa2ise@cbnewsb.cb.att.com (robert.f.casey)  
Newsgroups: rec.radio.amateur.misc  
Subject: DR599t extended RX mod file  
Keywords: mods  
Message-ID: <1992Mar1.195256.18027@cbfsb.att.com>  
Date: 1 Mar 92 19:52:56 GMT  
Sender: news@cbfsb.att.com  
Organization: AT&T Bell Laboratories  
Lines: 30

copied from packet:

| Msg#  | TSF | Size | #Rd | Date   | Time | From  | MsgID      | To         |
|-------|-----|------|-----|--------|------|-------|------------|------------|
| 18491 | BF  | 1577 | 2   | 29-Feb | 2230 | KB3ZS | 634_WA3NWL | ALL@EPA () |

Sb: alinco dr599t owners

Hello out there dr599t owners.  
Have some interesting info about the rig. If you take off the removeable front panel and remove the two phillips screws holding the front panel together, you will find two junper wires (one red, the other blue). Cut both jumpers and reset (funct + power). Remember to write down all your memories. You will find that the radio will recieve on 108.00 to 142.990 AM on the vhf side and 850.000 to 909.9875 on the uhf side. To activate the (EXTRA OPTIONS), just press the VHF and also the UHF BAND buttons twice. With each press, you will activate either the normal or the EXPANDED band capabilities of the radio. It's nice when a Ham creates a rig to do things for other Hams. Look Ma, no special wiring or soldering to do. just cut some jumpers and away you go. Just remember, no transmitter operations on frequencies you are not allowed! For the complete file, check into the Langhorne Connection BBS via 2400 or less via phone line. Other Ham information is available on this BBS. The number to call is 215-322-2133 weekday evenings 6pm to 6am (local) and all weekend long. Also, come and get your copy of the Michelangelo Virus scanner/protector available on The Langhorne Connection.

=====  
Note: I haven't tried or verified this, proceed at your own risk. And Do Not transmit outside of legal bands! WA2ISE



Subject: DR600 Mod

Hi,

I just got the info on how to modify the Alinco DR-600. I have activated these mods and they seem to work fine. Here they are:

Mod 1 - Activate 108 - 142 MHz and 810 - 998 MHz Receive  
-----

Remove head unit from radio and open it up.

Inside you will see a red and blue wire.

Cut the red wire.

Open the main unit and attach a wire to CN-205. This will be your antenna for 810-998 MHz.

Close everything up.

Reset the CPU by holding down the FUNC key while you turn the radio on.

To use:

The VHF key toggles between 108-142 and 2m. This toggle only works in VFO mode.

The UHF key toggles between 810-998 and 70cm. This toggle only works in VFO mode.

Mod 2 - Extended tx/rx on 2m and 70cm  
-----

Remove head unit from radio and open it. (2 screws on back)

Inside you will see a red and a blue wire.

Cut the blue wire.

Put everything back together.

Reset the CPU by holding down the FUNC key while you turn the radio on.

You can now transmit and receive on the following freqs:  
130-174MHz and 400-517MHz

Be carefull!!!!!! You can now transmit outside of the HAM bands. Don't do this! If you do you WILL get caught and the FCC loves those \$10,000 fines.

NOTE: I take no responsibility for these modifications. If you blow up your radio it is not my fault. If you have any questions about these mods call Alinco.

Chris Levin  
levin@cosmic.physics.utah.edu





Article: 19525 of rec.radio.shortwave  
Path: news.cs.tut.fi!news.funet.fi!sunic!uunet!zaphod.mps.ohio-state.edu!  
magnus.acs.ohio-state.edu!cis.ohio-state.edu!rutgers!twells!pics!bill.kelsey  
From: bill.kelsey%pics@twells.com (Bill Kelsey)  
Newsgroups: rec.radio.shortwave  
Subject: DX440 mod  
Message-ID: <1568.372.uupcb@twells.com>  
Date: 10 Apr 93 14:18:00 GMT  
Reply-To: bill.kelsey%pics@twells.com (Bill Kelsey)  
Organization: Pics OnLine! MultiUser System - 609-753-2540  
Lines: 183

From: ouyang@yoko.rutgers.edu (Ming Ouyang)  
Date: 24 Mar 93 04:30:36 GMT

--> Quoting Ming Ouyang to All <==

MO> The Sangean ats803a has a "rec out". But on my DX440, after I removed  
MO> the little piece of plastic which covered the supposed position of the  
MO> jack, I found no jack at all. I guess I have to hardwire one. So is  
MO> there any mod plan of doing this? I'd like to use DX440 as a tuner in  
MO> a stereo system. Thanks in advance.

MO> I am sorry if this had been asked recently. I didn't read this  
MO> newsgroup in the past few months.

MO> -- Ming Ouyang  
MO> ouyang@paul.rutgers.edu

Here is a pretty complete description of adding the DIN plug to a  
DX-440, garnered from various (identified) sources. Note that you  
probably will \*not\* be able to use the signal from the DIN plug with  
your stereo, unless your stereo accepts direct microphone input, since  
the TAPE OUT on the DX-440 is intended to connect to a MIC IN jack.  
You might do better to simply run a stereo patch cord from the DX-440  
HEADPHONE jack to the stereo's TUNER or AUX jack.

#### A GENERAL DESCRIPTION OF THE WORK

From: Michael Mitchell:  
OK, Here's some stuff from the boards that I've picked up on  
modifying the DX440 to have the tape-out as the radio was  
originally designed before RS got their marketing guys on it.  
Check out the plug in the case where the DIN connector goes. I  
have the DX440 and just installed the five pin DIN connector on  
the PCB just as it must have been intended. The only thing you  
need to do is desolder the holes on the PCB and install a 5 pin  
DIN PCB mounted connector. Everything fits in place and you now  
have record output.... Once I had the DIN installed and placed  
the cover on, you could not tell it from a factory job... If you  
have a Radio Shack nearby, just order a PCB Mounted DIN Connector  
for a Radio Shack Color Computer Cassette Interface Port. It's  
the same thing that worked for me.

The Pinouts for the DX-440 Record-Out Project.

```

Locating Hole -[]
  5 N.C.  - 0          0 - Audio Left 6
  3 N.C.  - 0          0 - Audio Right 4
    Ground --- 0
                2

```

This diagram is looking at the face of the receptacle after installation. BTW.. This makes a very tidy installation. You cannot even tell it was installed by anyone but the factory. The standard DIN connector fits up flush with the case. Mind you that the output is LOW LEVEL. That is to say on the order of 15 to 20 Millivolts (.015 Volts A.C.). One person previously was trying to measure with a DC setting which doesn't work very well. This connection drives a microphone input very well. It is independent of the volume control which is nice for late night recording, and it will put out FM stereo when the stereo - mono switch is set for stereo.

#### A MORE DETAILED DESCRIPTION OF THE WORK

From: William N. Abbay:

Installing the DIN jack is very easy. The PC board is already drilled and prepared for a standard jack. Find a PC board mount jack, and you cannot go wrong. I'll go through the whole procedure, just in case you haven't had a chance to explore the insides of your radio.

Lay the radio on its face, right side up. From the back of your radio, there are 6 phillips screws holding it together. They are approximately in this pattern:

```

      o           o           o

```

```

This one ---> o           o           o
is inside
the battery
compartment

```

Remove all the screws. Remove the large D batteries, if any. You can leave the AA batteries.

Lift the cover but be careful of the antenna wire which connects the whip antenna to the radio PC board. Turn the back over and set it above the radio.

Look inside, now. On the right side of the radio compartment, you will see a smaller PC board mounted above the main board. This is the audio board. Near the top center and lower left corner, see the black plastic mounting clips. They support the board. Look closely and you will see that the board can be lifted carefully off these clips. Before you do this, notice the three solder pads near the lower left side. These contact the three fingers sticking out of the battery compartment to provide

battery power to the radio. Those three fingers must make good contact or the radio's computer will misbehave and act goofy.

Gently pry the clips and lift the board. There are wires which connect to board to the speaker. Be careful of these. If they are secured with a plastic tie, cut the tie [NOT the wires. :-)] This will give you some extra room. If you are very careful, you can maneuver the board over on its back and see the pattern of holes next to the earphone jack. These are exactly the right pattern for a standard PC board-mount DIN jack. Hold your jack next to the holes and you can see which ones I mean.

At the factory, the soldering of the board probably covered these holes. You will have to clear them out. From the back, using a small, low wattage soldering iron, heat the solder around these holes and stick a round tooth-pick through from the top. If you have a "solder sucker" or other de-soldering tool, the job will be easier. You must completely free these holes of solder. When this is done, you are ready to install your jack. It can't go in but one way. Insert the jack and, using fresh solder, solder each legs to its pad ... be careful and don't use too much.

Remove the plug which covers the hole in the case.

Reassembling your radio is just the reverse of the above. Carefully line up the jacks with the holes in the case at the same time you line up the clips which fit through the holes in the PC board. Snap the audio board into place. Lift the back over and onto the radio, taking care that you don't leave the antenna wire sticking outside the case. You have rock the back slightly to get it to seat, sometimes. Don't force anything. The screws are all the same.

If your radio acts goofy when you are done, it is probably due to the fact that the micro processor has not initialized properly when you connected the case back up. The small AA batteries power the microprocessor when all other power is removed. In this case, however, you removed all power from the radio when you disconnected the case. Simply remove the AA batteries for a few minutes, and reinsert. Everything should be ok.

As to which contact goes where: I have only identified the two audio pins. When I get time to run down what the others do, I will post it to Genie. Looking toward the jack from the outside of the radio, the "x"s mark the audio out pins.

|   |   |   |                                 |
|---|---|---|---------------------------------|
|   | x |   | I connected these directly to   |
| x |   | o | the microphone input on my tape |
|   |   |   | recorder and it works just      |
| o |   | o | fine as a constant level input. |

[]

Now, you can do a favor for me! Somewhere in the process of doing this to mine, I have disconnected a small green wire. I cannot find out where it goes but the radio works without it. Right now it is just loose. It seems to have gone somewhere on

the audio board, but I cannot be sure. When you go inside your radio, perhaps you can reply back as to where that little green wire goes?

THE RADIO SHACK DIN PLUG

From: Fred Mckenzie:

To get the special pcb-mount 5-pin DIN connector, order from Radio Shack a "Cassette I/O Jack" (JK4) for a TRS-80 Color Computer model 2 or 3. The Radio Shack part number is AJ-7356, although the bag mine came in was marked JE-1216. The price was \$1.00. If they don't know already, the Radio Shack Color Computer 3 is catalog number 26-3334.

[message continued]

... E'n la sua volontade . nostra pace. (Dante Alighieri)  
\_\_\_ Blue Wave/QWK v2.12

-----

```
+-----+
| Pics OnLine MultiUser System   (609)753-2540 HST   609-753-1549 (V32) |
| Massive File Collection - Over 45,000 Files OnLine - 250 Newsgroups   |
+-----+
```

Article: 19528 of rec.radio.shortwave

Path: news.cs.tut.fi!news.funet.fi!sunic!uunet!gatech!concert!rutgers!twells!  
pics!bill.kelsey

From: bill.kelsey%pics@twells.com (Bill Kelsey)

Newsgroups: rec.radio.shortwave

#Subject: DX440 mod

Message-ID: <1571.372.uupcb@twells.com>

Date: 10 Apr 93 14:21:00 GMT

Reply-To: bill.kelsey%pics@twells.com (Bill Kelsey)

Organization: Pics OnLine! MultiUser System - 609-753-2540

Lines: 140

From: ouyang@yoko.rutgers.edu (Ming Ouyang)

Date: 24 Mar 93 04:30:36 GMT

-=> Quoting Ming Ouyang to All <=-

MO> The Sangean ats803a has a "rec out". But on my DX440, after I removed  
MO> the little piece of plastic which covered the supposed position of the  
MO> jack, I found no jack at all. I guess I have to hardwire one. So is  
MO> there any mod plan of doing this? I'd like to use DX440 as a tuner in  
MO> a stereo system. Thanks in advance.

MO> -- Ming Ouyang

MO> ouyang@paul.rutgers.edu

[continued -- 2]

THE RADIO SHACK DIN PLUG

From: Fred Mckenzie:

To get the special pcb-mount 5-pin DIN connector, order from Radio Shack a "Cassette I/O Jack" (JK4) for a TRS-80 Color Computer model 2 or 3. The Radio Shack part number is AJ-7356, although the bag mine came in was marked JE-1216. The price was \$1.00. If they don't know already, the Radio Shack Color Computer 3 is catalog number 26-3334.

#### THE DIN CONNECTING CABLE

From: Bill Kelsey:

Now that we've had several messages explaining exactly how to install the missing DIN plug into the Radio Shack DX-440 version of the Sangean ATS-803A, the next problem (for owners of either the ATS-803A or DX-440) is how to connect that DIN connector to the microphone inputs on your tape recorder. Note that connecting the DIN plug to LINE IN/TAPE IN jacks on a receiver or tape recorder won't work; the DIN connection only works with a low level microphone input (most mic inputs are low level).

You can buy a DIN => 1/8" miniplug monophonic connecting cable from UNIVERSAL RADIO (1-800-431-3939): it's the "ATS-803 CBL", order #1687, and sells for \$14.95 (+\$2 s&h). The example I have is 3 feet of RG 58 A/U foam cable connected between the right channel output of the DIN plug and a 1/8" mono mini plug. Cost of the parts (unassembled) from Universal is \$3.19 (mini plug, #0707, \$ .69 [Radio Shack: #274-286, \$1.49 (pkg of 2)]; 5 Pin DIN plug, #1828, \$1.99 [Radio Shack: #274-003, \$1.69]; RG-58 A/U 50 Ohm foam cable, #2619, \$ .17/ft [Radio Shack: #278-1314, \$ .20/ft]).

According to their catalogue, Universal will also custom build this for the cost of the parts and \$10 (ask for the Special Order Custom Cable, #0569), plus \$2.50 s&h.

This works OK, so long as you're happy with a one channel mono connection. However, it is just as easy (and less expensive) to build a stereo cable. (Note that if you install a stereo plug, you may need to use a stereo => mono adapter when running into a mono recorder; Radio Shack has these). There are two approaches to this (all part #'s and prices from the 1992 Radio Shack catalog, #472):

#### APPROACH #1 (MODIFYING A DIN - DIN CABLE)

parts:

- 1: a 6-ft shielded DIN - DIN cable (Radio Shack #42-2151; \$4.99)
- 2: an appropriate stereo plug, such as a stereo mini-plug (either #274-284, \$2.19/pkg of 2; or #274-1547, \$1.99 (the latter is metal and shielded); other sizes of plugs can also be used, depending on your tape recorder microphone jacks); alternatively, LEFT and RIGHT mono plugs, such as red and black mini plugs (RED: #274-287; BLACK: #274-286; both \$1.49/pkg of 2) may be used

Clip one end off the DIN - DIN cable, and attach the stereo plug to the GROUND, LEFT, and RIGHT wires. On my cable, the RED wire is RIGHT CHANNEL OUT and the WHITE wire is LEFT CHANNEL OUT. The

YELLOW and BLACK wires (LEFT and RIGHT INPUT, respectively) are ignored. On a stereo plug, the tip of the shaft is the LEFT channel, the middle section is the RIGHT channel, and the back section is the GROUND. You should be able to identify the connections from this -- if not, when attaching the cable, the LEFT channel will be the connection going to the center, the GROUND the connection sticking out the back that extends to the threaded part of the plug, and the RIGHT channel the connection between the LEFT channel and the GROUND.

If LEFT and RIGHT mono plugs are used, the LEFT or RIGHT connection is to the center of the plug, while the GROUND is to the outside.

TOTAL COST: about \$7

APPROACH #2 (BUILDING A CABLE FROM SCRATCH)

parts:

- 1: 5-pin DIN plug (#274-003, \$1.69)
- 2: an appropriate stereo plug or mono plugs, as above
- 3: shielded audio cable, such as #278-514 (20 ft, 2 conductor, \$3.49) or #278-777 (30 ft, 4 conductor, \$7.95)

On the Sangean ATS-803A the DIN jack looks like this (I suppose it looks the same on the modified DX-440), FACING THE DIN JACK:

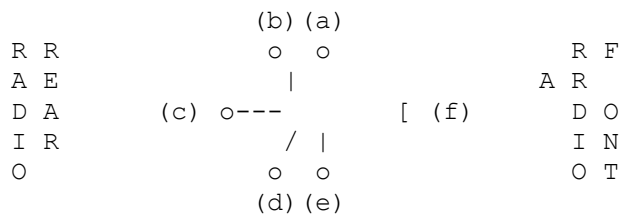

- |                               |                   |
|-------------------------------|-------------------|
| a = left input (unconnected)  | d = right output  |
| b = right input (unconnected) | e = left output   |
| c = ground                    | f = locating hole |

The DIN plug connections, then, must be exactly the same, FACING THE BACK (WIRE SIDE) OF THE DIN PLUG. Attach the stereo plug, or LEFT and RIGHT mono plugs, as above.

TOTAL COST: about \$7

One last note on taping from the ATS-803A/DX440: I don't believe this radio can activate a tape recorder's remote control, but by using the radio's timer in conjunction with a voice activated tape recorder you can achieve the same effect. I use a Radio Shack Minisette-20, and it works like a charm (although having an auto-reverse recorder would be nicer)!

BTW, I've also discovered that you can play tapes back through the ATS-803A by moving the plugs from the MIC IN jack to the HEADPHONE jack on the cassette recorder. All of the SW receiver's amplifier controls (volume, balance, bass, treble) work. Coupled with a set of small AC/battery powered self-amplified speakers, this has given me a portable LW/MW/SW/FM/cassette stereo system I can easily take on extended trips.

... Nam risu inepto res ineptior nulla est! (Catullus)  
\_\_\_ Blue Wave/QWK v2.12

----

```
+-----+  
| Pics OnLine MultiUser System   (609)753-2540 HST   609-753-1549 (V32) |  
| Massive File Collection - Over 45,000 Files OnLine - 250 Newsgroups   |  
+-----+
```





From news.cs.tut.fi!butler.cc.tut.fi!fuug!mcsun!uunet!usc!elroy.jpl.nasa.gov!  
ames!titan.ksc.nasa.gov!k4dii.ksc.nasa.gov!user Sun Mar 28 15:19:44 EET DST  
1993

Article: 19216 of rec.radio.shortwave

Path: news.cs.tut.fi!butler.cc.tut.fi!fuug!mcsun!uunet!usc!elroy.jpl.nasa.gov!  
ames!titan.ksc.nasa.gov!k4dii.ksc.nasa.gov!user

Newsgroups: rec.radio.shortwave

Subject: Re: DX440 mod

Message-ID: <fred-mckenzie-260393130913@k4dii.ksc.nasa.gov>

From: fred-mckenzie@ksc.nasa.gov (Fred McKenzie)

Date: 26 Mar 93 13:22:50 EST

Followup-To: rec.radio.shortwave

References: <Mar.23.23.30.35.1993.25624@yoko.rutgers.edu>

Distribution: world

Organization: NASA/Kennedy Space Center, Florida

Nntp-Posting-Host: k4dii.ksc.nasa.gov

Lines: 29

In article <Mar.23.23.30.35.1993.25624@yoko.rutgers.edu>,  
ouyang@yoko.rutgers.edu (Ming Ouyang) wrote:

> The Sangean ats803a has a "rec out". But on my DX440, after I removed  
> the little piece of plastic which covered the supposed position of the  
> jack, I found no jack at all. I guess I have to hardwire one. So is  
> there any mod plan of doing this? I'd like to use DX440 as a tuner in  
> a stereo system. Thanks in advance.

Ming-

There is a place for the "rec out" connector, just inside the hole covered  
by the little piece of plastic. Order a "cassette jack" for the Radio  
Shack Color Computer, from Radio Shack parts department. You may have  
other sources for this PCB mounted, 5 pin DIN connector, since it is fairly  
common.

Before attempting to mount the connector, you may have to clean any excess  
solder out of the holes on the PCB. It's a tight fit, so be sure the  
connector is seated all the way. If you're successful, it will look like a  
factory job when you're through!

Of the 5 pins, the center one is signal ground. Two pins on one side of  
center, are connected via resistors to ground. The two pins on the other  
side go to low level, left and right stereo signals. They are fed from  
voltage-dividing resistors, so short-circuiting them will not hurt  
anything. The signal level is just right for many tape recorder microphone  
inputs, and is not affected by the DX-440 volume control setting.

fred-mckenzie@ksc.nasa.gov



Article 16170 of rec.radio.amateur.misc:  
Path: west.West.Sun.COM!sun-barr!olivea!gossip.pyramid.com!uunet!ftpbox!  
news.acns.nwu.edu!interpol  
From: interpol@casbah.acns.nwu.edu (Interpol)  
Newsgroups: rec.radio.shortwave,rec.radio.amateur.misc  
Subject: Sangean ATS803A/Realistic DX-440 Radio Modification  
Message-ID: <1992Mar25.180106.3764@casbah.acns.nwu.edu>  
Date: 25 Mar 92 18:01:06 GMT  
Sender: interpol@nwu.edu  
Organization: Northwestern University, Evanston, Illinois  
Lines: 40  
Xref: west.West.Sun.COM rec.radio.shortwave:15087 rec.radio.amateur.misc:16170

Here's an interesting mod I found on CompuServe:

#### ATS-803A and DX-440 Mod

This mod gets rid of the "chuff" when tuning the radio that becomes very annoying. This Mod also enables the speaker while you are scanning. You will be surprised on how much you have missed. I have done the mod and it is real easy. If you don't like it change it back. I got the mod from a unknown source, so it has not yet been tested. I have heard of no complaint or problems.

The Mod is so easy all you need is a Phillips screwdriver and 5min's. It's that easy. Ok here it is:

- 1) Remove the batteries from the unit and turn it upside down so the antenna is facing away from you.
- 2) Remove the six screws and remove the cover (be careful that you don't break the antenna wire)
- 3) Okay so far so good. Now locate the 8-pin cable.
- 4) Remove it carefully. Bend the second lead from the left to a 90'.
- 5) Replace the cable and make sure the lead is not touching anything.
- 6) Wa la it's done. Not so bad now huh?

Okay that's it for now. If I find any newer ones I'll make sure to pass it on.

Chris Johnson CI\$ (70674,1424)

---

|                                 |                               |  |
|---------------------------------|-------------------------------|--|
| Drew S. Cheng, BA '91 MD '95    | "Compelling, yet tedious...I  |  |
| Northwestern University         | feel spent, like a man who is |  |
| Medical School, Chicago, IL USA | forced to wear his genitals   |  |
| Internet : interpol@nwu.edu     | like a pendant."              |  |
|                                 | - Dieter, "Sprockets"         |  |

---



From: wa2ise@cbnewsb.cb.att.com (robert.f.casey)  
Newsgroups: rec.radio.amateur.misc  
Subject: FT990 and 1000 extended xmit mod file  
Keywords: mod file  
Message-ID: <1992Apr4.145318.5487@cbfsb.cb.att.com>  
Date: 4 Apr 92 14:53:18 GMT  
Sender: news@cbfsb.cb.att.com  
Organization: AT&T  
Lines: 18

copied from packet:

| Msg#                        | TSF | Size | #Rd | Date   | Time | From  | MsgID        | To         |
|-----------------------------|-----|------|-----|--------|------|-------|--------------|------------|
| 7086                        | BF  | 1241 | 0   | 28-Mar | 1106 | F6HKA | 80214_FC1MAC | MODS@WW () |
| Sb: Modification FT990-1000 |     |      |     |        |      |       |              |            |

I received a mail from AA6SQ about Extended transmitter frequency range for FT990 and FT1000

-Remove top and bottom covers. Remove top screw on each side which holds front panel to chassis. Pivot front panel down slowly. CAUTION : if you let it go, it will flop down rapidly and probably tear somethins loose. Behind the meter will be the CNTL unit. It has a metal cover about 4 \* 8 inches. Snap the cover off. Look to the top of the unit. You will see JP-3. Remove the solder connection on JP-3.

Best 73 and good traffic on HF bands . Bert fF6HKA

=====  
Note: I haven't tried or verified this, proceed at your own risk. And do not transmit outside of legal bands! WA2ISE



Date: 11 Feb 90 06:27:32 GMT  
From: philmtl!philabs!briar.philips.com!rfc@uunet.uu.net (Robert Casey)  
Subject: FT101E mods so you can use USA final tubes

copied from packet:

| Msg#  | TSF | Size | #Rd | Date/Time | MsgID       | From   | To         |
|-------|-----|------|-----|-----------|-------------|--------|------------|
| 17464 | BF  | 2446 | 1   | 0131/0304 | 44022_VE3JF | VE3OSN | MODS@NYNET |

Sb: Final Mods - Yaesu FT 101E

PACKET BID: 44022\_VE3JF

Here's an old modification that's been around for a few years. I had occasion to use it recently myself, so it may be of value to someone else I am not sure of its origin, I may have picked it out of an old QST. Anyway, it works.

73 -Bob- VE3OSN @ VE3JF

#### REPLACING FINALS IN FT101E TRANSCEIVERS

-----

There will come a time when the finals in your FT101E will need replacing. These transceivers were originally equipped with 6JS6C tubes manufactured by NEC. This tube's properties are slightly different from the 6JS6C tubes available today from American tube manufacturers. By the way, don't bother looking for tubes made by NEC. They got out of the business several years ago.

In order to use the "American" variety 6JS6's, a simple modification to the neutralization circuit must be made to the final section of the transceiver.

The modification consists of replacing the fixed value 100 pf 1000 VDC mica capacitor with a 10 pf 1000 VDC mica capacitor. This capacitor, C125, is in series with the 10 pf variable neutralizing capacitor off of the plate circuit.

If this modification has not already been completed on your rig, be sure to use a mica or silver mica of at least 1000 VDC. Do not substitute a different type, because the heat in the final compartment will change the value, and your tubes will fail prematurely. Also, be very careful to keep all leads short and in exactly the same orientation as the original capacitor.

Before reneutralizing, open the variable neutralizing capacitor all the way to minimum engagement and follow the neutralizing instructions in the manual. While dipping the plate, remember to adjust the neutralizing capacitor for equal value meter reading peaks (IC position) on both sides of the dip when tuning the "Plate" control.

2352z, 1886

Note: I haven't tried this, proceed at your own risk WA2ISE

last  
@KD6TH-4  
MailBox>







Date: 2 Jun 89 16:07:14 GMT  
From: pasteur!navajo.berkeley.edu!bilbo@ucbvax.Berkeley.EDU (Bill Baringer)  
Subject: FT-209RH mods resolved

Some time ago I had tried the FT-209 mods as published in the Dec. '87 73 magazine. It hadn't worked correctly, and someone on the net verified that the jumpers listed weren't correct, but they'd forgotten the correct jumpers. Well I finally got around to doing the mod, and here are the results.

The magazine article says to jump pins 1, 7, 9, 10, 11, 13, and 16. In every 209RH I've opened, pins 1, 9, and 13 are already jumped. Adding jumpers 7, 10, 11 and 16 allows "out-of-band" transmission. But the receiver becomes thoroughly confused, and is not tunable. The solution: DON'T jump 11 and 16.

So the final steps are:

- 1) Add jumpers to 7 and 10.
- 2) Give the VCO can a 1/2 turn clockwise if you're moving to higher freqs.
- 3) Reset radio and reprogram rcv and xmit freqs, and rptr offset.

Hope this helps!

Bill           -KI6DG

All the usual disclaimers apply.



Date: Wed, 13 Sep 89 17:02:09 BST  
From: J.Heaton%manchester-computing-centre.ac.uk@NSFnet-Relay.AC.UK  
Subject: FT212 mods  
From: SV0DR@PI8EAE  
To: YAESU@EU

FT 212RH extended freq. coverage mod.

Remove the bottom and top covers and remove the front panel cover. You must then remove the front board by carefully unplugging it (try not to touch the lcd display). On the back of this board which is the control unit locate jumpers 1 through 12 and unsolder any that are soldered. All jumpers must be open (1-12 only). Reinstall the control unit and just turn on the radio for a few seconds. now turn it off again and remove the control unit again and solder jumpers 3, 4, 5, 11 only.

Put everything back together and apply power. The display will read 000. Push the MHz button and rotate the main dial until 132.000 reads on the display, then press D/MR once. Now press again the MHz button and rotate to 180.000 and press the D/MR again.

the radio is now programmed to operate from 132 to 180 mhz. mine has tx and rx through the entire spectrum with excellent sensitivity from 136 to 178. Dont forget that transmitting outside the amateur band is not allowed so please consult your local athorities for a special permit.

73s and have fun.....de SV0DR @ SV1IW

John Heaton



From: wa2ise@cbnewsb.cb.att.com (robert.f.casey)  
Newsgroups: rec.radio.amateur.misc  
Subject: FT23, 33, 73 extended range mods  
Keywords: mods  
Message-ID: <1991Dec1.030953.26190@cbfsb.att.com>  
Date: 1 Dec 91 03:09:53 GMT  
Sender: news@cbfsb.att.com  
Organization: AT&T Bell Laboratories  
Lines: 123

copied from packet:  
w2fwd.ny.usa.noam  
allbbs  
#Subject: Yaesu FT-23,33,73 Mods Revised

-----  
WARNING: Out-of-band operation is unlawful.  
This electronic document is for informational purposes only.  
Try this at your own risk.  
-----

>From the Bench of: KB2Jpd

=====

Extended Frequency Enhancements for the Yaesu FT-23R(2M), FT-33R(220),  
and FT-73R(70cm). (Revised)

=====

Greetings and hello radio amateur operators.

The topic is increasing the functional frequency coverage  
of what has been probably Yaesu's most popular handheld transceivers.

To save manufacturing costs, Yaesu engineers designed multiple  
personalities in the same CPU module found in the FT-23R, FT-33R,UHF FT-73R  
and the FT-2008/7008 transceiver. The FT-2008/7008 transceiver is the commercial  
version of the Ft-x3R series.

Unique features of this mod include

-the just say Mao feature (\*\*)  
(NO FREQUENCY READOUT: Ch 1 thru Ch 9 appear on your display.  
Great when you aren't looking and some fellow ham tries to rip  
off your simplex frequency)

-the GREAT WHOPPER  
(opens the CPU to 50-300 Mhz or 220-550 Mhz coverage. Full  
(.100 Mhz to 999.9995 Mhz) adjustable freq coverage available  
so far only on the FT-33R;this doesn't mean you can actually  
transmit but the Activity light goes in TX and you get a good  
fake RF bargraph that indicates that you can transmit on 750 MHz.  
HOW TO DO IT:

0. Contemplate invalidating your warranty. No beginners beyond this  
point. If you don't know how to solder, don't learn here. Ask  
an elmer to assist.

1. If you treasure your memories, write out your contents of your radio on a piece of paper. When you make the changes, the CPU runs a small diagnostic and see that the jumpers have been changed. It will ERASE ALL PRIOR SETTINGS.
2. Dissassemble your tranceiver.
3. Find the line of solder connections running down the CPU board. GENTLY move all wires aside so you won't melt them.
4. Using solder wick and a Good low-power soldering Iron, see chart. Read special notes for the FT-33R.
5. Rebuild radio and count your blessings.

(\*\*)NO FREQUENCY READOUT

-----  
 Removal of the solder bridge labeled number nine will activate the commercial side of the CPU module. To flip to the amateur mode, you would press F UP Arrow. To flip to the commercial mode, you would press F Down Arrow.

+++++  
 +++++ FT-23, FT-73R Chart +++++

|                      |                       |
|----------------------|-----------------------|
| 50 to 300 Mhz spread | 220 to 550 Mhz spread |
| -----                | -----                 |

Open bridges 8,9    Open bridges 7,8,9

+++++  
 +++++ FT-33R Chart +++++

Same chart as above, but I wanted to add my experience of the Yaesu FT-33R 220 Mhz radio.

When I removed number 7 and then did a cold reset <see below>, the CPU cleared and showed me a L and a freq. I put .100 in. Press D/MR. Then a U appeared. I turned the VFO knob until 999.999 appeared. Press D/MR.

I also had to reenter the Repeater Split to the proper value.

On the VFO, I could QSY down to those limits (using F UP/DN) and listen to my local Channel 13 on 215.720/.660.

Yes, 216-220 Mhz is available with this mod. Great if 216-220 is the next 220 subband.

+++++  
 -NOTES-NOTES-NOTES-NOTES-NOTES-NOTES-NOTES-NOTES-NOTES-NOTES-NOTES-  
 +++++

<1> Cold Reset of the CPU Board.

With the radio upright and your nose pointing at the CPU board, look at the Lower Right Corner of the CPU chip. You will see two parallel SMT resistors. Below them is a screw with possibly a paper washer.

To the right is a SMT device (it's a cap) with a pointed end facing Left.  
Ground that point to the screw or to the case with a flat screwdriver.  
Awhile doing that, cycle on/off the radio to ensure a good reset.  
Remove screwdriver and then reassemble radio.

Dedicated to:

----- the knuckleheads in Barry Electronics who said it was impossible.  
----- Yaesu Tech Support who claimed that there are no RESET circuits  
in their radios, when their schematic diagrams say otherwise.

Special Thanks to:

Ken, N2MUK, for playing the guinea pig.  
Bobbie, KB2IFJ, for playing surgeon when I told him not to.

Please don't play with matches.  
W2Fwd.NY.USA.NA

=====

Note: I haven't tried or verified this, proceed at your own risk. And  
don't transmit out of band! WA2ISE





Newsgroups: rec.radio.info  
From: wa2ise@cbnewsb.cb.att.com (robert.f.casey)  
Subject: FT23 FT73 & FT211 mod files  
Message-ID: <1993Jan24.010618.6193@cbfsb.cb.att.com>  
Keywords: mods  
Sender: news@cbfsb.cb.att.com  
Organization: AT&T  
Date: Sun, 24 Jan 1993 01:06:18 GMT  
Approved: wa2ise@cbnewsb.cb.att.com  
Lines: 111

copied from packet:

| Msg#  | TSF | Size | #Rd | Date   | Time | From  | MsgID       | To          |
|-------|-----|------|-----|--------|------|-------|-------------|-------------|
| 33018 | BF  | 5506 | 0   | 13-Jan | 1158 | F1LOU | 30537_ON7RC | YAESU@WW () |

Sb: FT23/73/211 mods

MODS FOR FT23, 73 and 211:  
\*\*\*\*\*

9600 BPS with Yaesu FT-211RH  
-----

RX AUDIO:  
-----

On the RX "IF UNIT" (sub board F2869104) connect the screened lead inner to the TK10420 IC pin 9 with the outerscreen to pin 15. Caution should be taken to solder these if soldered to the underside of the board.

TX AUDIO:  
-----

On the rear of the "MAIN UNIT", a small potentiometer will be seen (peak deviation adjust.). Unsolder the leg nearest to the rear of the set, and connect the inner of the screened TX leads to this point, the outer to the earth plane adjacent to this point. To ensure that the 9600 bauds modem is terminated in the required impedance, it is essential that a suitable terminating resistor be placed across the screened lead inner/outer (a 560 ohm resistor); this may usefully be done at the FT-211RH potentiometer connection.

No further adjustments need to be made to the radio. On the tested modem a suitable level of 2.5 kHz deviation was achieved with one third rotation clockwise of the modem TX AF level potentiometer.

YAESU FT-23R case disassembly:  
-----

1) Remove the black screws from the top panel of the radio.

- 2) Remove the knobs.
- 3) Remove the black screws from the rear panel of the radio.
- 4) Remove the battery.
- 5) Remove the 6 screws on the bottom of the radio, where the battery attaches.
- 6) CAREFULLY remove the front panel of the radio.
- 7) In the left of the microprocessor and battery are several printed circuit jumpers. The jumpers labeled 7, 8 and 9 are for the frequency mods, like explained in the following.
- 8) Re-assemble the radio in the reverse order of these steps.
- 9) The Microprocessor will loose all what the memory contains.

YAESU FT211/23/73 band mods:  
-----

The uP's in the FT-23/73 and the FT-211 can be set for many frequency and memory mode combinations. These modes are controled by the jumpers (solder pads) marked 7,8 and 9 on the "CONTROL UNIT" board of either radio. Here is a list of what is possible:

| JUMPER |      |      | FREQUENCIES    |
|--------|------|------|----------------|
| 7      | 8    | 9    | COVERED        |
| open   | open | in   | 140 to 164 MHZ |
| open   | in   | in   | 140 to 160 MHZ |
| in     | open | in   | 144 to 148 MHZ |
| in     | in   | in   | 144 to 146 MHZ |
| open   | open | open | 220 to 550 MHZ |
| open   | in   | open | 440 to 450 MHZ |
| in     | open | in   | 50 to 300 MHZ  |
| in     | in   | open | 430 to 440 MHZ |

The FT-211 has separate VCO's for transmit and receive and will lock over about 38 MHZ from approx. 130 to 180 MHZ. The FT-23 has only one VCO and the overlap-ping lock range (Xmt & Rcv) is about 25 MHZ from approx. 135 to 175 MHZ. Don't forget, if you adjust the VCO you must realign every electronically tuned stage in the front-end of the radio. The transmitters can be tuned for somewhat higher power output above 164 MHZ but at a great power loss at 2m.

The non-amateur (commercial) memory mode will cause these functions changes:

1. When in the MR mode, the channel number will be displayed instead of frequency. You can toggle back to the original "amateur" mode display by pressing F<up-arrow>. Pressing F<down arrow> bring you back to commercial mode. However, when switching from D to MR, the display will always revert to the commercial mode.
2. The function of the Dot<Pri> button will be exactly reversed. That means now you can press just one button (Dot) to get into or out of the Primary function. The Pri funtion (in memory mode) will be indicated by a large "P" on the left

side of the display.

3.The only indication of low power operation is in the memory mode. A "C" will appear in the upper left corner of the display (where the primary "P" used to be). The bargraph will always read 100%.

4.The band scan is now even more useless. The uP will painfully count from 50 to 300 MHz.

FT23/73 in packet-radio:

-----

If you want to work in packet-radio, open jumper 10 to dissable the battery save.

73's de Phil, F1LOU @ ON7RC.BT.BEL.EU

=====

Note: I haven't tried or verified this, proceed at your own risk. And DO NOT transmit outside of legal bands! WA2ISE



Date: Wed, 18 May 88 10:25 EST  
From: <REID@IUBACS.BITNET>  
To: MBRAMWEL@BUSINESS.UWO.CDN

Subject: YAESU FT-23R EXTENDED FREQUENCY RANGE:

"Circumcising" the FT-23R is remarkably simple. Removing one solder blob (pad #7, clearly marked, 10 o'clock position from the speaker, 9 o'clock from the microprocessor) lets the radio receive and transmit from 140.0 to 163.995 MHz. The two circuit boards with surface-mount components are uncluttered. When opening the radio, be careful not to lose the tiny coil-spring inside the battery-release button. I haven't measured receiver sensitivity, nor do I know about performance in big-city RFI; the FT-23R is considerably more sensitive at 162-MHz weather frequencies than is my modified Icom IC-02AT.  
[source: W9MKV]



From: jpd@pc.usl.edu (Dugal James P.)  
Newsgroups: rec.radio.amateur.misc  
Subject: Yaesu FT2400H frequency mod  
Message-ID: <1992Feb18.212023.17600@usl.edu>  
Date: 18 Feb 92 21:20:23 GMT  
Article-I.D.: usl.1992Feb18.212023.17600  
Sender: anon@usl.edu (Anonymous NNTP Posting)  
Organization: Univ. of Southwestern La., Lafayette  
Lines: 21  
Originator: jpd@pc.usl.edu

>From Tom N5OFF:

FT-2400H Frequency Mod

-remove front panel (2 allen screws)  
-locate and unsolder jumper pad 2  
-locate and solder jumper pads 1 & 3  
-install front panel

result  
118-174 rx  
140-174 tx

-----  
cpu            battery                            6 5 4 3 2 1    <-jumpers  
-----

--  
-- James Dugal,                    N5KNX                                            Internet: jpd@usl.edu  
Associate Director                                            Ham packet: n5knx @k5arh (land), UO-14  
(sat.)  
Computing Center                                            US Mail: PO Box 42770    Lafayette, LA  
70504  
University of Southwestern LA.                            Tel. 318-231-6417                            U.S.A.





Newsgroups: rec.radio.info  
From: wa2ise@cbnewsb.cb.att.com (robert.f.casey)  
Subject: FT2400 mod file  
Message-ID: <1993Jan24.010836.6264@cbfsb.cb.att.com>  
Keywords: mods  
Sender: news@cbfsb.cb.att.com  
Organization: AT&T  
Date: Sun, 24 Jan 1993 01:08:36 GMT  
Approved: wa2ise@cbnewsb.cb.att.com  
Lines: 21

copied from packet:

| Msg#            | TSF | Size | #Rd | Date   | Time | From  | MsgID       | To          |
|-----------------|-----|------|-----|--------|------|-------|-------------|-------------|
| 32975           | BF  | 1830 | 0   | 13-Jan | 1146 | F1LOU | 30533_ON7RC | YAESU@WW () |
| Sb: FT2400 MODS |     |      |     |        |      |       |             |             |

YAESU FT-2400 expanded TRX frequency range:

-----  
Remove the 2 allen screws holding the front panel. On the "CONTROL UNIT", locate the Jumpers Points. JP2 must be OPEN, JP1 AND JP3 must be CLOSED with solder. When JP6 is CLOSED, you can use the 1750hz tone acces for european repeaters. The expanded range is 118 to 174 mhz on the display, but work only for 140 to 174 mhz.

73's de Phil, F1LOU @ ON7RC.BT.BEL.EU

=====  
Note: I haven't tried or verified this, proceed at your own risk. And DO NOT transmit outside of legal bands! WA2ISE



From elroy.jpl.nasa.gov!swrinde!gatech!paladin.american.edu!darwin.sura.net!  
haven.umd.edu!uunet!panther!mothost!schbbs!maccvm.corp.mot.com!CENG51 Sun Jan  
17 01:06:39 PST 1993  
Article: 32108 of rec.radio.amateur.misc  
Newsgroups: rec.radio.amateur.misc  
Path: elroy.jpl.nasa.gov!swrinde!gatech!paladin.american.edu!darwin.sura.net!  
haven.umd.edu!uunet!panther!mothost!schbbs!maccvm.corp.mot.com!CENG51  
From: CENG51@maccvm.corp.mot.com (Craig Witkowski)  
Subject: Yaesu FT-411E Mods  
Organization: Motorola  
Date: 15 Jan 1993 21:01:35 CST  
Message-ID: <1993Jan16.030433.3583@schbbs.mot.com>  
Sender: news@schbbs.mot.com (Net News)  
Nntp-Posting-Host: maccvm.corp.mot.com  
Lines: 166

A few days back, someone requested some mods for the FT-411E portable.  
In this post is some text I downloaded from a local ham BBS that told me how  
to do the mods to my portable. I have some receive dead zones in the 155 MHz  
region, but I can fairly well receive the weather broadcasts in the 162 MHz  
region.

This file is roughly 160-170 lines long.

ft411.idx

mods

out of band  
mod via computer  
packet  
extended freq range  
out of band

files

ft411 - ft411.4FT411

#Subject: FT-411 OUT OF BAND MODIFICATIONS

Date: 08 Feb 89

- 1) Open the front cover
- 2) Locate the C.P.U. unit (it is located on the front cover ).
- 3) Locate Jumpers 1,2,3 and 4 , These are the band setting Jumpers
- 4) Jumpers No 1,2 and 4 should be disconnected ,and Jumper No 3 should  
be connected.
- 5) Close the radio .
- 6) Apply power to the radio and turn it on.  
The display will initialize with memory No 1 flashing and the  
frequency display will show 1.000
- 7) Now , adjust the display to the desired lowest receive frequency  
When done ,press VFO.  
The memory CH will now show 2 flashing .
- 8) Adjust the display to the desired highest receive frequency

When done press VFO .  
The memory CH will now show 3 flashing .  
9) Adjust the display to the desired lowest transmit frequency  
When done ,press VFO.  
The memory CH will now show 4 flashing .  
10) Now , adjust the display to the desired highest transmit frequency  
When done ,press VFO.  
11) The rig is now set for your programed band on transmit and receive.  
CONTINUED IN FILE FT411.4

FT411.1

#Subject: FT411 MODIFICATION VIA COMPUTER

I was unhappy with the FT-411's "3" mode because the frequency had to be entered starting with the 100 MHz digit, and the ARS function would not work. I now use it in the "2" (normal) mode with the following mod.

I used the "clone" mode to dump the FT-411's ram to a computer. It's 9600 baud, 1 start bit, 1 stop bit, CMOS logic. 544 bytes are dumped when the up arrow is pressed. Starting with byte \$211 are the upper and lower transmit and receive frequencies, stored in BCD. I changed these to the limits I wanted. My FT-411's upper PLL limit is 195.4 MHz, so I used 195 MHz. The lower limit MUST remain set to 130 MHz (magic number) or the keyboard entry of frequencies will start with the 1 MHz digit .VS. the 10 MHz digit. To put the data back into ram, just press the down arrow and send the new 544 bytes to the FT-411. You could also just clone an H.T. that has the limits you want. You can not clone a mode "3" H.T. to a mode "2" H.T., however. The mode is contained in the first byte, which must match.

Bill Pherigo WR0Y

Note: I have not tried or verified this, proceed at your own risk!  
WA2ISEFT411.2

BID: 6495\_NO8M

From: N8LKT@NO8M

#Subject: FT 411 TO PACKET

FOR THOSE THAT WISH TO CONNECT A FT 411 TO PACKET VIA A MFJ TNC THE FOLLOWING MODIFICATIONS ARE NEEDED. IN THE BLACK LEAD FROM THE TX AUDIO OUT INSERT A .01-0.1UF CAP. IN THE RED LEAD FROM THE PTT, INSERT A 2.2K RST. THEN COMBINE THESE INTO A COMMON SINGLE LEAD CONNECTED TO THE TIP OF THE SMALL MIKE PLUG. THE YELLOW RX AUDIO GOES TO THE TIP OF THE LARGE SPEAKER PLUG. AND THE SHIELD GOES TO THE RING OF THE LARGE PLUG. THIS INFORMATION CAN BE FOUND IN THE 1989 AUGUST ISSUE OF 73. PAGE 58  
IT WORKES FOR ME .73'S N8KLT@NO8M.OH.U.S.A.NA  
RELAYED BY..N0KGX...GENE

FT411.3

Yaesu has sent out the following as an extended frequency coverage mod for the FT-411. I tried it and it works as advertised. First remove all black screws from case. Remove 4 silver screws holding the battery connector on bottom. Remove the 3 knobs. Carefully separate the front and back. There is a multiconductor trace between the front and back so hinge the front from the back to keep from putting too much tension on the traces. Looking at the board side of the front cover there are 8 little solder pads. They are half hidden

by a cover plate and the multiconductor trace. Pad 2 will have a solder connection, the rest are open. Remove the solder from the battery connector on bottom.

Remove the 3 knobs. Carefully separate the front and back. There is a multiconductor trace between the front and back so hinge the front from the back to keep from putting too much tension on the traces. Looking at the board side of the front cover there are 8 little solder pads. They are half hidden by a cover plate and the multiconductor trace. Pad 2 will have a solder connection, the rest are open. Remove the solder from pad 2 and place a solder bridge on pad 3. All other pads will be open. Close up radio.

Now when you turn on radio it will come up with 1.000 in the display. Memory channel should say 1. Program in the lower receive frequency.

Example 1 - 4 - 1 - 0 then push VFO key. The Memory channel should go to 2.

Now program in the upper receive frequency. i.e. 1 - 6 - 5 - 0 and push VFO key. Memory will move to 3. Do same for lower and upper transmit frequencies.

Note. The receiver sensitivity falls off at 162.55 to about 1 uv. The step and repeater offset will need to be re-programmed also. Follow instruction manual.FT

#### COMMENTS

-----

- 1) After the rig was programmed to the band and you want to change it to other ranges you will have to open the rig again and disconnect Jumper No 3 then to apply power to the radio ,turn it on again open it again ,connect Jumper No 3 back and repeat from steps 5 .

#Subject: FT-411 OUT OF BAND MODIFICATION

Date: 05 Feb 89

I discovered a nice trick to increase its frequency coverage.

It is so simple that you don't even have to open your hand held.

All you have to do is:

1. Make sure that the power switch is off.
2. press the UP arrow and DOWN arrow together, at the same time (those keys are also called A, and B. and they placed at the upper right side of the keypad)
3. Keep pressing both buttons and turn the power on.

Now you can receive 130-174Mhz, and transmit 140-150Mhz

CAUTION: When you do this modification the memories can be erased.

Ayhow I think it is not the end, and there are some more options.

If you do have some more information about this Hand held,

Please leave me a msg with it.

Tnx, AVIAD, 4X6TL@4Z4SV

CONTINUED IN FILE FT411.1

ft411.5

RECENTLY I SAW A MOD COME ACROSS THE SYSTEM ABOUT THE YAESU 411E PTT LOCK. THE SAME MOD IS AVAILABLE ON THE 411. JUST TURN OFF THE RADIO. HOLD THE PTT BUTTON AND THE #6 BUTTON WHILE TURNING ON THE RADIO. PRESS FM THEN 6. PRESS FM THEN 6 AGAIN THE LOCK AND THE PTT ICON WILL NOW BE ON. THATS ALL THERE

Craig Witkowski, KA2IBV, CENG51@maccvm.corp.mot.com

Motorola Communications & Electronics Inc.  
Glen Rock, NJ

Let's Go Racin'!

```
*****  
*  
*          **  **  ***          *****          *****  **          *****          *  
*          ***  **  ****          **  **  **          **  ****          **  **          *  
*          ** * **  ** **          **          **          ** **          *****          *  
*          **  ***  ******          **  **  **          **  ******          **  **          *  
*          **  **  **  **          ******          ******          **  **  **          **          *  
*  
*****
```

AMERICA'S ULTIMATE MOTORSPORT!





Subject: PTT MOD FOR FT-411

HELLO, A FEW DAYS AGO I WAS USING MY FRIEND'S YASEU FT-411 AND FOUND OUT THIS NEAT TRICK!!! FIRST, A LITTLE BACKGROUND... AS I'M SURE SOME OF YOU KNOW, YASEU CAME OUT WITH THE POPULAR 411 A FEW YEARS AGO. JUST RECENTLY, THEY CAME OUT WITH AN "ENHANCED" MODEL, THE 411-E. THE ONLY FOUND DIFFERENCE IS THE FREQUENCY LOCK OF THE RADIO. THE 411E HAS A FEATURE THAT LETS YOU LOCK THE PTT AS WELL AS THE FREQUENCY.

TO ACTIVATE PTT LOCK ON THE 411:

--TURN RADIO OFF  
--PUSH THE 6 BUTTON, HOLD IT AND TURN ON THE RIG WHILE YOUR STILL HOLDING IT.  
--NOW, PRESS FM 6, YOU SHOULD SEE "L".  
--PRESS FM 6 AGAIN, YOU SHOULD SEE "PTT" (BOTH L AND PTT WILL APPEAR IN THE BOTTEM LEFT CORNER OF THE LCD DISPLAY.

\*\*\*CONGRADULATIONS\*\*\* YOU HAVE INSTALLED PTT LOCK IN UR RIG. TO TURN IT OFF, JUST REPEAT THOSE STEPS.

MIKE-N2LPD @ N2IMC.NJ.USA.NA

-----  
Note: I haven't tried or verified this, proceed at your own risk. WA2ISE



Newsgroups: rec.radio.info  
From: wa2ise@cbnewsb.cb.att.com (robert.f.casey)  
Subject: FT415 & 815 mod files  
Message-ID: <1993Jan24.011350.6675@cbfsb.cb.att.com>  
Keywords: mods  
Sender: news@cbfsb.cb.att.com  
Organization: AT&T  
Date: Sun, 24 Jan 1993 01:13:50 GMT  
Approved: wa2ise@cbnewsb.cb.att.com  
Lines: 46

copied from packet:

| Msg#  | TSF | Size | #Rd | Date   | Time | From  | MsgID       | To          |
|-------|-----|------|-----|--------|------|-------|-------------|-------------|
| 33020 | BF  | 2383 | 0   | 13-Jan | 1213 | F1LOU | 30543_ON7RC | YAESU@WW () |

Sb: FT415/815 mods

YAESU FT-415 expanded frequency range:  
-----

Remove the screws holding battery track and rear cover.  
Locate the "CONTROL UNIT".  
Close jumpers 3, 5, AND 7 if not allready closed, 6 must be open. Let other jumpers unchanged.  
Reassemble the radio.  
Turn on the radio and program it as following:  
"1" 135.000 PRESS VFO THIS IS LOWER RX LIMIT  
"2" 185.000 PRESS VFO THIS IS UPPER RX LIMIT  
"3" 135.000 PRESS VFO THIS IS LOWER TX LIMIT  
"4" 185.000 PRESS VFO THIS IS UPPER TX LIMIT  
Press and hold MR, VFO and 2 while TURNING ON if you need to reset or reprogram the radio.

YAESU FT-815 expanded frequency range:  
-----

Same as above.  
Close jumpers 1, 5, and 7.  
Program 420 to 460 mhz as above.

NOTES:  
-----

Jumper 9 is for battery back-up.  
Jumper 10 is for 1750 Hz repeater tone acces.  
Jumper 1 is for 25 KHZ steps default value.

73's de Phil, F1LOU @ ON7RC.BT.BEL.EU

=====  
Note: I haven't tried or verified this, proceed at your own risk. And

DO NOT transmit outside of legal bands! WA2ISE



From: SV0DR@SV1IW  
To: ALL  
Subject: FT 4700 Mod

FT-4700 Frequency expanding modification.  
Following example shows programming for 138-174Mhz, and 420-460Mhz.

1. Remove front panel.
2. Locate jumper spots 1,2,5,9,10,13 and short them with solder carefully.  
(Other jumper spots must remain as current on the control unit.)

3. Turn power on, and set the display for the lower edge of UHF band (420.000), using up/down buttons, and dial. Then press D/MR button.

4. Set the display to 460.000 and press D/MR. The display shows 47.75 (if frequency of uhf). Press D/MR, and then uhf coverage is programmed.

5. Set the display freq. to 138.000 and press D/MR. Then set to 174.000 and press D/MR again. the display now shows the VHF frequency req. at 17.3. Press D/MR again. Now both band coverages are programmed.

6. After this modification the repeater shift is set to 000mhz, so it must be set using the F and RPT buttons on both bands. Refer to page 27 of manual for details.

7. Remember that transmitting outside the amateur bands is prohibited unless you have a special licence.

>>>  
>>>

73s to all and enjoy de Jimmy, SV0DR in Athens, GREECE.....



From elroy.jpl.nasa.gov!ames!olivea!gossip.pyramid.com!pyramid!infmt!seashore!  
randall Tue Jan 5 22:02:04 PST 1993  
Article: 31409 of rec.radio.amateur.misc  
Path: elroy.jpl.nasa.gov!ames!olivea!gossip.pyramid.com!pyramid!infmt!  
seashore!randall  
From: randall@informix.com (Randall Rhea)  
Newsgroups: rec.radio.amateur.misc  
Subject: Re: Yeasu FT-470 mods?  
Message-ID: <randall.726279986@seashore>  
Date: 6 Jan 93 00:26:26 GMT  
References: <9301041923.AA01850@mwunix.mitre.org>  
<1993Jan5.152228.17121@ke4zv.uucp>  
Sender: news@informix.com (Usenet News)  
Organization: Informix Software, Inc.  
Lines: 950

gary@ke4zv.uucp (Gary Coffman) writes:

>In article <9301041923.AA01850@mwunix.mitre.org> m22755@mwvm.mitre.ORG (Terry  
Alford) writes:  
>> A few weeks ago, I purchased an FT-470 2m/70cm HT. I've been monitoring  
>>this newsletter for about 2 months, but so far have found no references to  
any  
>>mods pertaining to this HT. I do not have access to ftp, but would welcome  
e-  
>>mail, or a posting here advising me of possible mods to increase receive  
>>bandwidth, etc. --- or any other information of interest about this model.

-----  
Yaesu FT-470 MODS  
Rev D (Aug 28, 1992)

This is a collection of hardware and software mods for the Yaesu 470.  
I have collected every mod seen on the net (ie. Usenet) since the  
introduction of the 470, so I think this list is fairly complete. I  
am interested in getting updates and corrections to this list, so  
please send me e-mail if you find something that needs updating.  
(This includes typos, wrong or missing attributions, caveats, warnings  
about unmentioned side effects, serial numbers of radios that won't do  
some of these mods, etc.)

SOME OF THESE MODIFICATIONS CAN DAMAGE YOUR RADIO IF YOU PERFORM  
THEM IMPROPERLY. WHEN IN DOUBT, DO NOT PERFORM THE MODIFICATION.

This advice is free, so remember that you get what you pay for.

Brian McMinn (brian@nucleus.amd.com)  
N5PSS  
512-462-5389

-----  
Full Reset:



Effect: Severe! :-)

- 1) Make hard (paper) copy of all memory info
- 2) Turn radio off
- 3) Hold down VFO and MR and turn radio on
- 4) Replace all memory contents

Notes: This will reset the auto repeater offset function, so you will need to re-enable it if you use it. This will also disable (mask) all memories except #1, so you will have to enable each of them by hand.

Attributed: Yaesu

---

MARS Mod:

Effect: Enable extended 2m receive, 2m transmit

- 1) Make hard (paper) copy of all memory info
- 2) Turn radio off
- 3) Hold down up-arrow and down-arrow and turn radio on
- 4) Replace all memory contents

Notes: This mod wipes all memory contents. This is a "toggle" mod in that it can be un-done by repeating the above steps. The normal->MARS mod only wipes the memories. The MARS->normal mod not only wipes the memories, it appears to do a complete controller reset (see above).

Result: Receive range 130-180 MHz, transmit 140-151MHz (I think, I haven't tried it.)

Attributed: Yaesu

---

Crossband Repeat:

Effect: Enable crossband repeat

- 1) Dial up two frequencies you want to crosslink (be sure to pay attention to transmit offsets, if any)
- 2) Turn radio off.
- 3) Hold down the RPT key and turn radio on

Result: The tone encode/decode flags and the +- flags will be flashing and the radio will be in low power mode. When either band's squelch opens, the other band is moved into the primary frequency display and the transmitter keys. Audio link appears to be speaker to mike.

Attributed: Collier Chun (NM7B @ WA7ARI)

---

Crossband Repeat Audio Cable:

Effect: Provide better audio for crossband repeat.

1) Parts:

- a) mini plug
- b) 100K ohm resistor
- c) sub-mini plug

2) Assemble cable with resistor connecting the tips of the two plugs. The shield (ground) is not connected.

3) Plug it between the earphone jack and the mike jack.

Result: Very good crossband audio. The level is controllable with the volume control.

Bugs: You can't listen to what is being repeated.

Attributed: Keith McQueen (N7HMF @ NV7V.UT.USA.NA)

=====  
Clone Mode:

Effect: Allow editing of transmit and receive frequencies.

- 1) Turn radio off.
- 2) Hold down F key and turn radio on.

Result: All segments of display are turned on. The radio will send data out the microphone tip when up-arrow is pressed. The radio will receive data when the down-arrow is pressed.

Bugs: I have yet to hear of someone who has done this successfully. Please tell me if you know how it works!

Attributed: szarekw@LONEX.RADC.AF.MIL (William J. Szarek)

=====  
Internal Jumper Mods:

Effect: Change radio from US to European to ???  
Wide band receive

I have located a total of eight straps, four to the left of the lithium battery, and four others under the flat white cable that interconnects the upper half with the lower half.

Yeasu FT-470 Straps

- R69 Vertical, at the 10 o'clock position by the lithium cell
- R68 Horizontal, to the lower left of R69
- R67 Horizontal, just below R68
- R66 Horizontal, just below R67

- R71 Vertical, the leftmost of three, to the left of the upper corner of the ribbon cable connector.
- R70 Vertical, the center of three of which R71 is the leftmost
- R72 Vertical, the rightmost of the three
- R74 Vertical, to the left of the ribbon cable connector, below the three. (Note that R74 is below an unpopulated capacitor that does not have a C number.

There is no R73, or at least it is not on the circuit board and it is not in the schematic. And, yes, the order of those three is indeed R71, R70, R72, left-to-right.

UHF CHOICES

| R71 | R70 | R72 | Rx and Tx    | Rx only    |
|-----|-----|-----|--------------|------------|
| 0   | 0   | 0   | 430 to 440   | 430 to 500 |
| 0   | 0   | 1   | 430 to 450   |            |
| 0   | 1   | 0   | 430 to 440   |            |
| 0   | 1   | 1   | 432 to 438   |            |
| 1   | 0   | 0   | 430 to 440** |            |
| 1   | 0   | 1   | 220 to 225   |            |
| 1   | 1   | 0   | 430 to 440   |            |
| 1   | 1   | 1   | 210 to 235   |            |

\*\* This is the normal European configuration.

VHF CHOICES

|            | R66 | R67 | R68 | R69 | Rx and Tx | Rx        |
|------------|-----|-----|-----|-----|-----------|-----------|
|            | 0   | 0   | 0   | 0   | 144 to    | 146130 to |
|            | 0   | 0   | 0   | 1   | 144 to    | 146       |
|            | 0   | 0   | 1   | 0   | 1260 to   | 1300      |
|            | 0   | 0   | 1   | 1   | 1240 to   | 1300      |
|            | 0   | 1   | 0   | 0   | 140 to    | 150*      |
| 130 to 180 | 0   | 1   | 0   | 1   | 140 to    | 174       |
|            | 0   | 1   | 1   | 0   | 303 to    | 343       |
|            | 0   | 1   | 1   | 1   | 8AL to    | 242       |
|            | 1   | 0   | 0   | 0   | 144 to    | 148       |
|            | 1   | 0   | 0   | 1   | 144 to    | 146**     |
|            | 1   | 0   | 1   | 0   | 1240 to   | 1300      |
|            | 1   | 0   | 1   | 1   | 404 to    | 444       |
|            | 1   | 1   | 0   | 0   | 140 to    | 160       |
|            | 1   | 1   | 0   | 1   | 1260 to   | 1300      |
|            | 1   | 1   | 1   | 0   | 101 to    | 141       |
|            | 1   | 1   | 1   | 1   | 1R3 to    | 158L      |

\* This is the normal US configuration after MARS mod.  
\*\* This is the normal European configuration.

(Note: the receive only ranges are enabled by powering up the unit with the up and down arrow buttons depressed...kjm)

When there is more than one combination which has the same frequency range, the difference is the default step size and/or the default repeater offset. Of course, choices that do not match the VCO and filters do not actually transmit or receive on those frequencies. A particularly strange example is that the VHF side of the set can be set to tune from 404 to 444 MHz, but again, it won't actually lock. Even in the 101-141 mode, the VHF VCO will not lock - this must be for use with some other sort of VCO (It looks like this would cover the aeronautical band rather nicely.) There are two really wierd VHF settings, those for 8AL-242 and 1R3-158L. These must be for use with some other LCD controller - it displays truly unusual and non sequential thins when stepped through the "bands".

R74 seems to have something to do with selecting the IF frequency, or something similar. When set, it really screws up the VHF reception.

My technique for determining these straps is to remove the straps that come in the unit, solder wires to each pad, run the wires out of the unit to a bank of DIP switches, screw the unit back together, and then go through all of the DIP switch combinations. I usually use a stereo microscope and 30 guage wire for this. Since I didn't try powering the unit on with every combination of keys held down for each DIP switch combination, there may still be other secrets possible.

I was looking for something like receive and transmit from zero to infinity, but I didn't find it. I determined, from studying the schematic, that there should be a hidden strapping diode from CPU pin 2 to CPU pin 22. I installed one, but nothing changed. In fact, changing it and powering the unit up did not cause a reset. Therefore, I concluded that this really wasn't a mystery strap, afterall. However, there could be others. I'm trying to get a data sheet for the CPU, from Hitachi, to see if any of the grounded pins are actually I/O pins -- they might be good candidates, particularly if their traces are routed in such a way as to be easily accessible for cutting.

I've learned that one of the ways to get some of the other, new Yeasu handhelds to go out-of-band involves dumping data out of the clone port, editing the data, and then dumping it back in. I called Yeasu and asked if the FT-470 could be cloned. They said no, so I ignored them. I haven't figured out how to get it to dump data, but I believe it will accept data. The clone mode is entered by powering up the unit with the F key held down. (It's also a neat way to see all of the indicators on the LCD!) The data must be presented in the

ring ("right channel") of a stereo 2.5 millimeter plug which is placed into the mic jack. This is cryptically marked on the schematic, anyway. However, I have no idea what the format for the data should be. If you come across this, I'd love to know. This may be the trap door to getting the rig to receive and transmit in more interesting places.

Attributed: Ed Boakes (WB3FLD) att!hocpa!ewb

-----  
VHF Transmit mod:

Effect: Enables extended VHF transmit (this is exactly the same as one of the previously listed mods).

- 1) Open the radio such that the two halves open like a sandwich.
- 2) Locate the internal lithium battery
- 3) Locate several solder pads to the left of the lithium battery.
- 4) Just to the top left of the lithium battery is ONE vertical solder pad (a.k.a. R69). It is almost under the top left edge of the battery.
- 5) solder a jumper across this pad.

Result: Extended VHF transmit

Bugs: The automatic repeater shift (- offset below 147, + above etc...) goes away with this mod.

Attributed: randall@informix.com (Randall Rhea)  
Also attributed to: Bernie NU1S @ K1UGM

-----  
Software UHF Receive Expansion:

Effect: extend UHF Rx to 500MHz without shrinking Tx range

How: Trick 470 into accepting big number in U register.

Caveat: This mod acts differently on different radios.

- 1) Turn the beep on. (Some, perhaps all, 470's require that the key-press-beep function be on in order to do this.)
- 2) Program the frequency of 450.00 MHz simplex.
- 3) Set the repeater offset to zero (F/M RPT 0000) but DON'T get out of the set mode (don't hit RPT again).
- 4) Turn the radio off then back on.
- 5) Set a "+" offset (press RPT twice).
- 6) Press the REV button one time.
- 7) The radio should now display 1450 MHz. (The radio will not operate at these frequencies. My service monitor shows that above 500 MHz the rx is very weak.)
- 8) Use the shifted down-arrow key to tune this frequency down to around 500 MHz (press F/M, press and hold down-arrow). Yes, this takes a while.
- 9) Store this in the "U" memory. (press and hold F/M until

you hear two beeps, rotate tuning knob until "U" appears in upper left, press F/M again).

10) Reset the repeater offset to 5 MHz. (F/M RPT 0500 RPT)

Result: By selecting the "U" memory and the using the memory tune fuction (select "U" memory and then press MR), you can tune to the desired frequency and then store it in another memory.

Bugs: Above 500 MHz, some radios will let you tune up and down in frequency, some won't (they jump back to the ham band). Some radios will let you enter a frequency above 500 MHz on the keyboard while in memory tune mode, some won't.

Attributed: Darrell Sego KM9S

=====

#### Software Range Extention Tricks:

Effect: Force a non-standard frequency into a VFO, store this as an upper limit in the "U" or "L" memory.

Caveat: For these steps to work properly, I had to have "Beep" enabled and \*NOT\* have the "L" and "U" memories locked out.

Steps for setting the UPPER UHF limit to 500 MHz

1. Program the frequency for 430.00 MHz \*SIMPLEX\*.
2. Press F/M, then RPT for the offset.
3. Enter the code 0000 into the keypad.
4. Shut the transceiver off, then turn it back on.
5. Press RPT key twice for a "+" (plus) offset indication.
6. Press REV button once.
7. The radio should now display 1430.00 MHz.
8. Press F/M then hold the down-arrow key to lower the displayed frequency. Stop when 500.00 MHz is displayed.
9. Press RPT once to select simplex operation.
10. Press F/M and hold until you hear two beeps.
11. Rotate the (DIAL) knob until the channel "U" is displayed.
12. Press F/M again, you should hear a beep.
13. Press F/M then RPT then enter 0500 (5 MHz repeater offset) then press RPT again.

- alternative procedure (faster but a little more complicated)

8. Press RPT twice to select the "-" repeater offset.
9. Press REV twice. Frequency shown should be 630.00 MHz.
10. Press F/M then hold the down-arrow key to lower the displayed frequency. Stop at 500.00 MHz.
11. Press RPT twice to select simplex operation.
12. Go back to #10 in previous list...

=====

Steps for setting the LOWER UHF limit to 400 MHz.

1. Program the frequency for 450.00 MHz \*SIMPLEX\*.
2. Press the F/M, then RPT for the offset.
3. Enter the code 0000 into the keypad.
4. Shut the transceiver off, then turn it back on.
5. Press RPT once (for a "-" (minus) indicated offset).
6. Press REV \*THREE\* times.
7. The radio should now display 050.00 MHz.
8. Press F/M, then hold the up-arrow key to increase the displayed frequency. Stop at 400 MHz.
9. Store this in the "L" memory. (See above steps...)
10. Press F/M then RPT then enter 0500 (5 MHz repeater offset) then press RPT again.

- alternative procedure

- note: this short-cut requires you to enter 430.00 MHz in step 1.

5. Press RPT twice for a "+" (plus) indicated repeater offset.
6. Press REV once.
7. Press RPT twice to select the "-" (minus) repeater offset.
8. Press REV once. You should have 1030.00 MHz displayed.
9. Press F/M and hold the down-arrow stopping at 999.00 MHz.
10. Press REV once. You should have 399.00 MHz displayed.
11. Press F/M, then hold the up-arrow) key to increase the displayed frequency. Stop at 400 MHz.
12. Press RPT twice to select simplex operation.
13. go back to #9 in previous list

-----  
Steps for setting the UPPER VHF limit to 200 MHz.

1. Program the frequency for 140.00 MHz \*SIMPLEX\*.
2. Press F/M, then RPT for the offset.
3. Enter the code 0000 into the keypad.
4. Shut the transceiver off, then turn it back on.
5. Press RPT twice (for a "+" (plus) indicated offset).
6. Press REV \*ONE\* time.
7. The radio should now display 1140.00 MHz.
8. Press F/M, then hold the down-arrow key to decrease the displayed frequency. Stop at 800 MHz.
9. Press RPT twice to select the "-" (minus) repeater offset.
10. Press REV once. You should have 200.000 MHz displayed.
11. Press RPT twice to select simplex.
12. Store this in the "U" memory. (See above steps...)
13. Press F/M then RPT then enter 0060 (600 Khz repeater offset) then press RPT again.

-----  
Steps for setting the LOWER VHF limit to 100 MHz.

1. Program the frequency for 140.00 MHz \*SIMPLEX\*.
2. Press the F/M, then RPT for the offset.
3. Enter the code 0000 into the keypad.

4. Shut the transceiver off, then turn it back on.
5. Press RPT twice (for a "+" (plus) indicated offset).
6. Press REV \*ONE\* time.
7. The radio should now display 1140.00 MHz.
8. Press F/M, then hold the down-arrow key to decrease the displayed frequency. Stop at 1100 MHz.
9. Press RPT twice to select the "-" (minus) repeater offset.
10. Press REV twice. You should have 100.000 MHz displayed.
11. Press RPT twice to select simplex.
12. Store this in the "L" memory. (See above steps...)
13. Press F/M then RPT then enter 0060 (600 Khz repeater offset) then press RPT again.

-----  
Notes: To use the higher frequencies you have to select the "U" channel and press MR. This puts the handheld in the "MT" (memory tune) mode. From there you can scan down or use the (DIAL) knob

to

go to a lower frequency. ...Likewise for the lower frequency memory. Any frequency selected using this method can be stored in any memory.

the

My radio will not let me go up in frequency, only down. If I try, rig will default back to the original ham band. I had to be careful when doing these mods.

MHz

One trick I found when initially setting up the VFO with the expanded upper and lower frequencies is that in steps 5 (and 9) if you select "+", pressing REV adds 1000 MHz to the display or subtracts 1000 MHz if it has already been added. If you selected the "-" (minus) repeater offset, pressing REV will subtract 400

many

if the displayed frequency is 1000 MHz or higher, or subtract 600 MHz if the displayed frequency is below 1000 MHz, until any more subtractions would run the frequency negative, after which it alternatively adds or subtracts 600. You can mix the up-arrow down-arrow method with the "+ -" offset/REV combination to reduce the time getting to the desired frequency. With these tricks,

quickly.

permutations can be found to get where you want to be very

I have discovered the code "5555" works as well as "0000" for the enabling code.

Attributed: fletcher@lode.uwyo.EDU (Walter Reid Fletcher, WB7CJO)

-----  
Fix One-Way Tune Bug in Expanded Receive:

Effect: Allow tuning in both directions when software range extend mods have been performed.



Due to a loophole in the tuning software, you may tune from the current frequency towards the normal operating range (430.00 - 450.00), but not away.

Unfortunately, you are still subject to the "tune one way only" syndrome. To bypass it, you must store some frequency in the "L" memory. It doesn't matter what this frequency is, but it has to

be

below the "U" memory and, preferably, below any other frequency

you

want to use. You may store a very low frequency here too (0.00MHz).

BUT, the software isn't that dumb. To trick it, both the "L" and "U" memories must be filled and active (not set for SKIP), AND you must access the out of band frequencies from the MT (memory tune) mode, AND you must start from either the "L" or the "U" memory.

To use MT:

- 1) Press MR and select either the L or U memory.
- 2) Press MR again, a small MT should appear on the left of the display.
- 3) You may now tune with the arrow keys, Dial knob, or directly enter frequencies with the numeric keypad.

Attributed: kd6hr.El\_Segundo@xerox.com (Pete McAfee)  
[ed. It looks like Pete may have been the first to discover some of these neat tricks... any comments?]

-----  
Out of Band Sensitivity:

Effect: This is not a mod. Just information.

I measured the sensitivity of my Yaesu FT-470 over frequency to see how well it holds up outside of the ham bands. I wanted to see how useful the extended receive info being handed out really was.

The measurement is a relative one. I was using an HP8657 Signal Generator, with the internal FM modulation set to 5 KHz deviation and a 400 Hz tone. I input a signal with an amplitude of -100 dBm directly into the RF input of the radio. I noted the reading on the signal strength meter in the Yaesu. On the VHF band the number nine was on steadily, on the UHF band the number nine was blinking. As I changed frequencies I adjusted the amplitude of the signal generator to keep the signal strength meter on the Yaesu at the same level. The amount I had to crank up the output of the signal generator is the reduced sensitivity, here is the data:

| VHF   |                       |
|-------|-----------------------|
| freq: | relative sensitivity: |
| 136   | -14 dB                |
| 140   | -3 dB                 |

|     |        |                 |
|-----|--------|-----------------|
| 144 | +1 dB  |                 |
| 146 | 0 dB   | reference point |
| 148 | -1 dB  |                 |
| 155 | -6 dB  |                 |
| 160 | -22 dB |                 |
| 165 | -29 dB |                 |
| 170 | -38 dB |                 |
| 174 | -44 dB |                 |

UHF:

|       |                                   |
|-------|-----------------------------------|
| freq: | relative sensitivity:             |
| 400   | no reading, nothing, -infinity dB |
| 401   | -40 dB                            |
| 402   | -38 dB                            |
| 405   | -34 dB                            |
| 410   | -27 dB                            |
| 420   | -9 dB                             |
| 430   | +1 dB                             |
| 440   | 0 dB                              |
| 450   | 0 dB                              |
| 460   | -17 dB                            |
| 470   | -26 dB                            |

Results: The radio is good outside the ham bands, but the sensitivity really starts to suffer. I hear the local police at 460.375 quite well, so -17 dB is still usable, but not as good as a scanner would probably be. VHF down to 100 MHz or UHF down to 400 MHz is a fantasy. As I mentioned in another post, if the frequency ranges are extended too far, you start picking up signals at the wrong frequencies. National weather service (162.4) received at 119 MHz, coast guard channel 12 (156.8) received at 200 MHz, 2 meter repeaters received around 190 MHz and again around 182 MHz. Its hard to say just what the usable ranges are, but something like 136-165 MHz in VHF and 410-470 MHz in UHF, and even then its not great at the ends of these ranges.

Attributed: frankb@hpsad.HP.COM (Frank Ball)

-----

Hyperscan:

Effect: faster memory scan rate.

- 1) Go into Alt mode by pressing [F] 2 (Alt).
- 2) Press the Up or Down Arrow to activate the Memory Scan.
- 3) When the Scans stops on a VHF frequency on the Left Display

(The

Main Band), Hit [F] VFO.

- 4) Press the Up or Down Arrow to activate the HyperScan.
- 5) To Stop the Function, Press [F] Alt.

Result: Faster scan rate. (Mod is non-permanent)

Attributed: KB2JFI ???

-----  
Extended RCV side effect #1:

I have found what I would consider an interesting side effect with my FT-470 now that I have performed the UHF extended receive modification. [not sure which UHF mod this is, ed.]

After I had done this mod, I found out that if I was scanning (in either Memory Tune mode or band-scan mode (between U & L)) the VHF side of the radio in the sub-band, and listening to an extended frequency in the UHF main band, the scanning would stop and revert back to whatever frequency it started from whenever a signal was received on the UHF side. (I don't know what frequency it reverts back to if you are scanning a VFO, but I do know that a similar thing happens).

Attributed: v108qhu6@ubvmsd.cc.buffalo.edu (David N Smernoff)

-----  
1750Hz tone burst:

FT470's in the UK come with the 1750 Hz tone burst option built in. It is on a tiny sub card that is wedged in down the bottom at one side. I bought one from the UK distributors and figured out how to connect it when I got back to the US. As far as I can tell my mod is the same as would be done if it was officially installed although the service manual doesn't show where to connect it. It has just 3 wires, power, ground and audio out. It is activated by applying power using the small button above the PTT so you can press both at once to call and then slide your thumb down to release the tone button.

The board consists of a 2\*color burst freq xtal and a 74HC4060 CMOS oscillator divider giving 7.16MHz divided by 4096 = 1748 Hz. The chip is surface mounted so they can get the whole thing down to less than 0.5" square.

Attributed: gingell%aurfs1%aurgate@mcnc.org (Mike Gingell)

-----  
Battery latch R&R:

To replace the battery latch simply remove the battery pack. Looking at the bottom of the transceiver you will see the battery retainer plate. Remove the 4 screws from each connor and lift the plate out. The battery latch will come with it. Part of the retainer plate is used as a spring for the latch. Stick the new catch on the end of the spring and reinstall in reverse order.

I have broken mine twice so far. The rest of the radio seems to be pretty rugged and I have given mine a lot of

punishment so far and it seems to have taken it well.

Attributed: rogerm@hpfco.FC.HP.COM (Roger Mitchell)

=====

Extended RCV side effect #1:

After doing the software receive mod, the radio will pick up 2m frequencies when the display is in the 180-190MHz range.

Also, the ARS (Automatic Repeater Shift) will turn on once in a while when scanning from 100 MHz to 200 MHz.

Attributed: plkorhon@vipunen.hut.fi (Mikko Noromaa)

=====

TNC wiring:

The FT470 is wired like an Icom. You connect the audio from the TNC to the tip of the mike plug through a capacitor and connect the PTT to the tip with a resistor. The Icoms and Yaesus use a "leaky ground" to generate PTT. The problem with this approach is there is a tradeoff between rapid PTT and audio level and response. Typical values are .1 ufd and 2.2 k ohms. The RC time constant limits TR turnaround.

A better scheme is to use a tiny audio transformer sideways like so,

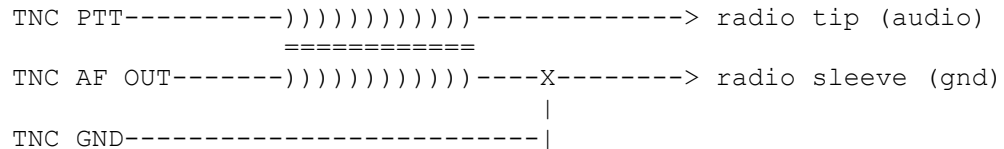

You can rip a suitable transformer out of an old transistor radio or buy one from Radio Shack.

You should carefully set the audio level so you wind up with a 3 khz deviation for your tones. Don't exceed that level or many units will have trouble decoding your packets. Make sure you have the power saver on the 470 turned off when you run packet or you'll miss the first part of every packet. This can drive you nuts because everything seems to be working but nothing prints.

One last note: put some distance between the antenna and the radio and use shielded cables on your TNC. Otherwise the RFI and RF feedback will ruin your packet operation.

Attributed: gary@ke4zv.uucp (Gary Coffman, KE4ZV)

=====

DC power:

The 2 meter only model does have a power jack under the rubber plug, but the 470 doesn't. There's a place on the board for one, but Yaesu recommends that you use a PA-6 module instead. This is a module that mounts in place of the battery and contains regulators for running the radio and charging a battery connected to the bottom of the PA-6. This is a really nice accessory and well worth the price.

Attributed: gary@ke4zv.uucp (Gary Coffman, KE4ZV)

-----  
Power Consumption:

Here are some measurements on the Yaesu FT470. Measurements made with regulated 7.2 volt supply. Power output measured with Bird and appropriate slugs.

2 Meter Transmit

LOW POWER- RF OUTPUT: 1 WATT DRAIN: 400 ma  
HI POWER- RF OUTPUT: 3 WATTS DRAIN: 700 ma

70cm Transmit

LOW POWER- RF OUTPUT: 1 WATT DRAIN: 550 ma  
HI POWER- RF OUTPUT: 2.4 WATTS DRAIN: 800 ma

Receive

As used below, "standby" means squelch closed, no signal received.

Note: "PRIORITY" disables "APO", but not "SAVE"

Note: Scanning disables both "SAVE" and "APO"

Note: Open squelch disables "SAVE"

SCAN or STANDBY, one band: 53 ma  
SCAN or STANDBY, two bands: 90 ma  
STANDBY, "SAVE", one band: 10 ma (53 ma active)  
STANDBY, "SAVE", two bands: 10 ma (90 ma active)  
"APO" does not change above.

Audio: 50 - 150 ma

WARNING: The FT470 shuts down and display goes blank when supply voltage drops to about 4.8 volts. BUT DRAIN CONTINUES AT ABOUT 10 ma. So, there is a danger of over-discharging nicads. Shut your equipment off to prevent this.

Attributed: WA2NQL  
-----

Intermod Cure:

I sent my Yaesu 470 in to Yaesu U.S.A. almost a month ago for them to perform the modification to cure the intermod problem and got it back yesterday. They did cure the problem. There is no intermod at all on one repeater that I was previously getting killed on. There is also a noticeable improvement in the sensitivity out of band on the weather frequencies. Though my radio is almost 2 years old they did the work free of charge. I tried to have them send me the parts to do it myself but I couldn't talk them into it.

Attributed: rogerm@hpfco.FC.HP.COM (Roger Mitchell)

-----  
Intermod Cure -- Affected Lot numbers:

There is a free factory upgrade for the FT-470 that applies to models from certain lot numbers. I believe lot #19 and lower have terrible intermod problems. Mods are made (supposedly) to IF stages etc... and sensitivity as well as selectivity are increased after the mod. There may be other lots that have problems as well (I know lot #30 has quite a number of problems ie. batt saver not functioning correctly, low output power, mushy squelch etc...). The lot number is usually the first two digits of the serial.

Attributed: Craig Lemon VE3XCL

-----  
More About Intermod:

The u2AT uses a varactor tuned front end filter to reduce intermod. It is able to knock out a lot of out of band signals while still maintaining a wideband receive capability. The tune voltage for the varactors is developed from the VCO tune line.

There is a difference between intermod and spurious. Intermods are developed when two out of channel signals mix to produce an in channel response. Third order intermod occurs when the second harmonic of one of these signals mixes with the other to produce an in channel response. For example say there are two repeaters on 146.88 and 146.82. These two frequencies will develop 3rd order products at 146.76 and 146.94. Tuning the receiver to either of these frequencies you would hear both conversations at the same time (assuming their signal levels were high enough to cause the intermod).

A spurious response results when a single input signal, at a frequency other than the desired receive frequency, mixes with the first LO to produce an output at the first IF. For instance suppose that I am tuned to 145.21 MHz and my first IF is at 21.7 MHz (as is the case in the 470). My first LO is 21.7 MHz above 145.21 MHz or at 166.91 MHz. A signal at 156.06 MHz will generate a spurious response at 21.7 MHz since

$2*166.91-2*156.06=21.7$  . Thus the second harmonic of the LO mixing with the second harmonic of the spur frequency ends up in the IF. Just how susceptible the receiver is to this spur product depends upon the design of the first mixer and the gain and linearity of the preamplifier, as well as the ability of the input filter to reject 156.06 MHz. Since the VHF front end is fairly broad, the filter will do little good.

I suspect the IF frequency change in the 470 occurred as a result of spurious problems, since the IF frequency should not affect the intermod dynamic range. In fact, another ham in the area brought his 470 over and we checked it for its intermod performance and it was identical to mine, however his had the original 17.3 MHz VHF IF. Thus I guess my performance is typical. From email I have received since my original posting, it appears that this type of performance is typical for dual band radios made by all of the major manufacturers.

Attributed: Jim Summers, KD7F

-----  
Finding the IF:

The Yaesu intermod fix changes both the first IF and second LO frequencies. The following changes are made:

|                  |           | original  | modified  |
|------------------|-----------|-----------|-----------|
| RF Unit - XF2001 | 17N15AU   |           | 21R15AU   |
| - XF2002         | 45N15A1   |           | 47M15AU   |
| - L2007          |           | 4.7uH     | 3.3uH     |
| - L2008          |           | 4.7uH     | 3.3uH     |
| IF Unit - X3001  |           | 16.845MHz | 21.245MHz |
| - X3002          |           | 44.615MHz | 47.265MHz |
| IF Frequency     |           | 17.3MHz   | 21.7MHz   |
| Second LO        | 16.845MHz | 21.245MHz |           |

You can hear the second LO frequency with a general coverage receiver in SSB mode. As suggested by Al Rabassa, wrap the FT-470 with several turns of insulated wire and connect the wire to the antenna connector of the GC receiver. The 2nd LO frequency should be received.

You can also hear the first LO with a scanner. The first LO will be at a frequency equal to the FT-470's displayed frequency plus the IF frequency.

Another way to tell is to hook up a spectrum analyzer to the antenna input (Be careful not to transmit!!!) and look at the first LO leakage. It is very easy to see on my radio (about -50 dBm). The first LO will be offset from the receive frequency by the first IF frequency. At 144 MHz the LO will be at 165.7 MHz. For receive frequencies above 157 MHz, low side injection is used.

Attributed: Jim Summers, KD7F

-----  
Opening Battery Cases:

I've opened several FNB-x cases in order to replace the cell pack. The procedure that I've used is very simple, but does require patience to prevent damage to the case:

1. Cut the white label with a sharp knife by following the case separation line. DO NOT remove the nut on the charging connector.
2. Pry the case halves apart by placing a thin wide bladed screwdriver into the case line on the label end. It may be necessary to separate the black band from one case half with a knife tip when it is evident that glue has penetrated the joint. NOTE: The black band is permanently attached to one case half.
3. Use continuous pressure, not excessive force, to separate the case halves. Concentrate the separation procedure on the label end of the case. The steady pressure will allow the glue to cold flow and release its grip.
4. Yes, a frustration level will occur, but then success will appear as the glue gives up after a few minutes.
5. Make a note of where the wires attach to the battery and thermal switch. Also note the pack orientation.
6. Connect the replacement pack into the case and attach the wires per your note in step 5.
7. Close the pack, charge the cells, attach to the radio for a test.
8. If satisfied, place a spot (1/2 inch dia) of clear RTV on each side of the cell pack and press the case together and place it under a weight for a short time until the RTV cures. Because of the reduced amount of glue, the case will have a more flimsy feel than previous to replacement, but will perform like the original.
9. For the next replacement, the RTV will give up much easier than the original glue.

Attributed: Hugh Wells, W6WTU

-----

UHF Transmit Extend:

Since I always get about a dozen requests for ANY information on extended UHF transmit, I'll try to head them off by saying that I have NEVER heard of one. Rest assured that I will add any such mod to this list and IMMEDIATELY repost it!



Brian

=====

end of Rev D mod list...

=====

--

=====

Randall Rhea  
Project Manager, MIS Sales/Marketing Systems

Informix Software, Inc.  
uunet!pyramid!infmt!randall



Date: 25 Aug 90 02:54:33 GMT  
From: swrinde!mips!prls!philabs!briar!rfc@ucsd.edu (Robert Casey)  
Subject: FT470 extended VHF xmit mod file  
To: info-hams@ucsd.edu

FT-470 mod extended VHF xmit....

Here's the mod for the FT-470. (I have not performed it myself)

1. Remove Cover
2. Remove Lithium battery carefully
3. On left hand side locate some empty vertical pads, one above the other. It should be marked as R-69. There is also a chip resistor R-67 that is just below it to the left a bid.
4. Place a solder jumper across the two R-69 pads.
5. Reinstall the lithium battery.
6. Closeup the Radio.
7. Turn the radio of. While pressing down the up and down arrow keys, turn the radio back on.

Note: This mod only opens up the VHF transmit frequency range beyond 140 to 150. The automatic repeater offset will be defeated so you will have to enter the +/- offset yourself.

73's Bernie NU1S @ K1UGM

Note: I haven't tested this, proceed at your own risk. Don't transmit out of band, else you might get a fine or even do time.  
WA2ISE

-----  
Date: 26 Aug 90 00:39:28 GMT  
From: mailrus!hellgate.utah.edu!uplherc!wicat!keithm@tut.cis.ohio-state.edu  
(Keith McQueen)  
#Subject: FT-470 mods  
To: info-hams@ucsd.edu

I have received enough enquiries about mods for the Yaesu FT-470 hand held, that I have decided to post what I know.

(This is a transcription of a letter that I received detailing the CPU programming jumpers that were found experimentally by Ed Boakes, WB3FLD. Keith, N7HMF)

Dear Keith,

A little while ago, I came across a Net News item from you about the Yeasu FT-470 handheld. You asked if anyone knew how to make it receive the public service band just above the UHF amateur band. Well, I've figured out how to do that. However, the bad news is that when you strap the unit for this mode, it only transmits from 430 to 440! Oh, well.

I gave you a phone call a week or so ago, but it seemed that we kept missing each other. Anyway, here is what I've learned about the

FT-470: I have located a total of eight straps, the four which you had written about, to the left of the lithium battery, and four others located under the flat white cable that interconnects the upper half with the lower half.

YEASU FT-470 STRAPS

R69 Vertical, at the 10 o'clock position by the lithium cell  
 R68 Horizontal, to the lower left of R69  
 R67 Horizontal, just below R68  
 R66 Horizontal, just below R67

R71 Vertical, the leftmost of three, to the left of the upper corner of the ribbon cable connector.  
 R70 Vertical, the center of three of which R71 is the leftmost  
 R72 Vertical, the rightmost of the three  
 R74 Vertical, to the left of the ribbon cable connector, below the three. (Note that R74 is below an unpopulated capacitor that does not have a C number.

There is no R73, or at least it is not on the circuit board and it is not in the schematic. And, yes, the order of those three is indeed R71, R70, R72, left-to-right.

R70, R71, R72 select the mode for the UHF portion of the FT-470. The choices are:

|     |     |     | UHF CHOICES    |                |
|-----|-----|-----|----------------|----------------|
| R71 | R70 | R72 | Rx and TX      | Receive only   |
| 0   | 0   | 0   | 430 to 440 Mhz | 430 to 500 Mhz |
| 0   | 0   | 1   | 430 to 450 Mhz |                |
| 0   | 1   | 0   | 430 to 440 Mhz |                |
| 0   | 1   | 1   | 432 to 438 Mhz |                |
| 1   | 0   | 0   | 430 to 440 Mhz |                |
| 1   | 0   | 1   | 220 to 225 Mhz |                |
| 1   | 1   | 0   | 430 to 440 Mhz |                |
| 1   | 1   | 1   | 210 to 235 Mhz |                |

R66, R67, R68 and R69 select the mode for the VHF portion of the FT-470. The choices are:

|     |     |     |     | VHF CHOICES      |                |
|-----|-----|-----|-----|------------------|----------------|
| R66 | R67 | R68 | R69 | Rx and Tx        | Receive only   |
| 0   | 0   | 0   | 0   | 144 to 146 Mhz   | 130 to 180 Mhz |
| 0   | 0   | 0   | 1   | 144 to 146 Mhz   |                |
| 0   | 0   | 1   | 0   | 1260 to 1300 Mhz |                |
| 0   | 0   | 1   | 1   | 1240 to 1300 Mhz |                |
| 0   | 1   | 0   | 0   | 140 to 150 Mhz   | 130 to 180 Mhz |
| 0   | 1   | 0   | 1   | 140 to 174 Mhz   |                |
| 0   | 1   | 1   | 0   | 303 to 343 Mhz   |                |
| 0   | 1   | 1   | 1   | 8AL to 242 Mhz   |                |
| 1   | 0   | 0   | 0   | 144 to 148 Mhz   |                |
| 1   | 0   | 0   | 1   | 144 to 146 Mhz   |                |
| 1   | 0   | 1   | 0   | 1240 to 1300 Mhz |                |
| 1   | 0   | 1   | 1   | 404 to 444 Mhz   |                |
| 1   | 1   | 0   | 0   | 140 to 160 Mhz   |                |
| 1   | 1   | 0   | 1   | 1260 to 1300 Mhz |                |
| 1   | 1   | 1   | 0   | 101 to 141 Mhz   |                |

1 1 1 1 1R3 to 158L Mhz  
(Note: the receive only ranges are enabled by powering up the  
unit with the up and down arrow buttons depressed...kjm)

When there is more than one combination which has the same frequency range, the difference is the default step size and/or the default repeater offset. Of course, choices that do not match the VCO and filters do not actually transmit or receive on those frequencies. A particularly strange example is that the VHF side of the set can be set to tune from 404 to 444 Mhz, but again, it won't actually lock. Even in the 101-141 mode, the VHF VCO will not lock - this must be for use with some other sort of VCO (It looks like this would cover the aeronautical band rather nicely.) There are two really wierd VHF settings, those for 8AL-242 and 1R3-158L. These must be for use with some other LCD controller - it displays truly unusual and non sequential things when stepped through the "bands".

R74 seems to have something to do with something like selecting the IF frequency, or something else like that that. When set, it really screws up the VHF reception.

My technique for determining these straps is to remove the straps that come in the unit, solder wires to each pad, run the wires out of the unit to a bank of DIP switches, screw the unit back together, and then go through all of the DIP switch combinations. I usually use a stereo microscope and 30 guage wire for this. Since I didn't try powering the unit on with every combination of keys held down for each DIP switch combination, there may still be other secrets possible.

Since I was looking for something like receive and transmit from zero to infinity, and I didn't find it, I kept looking until I got bored and wanted to button the thing up and start using it. I determined, from studying the schematic, that there should be a hidden strapping diode from CPU pin 2 to CPU pin 22. I installed one, but nothing changed. In fact, changing it and powering the unit up did not cause a reset. Therefore, I concluded that this really wasn't a mystery strap, afterall. However, there could be others. I'm trying to get a data sheet for the CPU, from Hitachi, to see if any of the grounded pins are actually I/O pins -- they might be good candidates, particularly if their traces are routed in such a way as to be easily accessible for cutting.

I've learned that one of the ways to get some of the other, new Yeasu handhelds to go out-of-band, involves dumping data out of the clone port, editing the data, and then dumping it back in. I called Yeasu and asked if the FT-470 could be cloned. They said no, so I ignored them. I haven't figured out how to get it to dump data, but I believe it will accept data. The clone mode is entered by powering up the unit with the F key held down. (It's also a neat way to see all of the indicators on the LCD!) The data must be presented in the ring ("right channel") of a stereo 2.5 millimeter plug which is placed into the mic jack. This is cryptically marked on the schematic, anyway. However, I have no idea what the format for the data should be. If you come across this, I'd love to know. This may be the trap door to getting the rig to receive and transmit

in more interesting places.

Have fun with you FT-470!

Yours Truly,  
Ed Boakes

CALL: WB3FLD  
email: att!hocpa!ewb  
work: (201) 834-1121  
Fax: (201) 834-1371  
home: (201) 957-0391

Several interesting things that I have learned since I received this letter... According to the guys at Yaesu, the engineers in Japan appearantly wrote the full UHF rx/tx out of the ROM on purpose.

The unit does a very good job as a cross-band repeater.

To enable this, turn off the radio, hold the RPT key and turn on the radio. Now, anything heard on EITHER band will be re-transmitted on the other band. There are, however, a few problems.

First, there is no real internal path for the audio to get from the receiver to the transmitter, so you either have to modify the radio, to provide a path, or do what I did which is build a short loop back cable connecting the tip of the earphone jack to the tip of the microphone jack like this:

<=====//=====>  
100K

This is the way I did it, others I have talked to have used either just a resistor like me or a small capacitor, or a combination. On my radio, this value of resistor gave me a good range of tranmitted audio levels by adjusting the volume control.

The other small problem is that the radio automatically selects low power on transmit in this mode. This is probably because of the lack of a real duplexer.

After looking through the service manual, it became appearant that the small mystery hole on the side of the radio with the rubber plug was originally intended for an external power jack. I have not yet asked Yaesu if they will sell the jack for that spot. I also have no idea why they omitted it.

All in all, I still love my FT-470. Its a great little radio.

--

Keith McQueen, Wicat Systems Inc. , (801)224-6400 | My opinions are |  
N7HMF @ NV7V.UT.USA.NA (84058), 147.34+, 449.675- | all mine... |  
UPLHERC!WICAT!KEITHM | ...so there! |

-----







Date: 6 Sep 90 12:47:28 GMT  
From: eru!hagbard!sunic!mcsun!ukc!stl!iclbra!icl!prs@bloom-beacon.mit.edu  
(Pete  
Subject: FT470 mods  
To: info-hams@ucsd.edu

Hello FT470 owners... I asked a few weeks ago about mods for the FT470 to make it receive and transmit on additional frequencies. I own(ed) the European version which caters for 144-146 & 430-440. It now transmits and receives 140-174 & 430-440, with additional receive coverage 440-500 MHz! The mod was fiddly as the chip resistors are the size of a pin head. You'll need a fine tipped soldering iron and about 2 hours of patience. Here's how I did it...

|                         |                  |              |
|-------------------------|------------------|--------------|
| For 2 metres..          | locate R66-69... | R69          |
| which are located at    | 10 O'clock       |              |
| to the lithium battery. |                  | R68-(lithium |
| R69 is vertical,        | R66-68 are       | R67-(battery |
| horizontal.             |                  | R66-(cell    |

The combination you want is: R66 & R68 = 0; R67 & R69 = 1.

Mine came with R66 & R69 set for Europe so I just moved the resistor from position R66 to position R67.

For UHF, locate R70-72 to the top left of the ribbon cable. These are vertical and in the order:

R71 R70 R72

The combination you want is: R71 & R70 & R72 = 0.

Mine came with R71 set for Europe so I just took the resistor out and have stuck it to the back of the battery (in case I need to convert back).

If anyone disagrees with these mods and think I've done something wrong, let me know a.s.a.p.

Cheers & 73  
de Peter G6ZYT.  
--

Pete Swynford is available... tel: +44 (344) 424842 x 2625  
or at prs@oasis.icl.stc.co.uk / ..!uunet!mcsun!ukc!iclbra!prs / G6ZYT@GB7RDG  
Disclaimer: See Paragraph 2.4.a of section 1.a (article 7) (iii) of the  
Town and Country Planning Act, 1967.

-----  
From bitlib@business.uwo.ca Wed Sep 26 10:48:37 1990  
From bitlib@business.uwo.ca Thu Sep 27 06:09:39 1990  
From bitlib@business.uwo.ca Sun Sep 30 12:57:34 1990



From elroy.jpl.nasa.gov!usc!rpi!gatech!usenet.ins.cwru.edu!neoucom.edu!wtm Sun  
Jan 10 22:05:48 PST 1993  
Article: 31591 of rec.radio.amateur.misc  
Newsgroups: rec.radio.amateur.misc  
Path: elroy.jpl.nasa.gov!usc!rpi!gatech!usenet.ins.cwru.edu!neoucom.edu!wtm  
From: wtm@uhura.neoucom.edu (Bill Mayhew)  
Subject: Re: Yaesu FT-5100 Help  
Message-ID: <1993Jan08.025302.22872@uhura.neoucom.edu>  
Organization: Northeastern Ohio Universities College of Medicine  
References: <1993Jan07.221614.29150@anomaly.sbs.com>  
Date: Fri, 08 Jan 1993 02:53:02 GMT  
Lines: 45

Tis easy to crossband repeat the 5100. Just hold down the RPT key while switching the power on (same as the 470-HT, I believe). A call to Yaesu (310-404-2700) yielded this info. According to Winston in tech support, this slipped out of the manual when it went to press. My 5100 didn't have any crossband info in the box, but an acquaintance said that his 5100 had an addendum slip packaged mentioning the RPT key trick.

Works quite nicely. One thing is that there is a lot of high frequency attenuation. I found that adding a 27K ohm resistor between the input and output leads of the data jack seems to clean up the sound (similar to a suggestion for audio improvement on the 470 HT). I used a variable pot and adjusted experimentally for best sound.

I really like my 5100. The in-band sensitivity is good. I've been lazy and haven't benched it at work yet. The 2m FM receive seems better than my Kenwood 751, which surprises me. Fortunately the 5100 does not get hammered with spurious signals in the 70 cm band the way the 530 HT does.

Here is a synopsis of how the 5100 receive (and probably transmit too) is easily expanded. I asked Winston to fax me the mod sheet (see above). The jumper change is pretty easy for a reasonably skilled solderer, but not for the neophyte. The rig is then reset with F/W-D/MR-REV keys while powering up. The upper/lower RX followed by upper/lower TX limits are then keyed in for each band. I've noticed that sensitivity in the expanded portions is less than in the amateur bands, but perfectly usable for copying weather stations, etc. Expanding the band seems to disable the ARS function, but I'd rather have the coverage since I memorized the band plans already.

I can't think of a good way to reproduce the mod drawing in ASCII, so I recommend calling them for the fax.

By the way, the 5100 service manual is not yet available. I've been on a waiting list for about three weeks, and I'm sure it'll be a while longer.

--

Bill Mayhew           NEOUCOM Computer Services Department

Rootstown, OH 44272-9995 USA phone: 216-325-2511  
wtm@uhura.neoucom.edu (140.220.1.1) 146.580: N8WED



Newsgroups: rec.radio.amateur.misc  
From: wtm@uhura.neoucom.edu (Bill Mayhew)  
Subject: Additional feature on Yaesu FT-5100 found: adjustable timeout  
Message-ID: <1993Feb07.170132.896@uhura.neoucom.edu>  
Organization: Northeastern Ohio Universities College of Medicine  
Date: Sun, 07 Feb 1993 17:01:32 GMT  
Lines: 32

I discovered by accidental application of fat finger: if the high/low button is held while turning on power, that transmitter time-out may be set. If you do this, the left VFO display will show some number between 00 and 60. The factory default appears to be 15. The number can be changed by rotating the frequency knob.

I tried an experiment, setting the number to 01. I keyed up into a dummy load. After one minute, the transmitter shut off with, "Err" displayed in the VFO.

I'll leave it up to you to decide a use for this feature. If you're an O.F. from HF that can't seem to break the habit of timing out repeaters, you could set your own time-out.

What would be neat would be to have a way to adjust RF power level in a similar fashion, but examining the schematic diagram, it looks like only two power levels are possible.

By the way, the technical manual for the 5100 is finally available. The information is pretty spare. No additional operating notes or hidden secrets are revealed. It is worthwhile for the alignment notes and complete parts list. Call the number in your owners manual to order.

73,  
Bill

--

Bill Mayhew           NEOUCOM Computer Services Department  
Rootstown, OH 44272-9995 USA   phone: 216-325-2511  
wtm@uhura.neoucom.edu (140.220.1.1)   146.580: N8WED



Newsgroups: rec.radio.amateur.misc  
From: brian@amdcl2.amd.com (Brian McMinn, N5PSS)  
Subject: Yaesu FT-5100/5200 mods  
Message-ID: <C5HDr6.E51@amdcl2>  
Originator: brian@minotaur  
Sender: news@amdcl2 (News System)  
Organization: Advanced Micro Devices, Inc., Austin, TX.  
Date: Wed, 14 Apr 1993 15:59:30 GMT  
Lines: 363

I've received many requests for the 5100/5200 mods, so I'm posting them. I'd like to get them onto an ftp site or two, but can't do that myself, so please e-mail me if you can do this for me. Thanks to the contributors and the folks who reviewed Rev A!

73, Brian

cut here...

-----  
Yaesu FT-5100/FT-5200 MODS  
Rev B (14 Apr 1993)

This is a collection of hardware and software mods for the Yaesu 5100/5200 pair. I have the 5100, so I can't verify these for the 5200. I have collected every mod seen on the net (ie. Usenet) since the introduction of the 5100, so I think this list is fairly complete. I am interested in getting updates and corrections to this list, so please send me e-mail if you find something that needs updating. (This includes typos, wrong or missing attributions, caveats, warnings about unmentioned side effects, serial numbers of radios that won't do some of these mods, etc.)

SOME OF THESE MODIFICATIONS MAY DAMAGE YOUR RADIO IF YOU PERFORM THEM IMPROPERLY. WHEN IN DOUBT, DO NOT PERFORM THE MODIFICATION.

This advice is free, so remember that you get what you pay for.

Brian McMinn (brian.mcminn@amd.com)  
N5PSS  
512-462-5389

-----  
Backlight Control:

Effect: manual control of backlight

- 1) Hold down the MHZ key and turn radio on
- 2) Use tuning knob to adjust brightness
- 3) When FUNC is active, the tuning knob will adjust brightness again.
- 4) You can restore automatic control by repeating step 1.



Notes: Manual is fuzzy on this feature.

Attributed: Yaesu

-----  
Crossband Repeat (reported as working on 5100 and 5200):

Effect: Enable crossband repeat

- 1) Dial up two frequencies you want to crosslink (be sure to pay attention to transmit offsets, if any)
- 2) Turn radio off.
- 3) Hold down the RPT key and turn radio on

Result: The tone encode/decode flags and the -+ flags will be flashing and the radio will be in low power mode. When either band's squelch opens, the other band is moved into the primary frequency display and the transmitter keys. Audio link appears to be speaker to mike.

Exit crossband repeat mode by repeating steps 2 and 3 above.

Attributed: Yaesu

-----  
Transmitter Timeout:

Effect: automatically limit transmitter "on" time

- 1) Hold down the HIGH/LOW button and turn radio on
- 2) Use tuning knob to change the number in left VFO. This number is number of minutes for the timeout timer. The factory default appears to be 15 minutes.
- 3) Transmitter shuts off with "Err" displayed in VFO if the time limit is exceeded.

Attributed: Bill Mayhew, N8WED, wtm@uhura.neoucom.edu

-----  
Crossband Audio Enhancement:

Effect: unmuffle crossband audio

Connect a 27K ohm resistor between the audio-in and audio-out leads on the data jack (inside the shell of a mini plug, that is). The mic element stays live while in xband operation. It is a good idea to remove the mic from the rig while crossbanding if you need/want to eliminate ambient audio.

Attributed: Bill Mayhew, N8WED, wtm@uhura.neoucom.edu  
-----

The "P" Key on the microphone:

I was curious about that "P" key on my FT-5100, so I called Yeasu and they explained the situation. They designed the mic to accommodate "future products". The "P" key is there to be taken advantage of at a later date by other models. They just did not want to re-design the mic again within a short period of time.

Attributed: Will Collier, KB5WRK, COLLIER@gallant.apple.com

-----  
Expanded Receive:

Good Effect: enable extended receive coverage  
                  New range: 128-180MHz and 420-475MHz  
Bad Effect: disable automatic repeater shift selection.

Warning: This mod does not apply to the FT-5200 as the design is somewhat different.

Warning: You must have a very steady hand or else! A magnifying glass would help too.

1) Disconnect DC Power cable from radio. ALWAYS!

**\*\*Caution\*\*** NEVER TRY TO TAKE APART (DISASSEMBLE) THE FRONT CONTROL HEAD. It will void your warranty.

- 2) Remove (6) screws from Top Cover of Radio and (6) screws from Bottom Cover of radio.
- 3) Remove Top & Bottom Covers from Radio (Be careful of speaker falling out).
- 4) Remove the (2) silver screws on each side of the radio holding front control head to main body of radio.
- 5) Carefully pull away (a few inches) the Control Head from the radio body. CAREFUL with the Ribbon Cables.

**\*\*NOTE\*\*** There are no numbers on the circuit board so you will have to match up with the diagram below.

- 6) On the rear of the Control head locate, Unsolder and remove jumper Pad R4072.
- 7) Solder across jumper pads: R4070 R4068 & R4064 (use wire or 0 Ohm resistor)

**\*\*NOTE\*\*** If you want to change the D/MR button on the microphone to do Band Switching, now is the time. See the next mod.

- 8) Install Front Control head, Speaker, Top and Bottom Covers and Reconnect Power to the Radio.
- 9) Press and hold [D/MR] [F/W] [REV] Keys and turn on the Radio. Radio will now show 300.000 & 20.000 on Display.
- 10) Set UHF Rx Low - Press [MHz] and dial 420.00, press [D/MR]



rather than D/MR function.

- 1-5) as in above mod
- 6) Remove the jumper on Pad R4067
- 7) skip above step 7
- 8) continue with step 8 above

Attributed: Tony Pelliccio, KD1NR system@garlic.sbs.com

-----

[end of mod sheet Rev B]

-----

Band Switching or Tone Burst via D/MR button on microphone (5200):

Effect: change function of D/MR button on mike.

This is based on information from Yaesu in Japan.

The functions of pin 5 (the microphone button) can be altered by changing jumpers in the control head. To find these jumpers, see the section on packet radio in the ordinary instruction book.

| Pin 5 Function     | Control Head Jumper No    |   |   |   |   |
|--------------------|---------------------------|---|---|---|---|
|                    | Closed Jumper Marked By X |   |   |   |   |
|                    | 1                         | 2 | 3 | 4 | 5 |
| D/MR               | X                         |   |   |   |   |
| Band               |                           | X |   |   |   |
| 1750Hz Tone Burst  | X                         | X |   |   |   |
| Main band Busy Out |                           |   |   | X |   |
| Sub band Busy Out  |                           |   |   | X |   |
| Call Channel       | X                         |   |   | X |   |

Main / Sub band busy out - When open SQL = 5 Volt DC  
Closed SQL = 0 Volt DC

[ed - I'm not sure what this means since I don't own a 5200]

Attributed: John Newgas, G7LTQ jnewgas@cix.compulink.co.uk,  
g7ltq@g7ltq.ampr.org

-----

Mute Level (5200):

Effect: [ed - I'm not really sure]

See above for location of jumpers, etc.

| Mute Level Selection | 1 | 2 | 3 | 4 | 5 |
|----------------------|---|---|---|---|---|
| No Mute              |   |   |   |   |   |
| Minimum              |   |   |   | X |   |
| Middle               |   |   |   |   | X |
| Maximum              |   |   |   | X | X |

Attributed: John Newgas, G7LTQ jnewgas@cix.compulink.co.uk  
g7ltq@g7ltq.ampr.org

-----  
Crossband Repeat (5200):

Effect: crossband repeater  
Bad effect: CTCSS function is lost

[ed -- there is another crossband mod in this list...]

This is based on information from Yaesu in Japan.

These jumpers are located in the main radio case. For location, refer to the FT5200 Technical Guide.

- 1) Remove (open) JP5017 on the interface unit
- 2) Press and hold PRI button while switching on the power.
- 3) The FT5200 will now work as a cross band repeater.
- 4) The CTCSS function will be lost.

Attributed: John Newgas, G7LTQ jnewgas@cix.compulink.co.uk  
g7ltq@g7ltq.ampr.org

-----  
Extended Frequency Range (5200):

Effect: set receive and transmit range.  
Bad effect: ARS gone.

This is based on information from Yaesu in Japan.

These jumpers are located in the main radio case. For location, refer to the FT5200 Technical Guide.

- 1) Close (short) JP5001, JP5002, JP5003, JP5006 and JP5007
- 2) Remove (open) JP5004 and JP5005

The frequency range possible will now be approximately :

|     |    |               |    |               |
|-----|----|---------------|----|---------------|
| VHF | Rx | 110 - 180 MHz | Tx | 130 - 180 MHz |
| UHF | Rx | 330 - 480 MHz | Tx | 425 - 465 Mhz |

The radio's alignment was done at the factory for your original frequency bands and so there will not be optimum behavior outside these ranges. Broadening the alignment will sacrifice performance at usual frequencies. In practice, the alignment does not need adjustment.

You can program the frequency limits now. [ed - note the similarity (and dissimilarity!) to the 5100's program-limit sequence above]

- 3) Press and hold [D/MR] [F/W] [REV] keys and turn radio on.
- 4) Program in VHF low edge of Rx

- VHF high edge of Rx
- VHF low edge of Tx
- VHF high edge of Tx
- 5) Repeat for UHF in the same order.

I [John] have not done this so I can give no further advice on programming.

Attributed: John Newgas, G7LTQ jnewgas@cix.compulink.co.uk  
g7ltq@g7ltq.ampr.org

-----  
Extended Frequency Range (5200):

[ed - yes, there are two mods and I include them both since they are so different in style (and perhaps content).]

Effect: set receive and transmit range.  
Bad effect: ARS gone.

The following explains how to expand the receive and transmit frequency range of the Yaesu FT-5200 and how to enable the cross-band repeater operation.

All the modifications are carried out on the interface board and involve removing or adding links on jumper spots.

You will get considerably increased receive and transmit coverage; however, you will lose the Automatic Repeater Shift (ARS) feature. You may think this is an acceptable price. Finally, it should be obvious, but during this procedure you will obviously lose any stored memories.

- 1) Remove the control head and set on one side
- 2) Remove the upper and lower covers on the main chassis. For convenience, remove the speaker, noting which way the two pin pcb connector is oriented. [ed -- does it matter?]
- 3) Remove two side screws holding on the front of the chassis and remove chassis front. (The chassis front is the surface with the contacts for the control head.)
- 4) Locate a double row of ten by two jumper spots, numbered 1 to 20. The jumper configurations will depend on the area for which the rig was intended. Note the arrangement if you ever want to un-modify your radio.
- 5) Using a fine-tip soldering iron, set the jumper spots as follows:

- 1 closed
- 2 closed
- 3 closed
- 4 open
- 5 closed
- 6 closed
- 7 closed

- 6) This completes the alteration for frequency expansion.

Reassemble the radio.

- 7) Reinitialise the radio by simultaneously holding D/MR, F/W, REV and POWER. You must now program in the band limits. The display will show a blinking "1" in the left-hand memory box and "000.000" in the left-hand frequency display. (Ignore the right-hand display for now). The following limits are suggested, but the RF circuitry of the rig will only cover slightly less. Use the dial or up/down buttons to select the frequency and then press D/MR to store it. The blinking "1" will increment.

VHF rx: 137.000 174.000  
VHF tx: 137.000 174.000  
(display will show blinking "1" and "300.000")  
UHF rx: 410.000 470.000  
UHF tx: 410.000 470.000

(Note: it is possible to set the RX limits wider than the TX limits; for obvious reasons you cannot have the reverse situation).

- 8) You can repeat step 7 above at any time if you need to change the limits.
- 9) The pre-set repeater offsets are now no longer available and you will have to set them up manually using the instructions on page 16 of the manual. The Automatic Repeater Shift (ARS) feature (also on page 16 of the manual) will also have disappeared and you will have no way of getting it back (except by changing the jumpers back).

To enable the crossband repeat, remove the link at jumper spot 17. (Note, just below jumper spot 17 is a separate jumper spot, not part of the group of twenty - leave this alone).

Attributed: Hugo Cornwall

-----

#### Cross Band Repeater (5200)

Effect: enable crossband repeat

[ed - this is a continuation of the above]

- 1) You can enable the crossband repeater without altering the frequency coverage. The only hardware alteration is the removal of link 17.
- 2) To enable, turn on rig while holding down [RPT] button. The rig is now a crossband repeater - you will get confirmation of this from the display: the 100s position on the two frequency displays will be replaced by a "R".
- 3) While in cross-band repeater mode you can change the frequencies of each band.
- 4) The crossband repeater suffers from desense. It works better at low power and even better if you use an external diplexer and separate antennas. The more isolation between

the two bands, the better. As with all cross-band repeaters, results will be poor if the UHF frequency is a direct multiple of the VHF frequency. If you are planning extended use of a crossband repeater, make extra sure that the rig is adequately ventilated.

=====

[end of mod sheet Rev C]

=====





Newsgroups: rec.radio.amateur.misc  
 From: byon@lynx.cecs.csulb.edu (Byon Garrabrant)  
 Subject: Yaesu FT-5100 CAT/Remote Control Mike Interface  
 Message-ID: <C69CuA.Cr@csulb.edu>  
 Sender: news@csulb.edu (News Administration/Rumor Bureau)  
 Organization: Cal State University, Long Beach  
 Date: Thu, 29 Apr 1993 18:32:33 GMT  
 Lines: 59

I own a FT-5100 and became interested in the Remote Control Mike, not for its wirelessness, but because it can control most of the radio's features via a serial data stream through the microphone jack. Although I do not own the wireless mike, I was able to build an interface between my PC and my 5100. It is somewhat similar to the CAT interface I have built for my FT-757 HF rig, but mostly like the interface described in the FT-912R manual (loaned to me via a friend from Yaesu). I have recently been working on a micro-controller based radio controller which I use for transmitter hunts, and other ham related activities, and I plan to allow it to control my 5100 soon, but so far I have only controlled the radio from my PC. When using my PC as the source for the serial data, I used a MAX232 chip for a level conversion between the +/- 12 volts levels on the computer and the 0-5 volt levels on the radio.

The serial data parameters are 4800 N82. The commands sent to the radio are simple one byte instructions. The RMC mode ON command (16) must be sent before any other command. When the RMC mode is ON, a small LCD "RMC" icon will light on the display (see owners manual under Display). Also, the Vol, Sql, and Bal knobs are disabled when in the RMC mode because they will be controlled via serial commands, but all other buttons are still active.

The commands are as follows:

|          |           |                |
|----------|-----------|----------------|
| 0 - RPT  | 12 - CALL | 24 - SQL Up    |
| 2 - REV  | 14 - BAND | 26 - VOL Up    |
| 4 - MHZ  | 16 - RMC  | 28 - BAL Right |
| 6 - D/MR | 18 - SUB  | 30 - BAL Left  |
| 8 - TONE | 20 - PAGE | 32 - SQL Down  |
| 10 - LOW | 22 - F/W  | 33 - VOL Down  |

The interface I built simply wired mike port pin 7 to serial ground and pins 1 and 3 each through a diode then together, to the serial source. Note: I am not a hardware person! Use this hardware at your own risk.

```

+----1 7----- GND
|   2 8 6
| +--3 5  +----- SER IN  (These can be connected to a MAX232
| |   4   | |              or the FIF-232C pins 1 and 3)
| +---->|----+ |
+----->|-----+
  
```

You can wire 1 and 3 together first, then through 1 diode, but that disables the UP and DOWN buttons.

I will continue to study this more. If anyone would like to know more, or has any corrections or feedback, please email me.

73 Byon

-----  
Byon Garrabrant

KD6BCH

byon@csulb.edu  
-----

--

Byon Garrabrant KD6BCH byon@csulb.edu



From: wa2ise@cbnewsb.cb.att.com (robert.f.casey)  
Newsgroups: rec.radio.amateur.misc  
Subject: FT5200 crossband mod file  
Keywords: mods  
Message-ID: <1991Oct13.200102.5046@cbfsb.att.com>  
Date: 13 Oct 91 20:01:02 GMT  
Sender: news@cbfsb.att.com  
Organization: AT&T Bell Laboratories  
Lines: 60

copied from packet:  
From: n2fwq@wb2gtx.nj.usa.na (DANIEL)  
To: mods@allbbs  
#Subject: ft5200 crossband mods

Tony Lessing KA3KVD 76474,2051  
Ken Hoehn/N8NYO [SysOp] 73670,3622

the mod for the FT5200 cross band mod. It goes as follows:

1. Disconnect DC power from radio.
2. Unlatch and remove the front control head. !Do not take apart the control head or the warranty will go \*VOID\* :-)
3. Remove (6) screws from top cover of radio.
4. Remove (6) screws from bottom cover of radio.
5. Remove top and bottom cover.. being careful of the speaker that will want to fall out.
6. Remove the (2) silver screws (on each side of radio) holding front control head mounting plate to main body of radio. Remove the front mounting plate.
7. Locate and unsolder jumper pad 17.
8. Install the front mounting plate, and top and bottom covers.
9. Reconnect power.... you're ready to go..

10. To put in xband repeat press and hold the RPT key while turning on the radio. To stop... turn off the radio.

!! note !! It is suggested to disconnect the mic when in xband repeat, as it will be "hot". Adjust the volume knob for the desired repeat audio level.

Cheers, de Tony - KA3KVD

There is 1 Reply.

Regarding .... Jumper Pad 17 ....

This might seem confusing when first viewing the jumper pads... they are to the right of the 5\_strip connector for the face plate and are numbered as follows

```
.. 20 18 16 14 12 10 8 6 4 2  
.. 19 17 15 13 11 09 7 5 3 1
```

You will see that the number 17 is lower than the rest and that there are 2 pads above it... one in line with all the others (this is the correct one) and one that is horizontal and just above the number "17" (this should be left alone)

73 ... Tony

It is a bit rough cross-band repeating two repeaters (hardly efficient use of spectrum, now isn't it? (Honest..just testing)

Also, there are certain frequency combinations that just don't work, and others that require one, the other, or both sides to transmit at low power.

Nice toy...now, a practical application???

Ken :)

-----  
Note: I haven't tried or verified this, proceed at your own risk. WA2ISE

From: wa2ise@cbnewsb.cb.att.com (robert.f.casey)  
Newsgroups: rec.radio.amateur.misc  
#Subject: FT5200 mods (wideband rx/tx, crossband repeater operation  
Keywords: mod file  
Message-ID: <1991Nov3.210959.28264@cbfsb.att.com>  
Date: 3 Nov 91 21:09:59 GMT  
Sender: news@cbfsb.att.com  
Organization: AT&T Bell Laboratories  
Lines: 40

copied from packet:

| Msg#  | TSF | Size | #Rd | Date   | Time | From  | MsgID       | To              |
|-------|-----|------|-----|--------|------|-------|-------------|-----------------|
| 63936 | BN  | 2529 | 0   | 27-Oct | 1849 | F6DWP | 61195_F6KDJ | YAESU@WW (NONE) |

Dual Bander YAESU FT-5200 Modifications for wideband RX/TX VHF/UHF coverage and Cross-band Repeater operation.

=====  
=

First locate the 20 jumpers on the control Unit of the FT-5200.  
Then short jumpers 1-2-3-6-7 .  
Some jumpers are still shorted depending upon the country version.  
Remove the Jumper number 17 for cross-band operation .  
For resetting the unit press D/MR -- F/W -- REV buttons in the same time and switch on the transceiver.  
The display must show now 300.000 on the right and 000.000 on the left .  
You must now program the lower and upper bands limits on RX and TX as follows:  
After resetting the channel number digit on the left of the display is showing a ""1"" blinking ..  
With the vfo knob and the MHZ button increment from 000.000 to the desired lower VHF frequency with 1 Mhz steps . The press the D/MR button to lock the frequency . Now the channel digit shows a blinkin""2"". Increment the display to obtain the VHF upper limit . Press again D/MR to lock the frequency and obtain a ""3"" digit channel blinking .. Increment the display value with the vfo knob to fix the TX VHF lower limit . Push D/MR to lock the frequency . The digit channel is blinking with number ""4"" and program the upper TX transmit limit . Press again D/MR , the display is now reversed from left to right and program the UHF TX/RX limits with the same procedure used for teh VHF band.

-----  
For cross-band operation , press the RPT button when switchching ON the  
tranceiver . Adjust the audio level with the volume control and balance .  
-----

For wideband Uhf RX operation the frond end coils with metallic cores  
must be realigned to spread the sensitivity of the receiver. A swept  
oscillator with scope should be employed eventually .

73's from F6DWP  
=====

=

Note: I haven't tried or verified this, proceed at your own risk. WA2ISE





From amdcl2!amdcl2!brian@amd.com Wed Apr 14 14:15:29 1993  
From: amdcl2!brian@amd.com (Brian McMinn)  
Subject: FT 5200A Mod

-----  
Yaesu FT-5100/FT-5200 MODS  
Rev B (14 Apr 1993)

This is a collection of hardware and software mods for the Yaesu 5100/5200 pair. I have the 5100, so I can't verify these for the 5200. I have collected every mod seen on the net (ie. Usenet) since the introduction of the 5100, so I think this list is fairly complete. I am interested in getting updates and corrections to this list, so please send me e-mail if you find something that needs updating. (This includes typos, wrong or missing attributions, caveats, warnings about unmentioned side effects, serial numbers of radios that won't do some of these mods, etc.)

SOME OF THESE MODIFICATIONS MAY DAMAGE YOUR RADIO IF YOU PERFORM THEM IMPROPERLY. WHEN IN DOUBT, DO NOT PERFORM THE MODIFICATION.

This advice is free, so remember that you get what you pay for.

Brian McMinn (brian.mcminn@amd.com)  
N5PSS  
512-462-5389

-----  
General Review (5100):

Since Yaesu's advertising has already made the good points known, I'll concentrate on the warts and shortcomings.

Dual In-Band Receive: works as advertised except for sensitivity. The "main" receiver works very well. The "sub" receiver works very well when tuned to the opposite band from the "main" receiver. When tuned to the same band, the "sub" receiver suffers from slightly lower sensitivity in the ham bands and greatly reduced sensitivity out of the ham bands.

There is a 2m VCO/PLL/IF and a 70cm VCO/PLL/IF. I assume that dual in band receive is done with the opposite band's receiver. This would explain the poor sensitivity, but it sure raises some questions about how the duplexer works.

I expected a type "N" connector, the radio came with UHF.

Control wart: (are you listening Yaesu?) You can only transmit on the "main" (ie. left) side of the radio. When both 2m and 70cm receive are active, you change bands with the

"BAND" button. This swaps the left and right displays. When dual in-band receive is active, the "BAND" button changes both the main and sub receivers from 2m to 440 or from 440 to 2m. Arrrgh!!!! I would prefer a "SWAP" button to swap left and right regardless of mode. (The "SUB" button is used instead.)

Automatic backlight dim: works as advertised but the backlight level under low ambient lighting is WAY too low. Manual control is the best solution.

DTMF page: works as advertized, but the \*%\$#@ thing insists on "ringing" like a phone EVERY time it receives the page sequence. This means that you have to co-ordinate with the other station to turn the \*%\$#@ DTMF stuff off at the same time or tolerate the "ring" at the start of every receive.

CTCSS decode: squelch opens quickly when normal CTCSS decode (an option) is enabled. There is a CTCSS page function that has a distinct delay between receipt of carrier with CTCSS and open squelch. I don't yet understand the use of this "feature."

There is no SCAN button on the front panel. Scan is initiated by holding the up or down button of the mike down for two seconds. The scan is blindingly fast when compared to the Alinco 590 that I used to have.

Memory: memory is divided into four "banks." Two for VHF, two for UHF. Only one bank can be active for each receiver. I consider this an advantage, but you may not. There are two obvious (to me) uses for this configuration. First, you can store frequencies for different uses in different banks. Second, you can activate one 2m(440) bank in the main receiver and one the other 2m(440) bank in the other receiver and scan them simultaneously.

Heat management: After seeing the HUGE heat sink on the back of the Alinco 590, the Yaesu 5100's sink seems too small. In a key down experiment, the heat sink of the Yaesu got almost too hot to touch before the fan kicked on. If I were planning to run a packet station, I would definitely look into some extra forced air over the back of this one. As it is, I'm a bit concerned about how hot it will get mounted in my dashboard. [Others people don't seem to have this problem.]

DTMF Decode and Scan: If you have CTCSS decode (an option) enabled on a memory and you are scanning and there is activity on that frequency but without the correct CTCSS tone, the 5100 stops scan, flashes the strength meter and then continues scanning. It is slower than normal scan, but still quite fast.

Attributed: Brian McMinn, N5PSS, brian.mcminn@amd.com

-----  
Backlight Control:

Effect: manual control of backlight

- 1) Hold down the MHZ key and turn radio on
- 2) Use tuning knob to adjust brightness
- 3) When FUNC is active, the tuning knob will adjust brightness again.
- 4) You can restore automatic control by repeating step 1.

Notes: Manual is fuzzy on this feature.

Attributed: Yaesu

-----  
Crossband Repeat (reported as working on 5100 and 5200):

Effect: Enable crossband repeat

- 1) Dial up two frequencies you want to crosslink (be sure to pay attention to transmit offsets, if any)
- 2) Turn radio off.
- 3) Hold down the RPT key and turn radio on

Result: The tone encode/decode flags and the +- flags will be flashing and the radio will be in low power mode. When either band's squelch opens, the other band is moved into the primary frequency display and the transmitter keys. Audio link appears to be speaker to mike.

Exit crossband repeat mode by repeating steps 2 and 3 above.

Attributed: Yaesu

-----  
Transmitter Timeout:

Effect: automatically limit transmitter "on" time

- 1) Hold down the HIGH/LOW button and turn radio on
- 2) Use tuning knob to change the number in left VFO. This number is number of minutes for the timeout timer. The factory default appears to be 15 minutes.
- 3) Transmitter shuts off with "Err" displayed in VFO if the time limit is exceeded.

Attributed: Bill Mayhew, N8WED, wtm@uhura.neoucom.edu

-----  
Tech Manual:

The technical manual for the 5100 is [information wise] pretty spare. No additional operating notes or hidden secrets are revealed. It is worthwhile for the alignment notes and complete parts list. Call the number in your owners manual to

order.

Attributed: Bill Mayhew, N8WED, wtm@uhura.neoucom.edu

---

DTMF decoding:

Effect: display decoded DTMF tones

Note: this works on the related FT-530, but not on my 5100. I'm including it here on the chance that it works on the 5200. Please try it on your 5200 (or 5100) and tell me if it works for you.

- 1) Select frequency and turn on the code squelch
- 2) Press Function-Page(Code) to select a code memory
- 3) Dial up to memory #7 [the 5100 won't do this]
- 4) Watch the dtmf's scroll by as they are heard by the radio!

Attributed: jmeyers@ecst.csuchico.edu (Jeff Meyers)

---

Crossband Audio Enhancement:

Effect: unmuffle crossband audio

Connect a 27K ohm resistor between the audio-in and audio-out leads on the data jack (inside the shell of a mini plug, that is). The mic element stays live while in xband operation. It is a good idea to remove the mic from the rig while crossbanding if you need/want to eliminate ambient audio.

Attributed: Bill Mayhew, N8WED, wtm@uhura.neoucom.edu

---

Wireless Mike (review):

The wireless mike sends audio over 49.85MHz, so it is can't be used in high RF environments (like near computers). It duplicates ALL front panel controls with the exception of the power button.

It interfaces to the rig via a standard mic plug. The receiving unit is only about 1'h x 2w x 1/2d.

[ed] The implications of this are that the entire radio can be controlled via the microphone port! Too bad there isn't a fancy \*wired\* mike with all the controls on it.

Several people have reported trouble with the mike -- enough trouble for them to return it because of poor range and poor audio. It works well if you sit on top of the pickup unit, but then you don't need a wireless mike.

Attributed: Tony Pelliccio, KD1NR system@garlic.sbs.com

-----  
The "P" Key on the microphone:

I was curious about that "P" key on my FT-5100, so I called Yeasu and they explained the situation. They designed the mic to accomodate "future products". The "P" key is there to be taken advantage of at a later date by other models. They just did not want to re-design the mic again within a short period of time.

Attributed: Will Collier, KB5WRK, COLLIER@gallant.apple.com

-----  
Expanded Receive:

Good Effect: enable extended receive coverage

                  New range: 128-180MHz and 420-475MHz

Bad Effect: disable automatic repeater shift selection.

Warning: This mod does not apply to the FT-5200 as the design is somewhat different.

Warning: You must have a very steady hand or else! A magnifying glass would help too.

1) Disconnect DC Power cable from radio. ALWAYS!

**\*\*Caution\*\*** NEVER TRY TO TAKE APART (DISASSEMBLE) THE FRONT CONTROL HEAD. It will void your warranty.

2) Remove (6) screws from Top Cover of Radio and (6) screws from Bottom Cover of radio.

3) Remove Top & Bottom Covers from Radio (Be careful of speaker falling out).

4) Remove the (2) silver screws on each side of the radio holding front control head to main body of radio.

5) Carefully pull away (a few inches) the Control Head from the radio body. CAREFUL with the Ribbon Cables.

**\*\*NOTE\*\*** There are no numbers on the circuit board so you will have to match up with the diagram below.

6) On the rear of the Control head locate, Unsolder and remove jumper Pad R4072.

7) Solder across jumper pads: R4070 R4068 & R4064 (use wire or 0 Ohm resistor)

**\*\*NOTE\*\*** If you want to change the D/MR button on the microphone to do Band Switching, now is the time. See the next mod.

- 8) Install Front Control head, Speaker, Top and Bottom Covers and Reconnect Power to the Radio.
  - 9) Press and hold [D/MR] [F/W] [REV] Keys and turn on the Radio. Radio will now show 300.000 & 20.000 on Display.
  - 10) Set UHF Rx Low - Press [MHz] and dial 420.00, press [D/MR]
  - 11) Set UHF Rx High- Press [MHz] and dial 475.00, press [D/MR]
  - 12) Set UHF Tx Low - Press [MHz] and dial 420.00, press [D/MR]
  - 13) Set UHF Tx High- Press [MHz] and dial 450.00, press [D/MR]
  - 14) Set VHF Rx Low - Press [MHz] and dial 128.00, press [D/MR]
  - 15) Set VHF Rx High- Press [MHz] and dial 180.00, press [D/MR]
  - 16) Set VHF Tx Low - Press [MHz] and dial 140.00, press [D/MR]
  - 17) Set VHF Tx High- Press [MHz] and dial 150.00, press [D/MR]
  - 18) Set UHF offset - Press [F/W] then [RPT] dial 5.000 press [RPT]
  - 19) Set UHF tuning - Press [F/W] then [REV] dial 25.0 press [RPT]
  - 20) Set VHF offset - Press [F/W] then [RPT] dial 0.600 press [RPT]
  - 19) Set VHF tuning - Press [F/W] then [REV] dial 20.0 press [RPT]
- (VHF tuning step varies by state -- many use 15.0)

Diagram: [there are no tabs in this section - ed]

Ok, here's where it gets tricky, but so you know, a '|' represents a jumper.

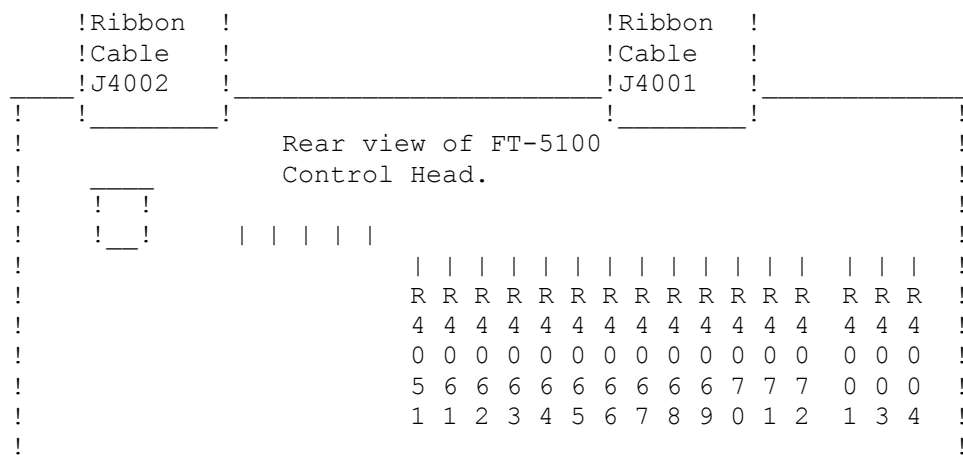

| Stock US Jumpers | After Mod. Jumpers     |
|------------------|------------------------|
| R4001            | R4001                  |
| R4003            | R4003                  |
| R4004            | R4004                  |
| R4051            | R4051                  |
| R4061            | R4061                  |
| R4062            | R4062                  |
|                  | R4064                  |
| R4067            | <- for D/MR button mod |
|                  | R4068                  |
|                  | R4070                  |
| R4072            |                        |

This mod is on Delphi as FT5100.MOD and on anomaly.sbs.com.

Attributed: Tony Pelliccio, KD1NR system@garlic.sbs.com

-----  
Band Switching via D/MR button on microphone:

Effect: D/MR button on microphone performs band switching rather than D/MR function.

- 1-5) as in above mod
- 6) Remove the jumper on Pad R4067
- 7) skip above step 7
- 8) continue with step 8 above

Attributed: Tony Pelliccio, KD1NR system@garlic.sbs.com

-----  
[end of mod sheet Rev B]  
-----







12 (|) (|) 11  
14 (|) (|) 13  
16 (|) (|) 15

-

In side the rig, it really did not look quite like that ... more like this:

... 12 (|) (|) 11  
          (|) 13  
      16 (|) (|) 15

In addition to the published receive expansion, it also receives 800-950 MHz...  
trunking radio, cell phone (I would \*never\* listen to that), 33cm ham band...

Have fun!

/-----  
| Jeff Otterson | The opinions expressed here are |  
| j\_otterson@star.enet.dec.com | mine. Noone else should be held |  
| Digital Equipment Corporation | responsible for my actions. |  
| 110 Spit Brook Rd. Nashua, NH | CENSORSHIP IS THE TOOL OF TYRANTS |  
-----/



From: wa2ise@cbnewsb.cb.att.com (robert.f.casey)  
Newsgroups: rec.radio.amateur.misc  
Subject: FT650 noise blanker mod file  
Keywords: mods  
Message-ID: <1992Apr25.025655.16102@cbfsb.cb.att.com>  
Date: 25 Apr 92 02:56:55 GMT  
Sender: news@cbfsb.cb.att.com  
Organization: AT&T  
Lines: 17

copied from packet:

| Msg# | TSF | Size | #Rd | Date   | Time  | Arrived | Seq #                  | Msg ID | Route |
|------|-----|------|-----|--------|-------|---------|------------------------|--------|-------|
| 414  | BF  | 2796 | 0   | 15-Apr | 1244z | 24-Apr  | (24686 - 39393_VK4AFS) | [ ]    |       |

VK4TUB ==> MODS@WW  
"FT650 NOISE BLANKER MOD"  
From: VK4TUB@VK4AFS.#NQ.QLD.AUS.OC  
To: VHF6@ASIA

If you are unhappy with your FT650 noise blanker here is a quick mod.  
The mod involves shorting diode 4013 which will increase the gating  
time of the agc line to the noise blanker.  
This is located on the if board.  
This will improve the noise blanking by several S points under heavy  
power line noise.  
73,S VK4TUB.

=====  
Note: I haven't tried or verified this, proceed at your own risk. WA2ISE



Newsgroups: rec.radio.amateur.misc  
From: little@nuts2u.enet.dec.com (nuts2u::little)  
Subject: Re: Mods for ft726r to do 9600  
Message-ID: <1993May12.183242.8842@nntpd2.cxo.dec.com>  
Sender: usenet@nntpd2.cxo.dec.com (USENET News System)  
Organization: Digital Equipment Corporation  
References: <jjkUs\*pC2@lemsys.UUCP>  
Date: Wed, 12 May 1993 20:32:28 GMT  
X-Posted-Via: NEWS-NOTES gateway (a hack!)  
Lines: 19

From James Miller G3RUH:

Inject your modem TXaudio directly to the transmitter varactor in the SAT unit via J04 pin 2.

1. Remove the main lid; remove the SAT unit lid.
2. Locate J04 which is a 3 wire connector in the front left-hand corner.
3. Unplug J04, and inject your audio on pin 2, ground on pin 1, using a screened cable.

This is of course assuming you are using a G3RUH or K9NG 9600 baud FSK modems. The receive side needs to come straight from the discriminator which I haven't had a chance to locate yet. Perhaps if someone else has the necessary hook up information for the receive side, they could post it here.

73,  
Todd  
N9MWB



From: bitlib@business.uwo.ca Tue Nov 27 15:47:14 1990  
Subject: FT727R MODS

=====  
==

From: <REID@IUBACS.BITNET>  
To: MBRAMWEL@BUSINESS.UWO.CDN

YAESU FT-727R

Modification for extended coverage. (This will work for both the old  
and new CPU versions)

- Remove the battery pack
- locate the RAM backup switch according to your manual ( this  
will be the switch FARTHEST away from the battery terminals)
- Turn the switch off, count to 4, then turn it back on
- Relace the battery pack
- Turn the rig on. The readout should be entirely blank. If it  
is not, you probably did not wait long enough before turning  
the switch back ON, so repeat the above procedure.
- Type in the following: " 001111 "
- The rig should now come to life. You will have to reprogram  
all the memories as well as the repeater splits for both  
bands. The display will now cover 100-199, 400-499MHz, but  
it obviously won't work over this range. Mine covers 139-  
160, 420-460. The reset code will be " 007777" ( I haven't  
tried it)

Good Luck. Tim Pacan VE300Z  
[source: rec.ham-radio]





Date: 5 May 89 16:48 PST  
From: ALLYN@SLACVM.BITNET  
To: MBRAMWEL@UWO.CDN  
Subject: ft727r CAT interface

## FT-727R CAT System Interfacing and Control

This information describes the hardware and software requirements of the CAT (Computer Aided Tranceiver) System in the FT-727R.

### Connections

Four connections are used by the CAT SystemL three at the CAT jack, illustrated below, and one (Signal Ground) at the outer contact of the MIC or EAR jack.

DO NOT SHORT THE OUTER CONTACT OF THE CAT JACK TO GROUND!!!

[Diagram of the CAT plug:

Looks like a stereo audio jack of the appropriate size.

The outer sleeve is +6 to +12 V DC (Battery Voltage) I do not think this line needs to be connected.

The middle contact is the Serial KeyCode Input.

The center contact is the Serial Meter Output (00h to 0Fh).

See the manual for further description.]

### Data Format:

All serial data consists of single byte binary codes sent at 4800 baud, TTL levels, with two INVERTED stop bits and one INVERTED start bit.

### Key Codes:

CAT Control consists of duplication the keystrokes that can be made on the tranceiver keypad by sending the corresponding keycodes to the Serial KeyCode Input contact of the CAT jack. The most significant four bits (MSD) correspond with the key column and the least significant four bits (LSD) correspond with the key row. The Function key (on the side of the tranceiver) is simulated by setting bit 7. Results are identical to those described for manual operation in the FT-727R Operating Manual. Serial Meter Output is sent approximately every 100 ms while receiving.

[Table for the codes. The lines in [] are the original values in the Yaesu handout, and are followed by the corrected lines as determined by KB7ABA. Remove the lines in [] to see what should be the right table.]

[ [ FUNC F E D C B ]

|     |        |   |   |   |   |     |
|-----|--------|---|---|---|---|-----|
|     | [ FUNC | 8 | 9 | A | B | C   |
| MSD | [      |   |   |   |   |     |
|     | [ NORM | 7 | 6 | 5 | 4 | 3 ] |
|     | [ NORM | 0 | 1 | 2 | 3 | 4   |

LSD  
V

|   |       |       |       |      |       |
|---|-------|-------|-------|------|-------|
| E | +RPT  | SIMP  | -RPT  | PMS  | P SET |
|   | 1     | 2     | 3     | V    | c     |
| D | SAV T | T DEC | T SET | TX M | S/CH  |
|   | 4     | 5     | 6     | M    | MR    |
| B | SAVE  | T ENC | SCAN  | MC   | Shift |
|   | 7     | 8     | 9     | C    | <=>   |
| 7 | LOCK  | BATT  | BEEP  | DUP  | Step  |
|   | *     | 0     | #     | V/U  | D     |



From: <REID@IUBACS.BITNET>  
To: MBRAMWEL@BUSINESS.UWO.CDN

Subject: YAESU FT-727R

Modification for extended coverage. (This will work for both the old and new CPU versions)

- Remove the battery pack
- locate the RAM backup switch according to your manual ( this will be the switch FARTHEST away from the battery terminals)
- Turn the switch off, count to 4, then turn it back on
- Relace the battery pack
- Turn the rig on. The readout should be entirely blank. If it is not, you probably did not wait long enough before turning the switch back ON, so repeat the above procedure.
- Type in the following: " 001111 "
- The rig should now come to life. You will have to reprogram all the memories as well as the repeater splits for both bands. The display will now cover 100-199, 400-499MHz, but it obviously won't work over this range. Mine covers 139-160, 420-460. The reset code will be " 007777" ( I haven't tried it)

Good Luck. Tim Pacan VE300Z  
[source: rec.ham-radio]



From: gopstein@helix.squibb.com (Rich Gopstein)  
Newsgroups: rec.ham-radio  
Subject: FT736 2m RX mod!  
Date: 15 Jan 91 15:17:09 GMT  
Sender: news@soleil.UUCP  
Organization: Bristol-Myers Squibb PRI, Lawrenceville, NJ  
Lines: 37

I found this on Compuserve. I tried it on my FT736, and it works! I wonder what the other diodes do? Does anyone have a service manual for the FT736?

Fm: Chuck Scott N8DNX 76556,3335

You can modify the 2 Meter section for 141-154 MHZ by adding D27 (not installed in USA version). This is normally soldered to the board but you can easily install it by simply shoving the leads into the connector. The 2 Meter section is the middle board looking into the radio from the top. The connector (J09) is the large one on the right side of the board, half way back. You want the cathode (striped end) of a small signal diode in pin 7 and the anode in pin 4. Pin 1 is toward the front of the radio.

To receive over a slightly wider range, place the SAT switch in RX mode, press ENT[D] then enter a desired frequency and press ENT[D] again. You can enter any frequency from 100 to 200 MHz this way. Unfortunately, the synthesizer does not actually cover that range. As far as I can tell the bottom end is about 138.5 (not quite the 136.5 needed for the weather sats). The top end is about 155.6. You can't perform this stunt with the normal (non-satellite) VFO's. Also, once a frequency is entered in this way, it is possible to tune toward the normal range but tuning away will place you back in the 141-154 range. Using the same method yields aprox 220.0-229.5 & 423.0-454. You may store these frequencies in the SAT Memories.

Chuck

--

Rich Gopstein  
gopstein@squibb.com  
rutgers!squibb.com!gopstein





Newsgroups: rec.radio.info  
From: wa2ise@cbnewsb.cb.att.com (robert.f.casey)  
Subject: FT747 mod file  
Message-ID: <1993Jan24.010205.6043@cbfsb.cb.att.com>  
Keywords: mods  
Sender: news@cbfsb.cb.att.com  
Organization: AT&T  
Date: Sun, 24 Jan 1993 01:02:05 GMT  
Approved: wa2ise@cbnewsb.cb.att.com  
Lines: 32

copied from packet:

| Msg#  | TSF | Size | #Rd | Date   | Time | From  | MsgID       | To          |
|-------|-----|------|-----|--------|------|-------|-------------|-------------|
| 32967 | BF  | 2113 | 0   | 13-Jan | 1136 | F1LOU | 30521_ON7RC | YAESU@WW () |

Sb: FT747GX MODS

---

GENERAL COVERAGE MOD FOR YAESU FT-747GX

---

- 1.) Remove top cover like explained in your OPERATING MANUAL.
- 2.) On backside of display unit there is a brown jumper wire near the large ribbon cable.
- 3.) Cut this jumper wire.
- 4.) Turn radio on and set display for 12.345.6 and then turn radio off and then back on.
- 5.) This enables the general coverage mode and a GEN display will appears on at the top of the LCD display.
- 6.) Reassemble the unit. It will now transmit between 1.5 and 30 MHZ.

73's de Phil, F1LOU @ ON7RC.BT.BEL.EU

=====  
Note: I haven't tried or verified this, proceed at your own risk. And  
DO NOT transmit outside of legal bands! WA2ISE



Date: Sat, 29 Jul 89 09:55:06 edt  
Reply-To: PZS@mercury.mceo.dg.com  
From: Pete\_Simpson@dgc.mceo.dg.com  
Subject: General coverage mod for YAESU FT-747GX

CEO file contents:

---

General Coverage Mod for YAESU FT-747GX

---

- 1) Remove top cover.
- 2) On backside of display unit, there is a brown jumper wire near the large ribbon cable.
- 3) Cut the brown jumper wire.
- 4) Turn the radio on and set the frequency to 12,345.6 KHz, then turn the radio off, then on again.
- 5) This enables the general coverage mode and a GEN display will come on and stay on at the top of the LCD display.
- 6) Reassemble the unit. It will now transmit everywhere it receives, however, Yaesu recommends that it only transmit between 1.8 - 30 MHz.

Disclaimer: I'm passing this on from someone who owns one of these and has done the mod. I have not done or tested this mod. You do it at your own risk.



From: wa2ise@cbnewsb.cb.att.com (robert.f.casey)  
Newsgroups: rec.radio.info  
Subject: FT757 mod file GX and GXII  
Keywords: mods  
Message-ID: <1993Jan24.011132.6430@cbfsb.cb.att.com>  
Date: 24 Jan 93 01:11:32 GMT  
Sender: news@cbfsb.cb.att.com  
Organization: AT&T  
Lines: 26  
Approved: wa2ise@cbnewsb.cb.att.com

copied from packet:

| Msg#                      | TSF | Size | #Rd | Date   | Time | From  | MsgID       | To          |
|---------------------------|-----|------|-----|--------|------|-------|-------------|-------------|
| 32969                     | BF  | 1796 | 0   | 13-Jan | 1138 | F1LOU | 30523_ON7RC | YAESU@WW () |
| Sb: FT757GX and GXII MODS |     |      |     |        |      |       |             |             |

YAESU FT757GX and GXII - TX 1,5 to 30 MHZ.  
=====

- Disconnect FT757 from all connections.
- Open tranceiver like explained in your "OPERATING MANUAL".
- Locate on the "CONTROL UNIT" SW03 and change its position.
- Close tranceiver back and reconnect power.
- This give you 100w between 1,5 and 30 mhz.

73's de Phil, F1LOU @ ON7RC.BT.BEL.EU  
=====

Note: I haven't tried or verified this, proceed at your own risk. And  
DO NOT transmit outside of legal bands! WA2ISE



Newsgroups: rec.radio.amateur.misc  
From: cook@stout.atd.ucar.edu (Forrest Cook)  
Subject: Re: How to broadband a Yaesu FT-757GXII?  
Message-ID: <1992Nov4.045408.8975@ncar.ucar.edu>  
Sender: news@ncar.ucar.edu (USENET Maintenance)  
Organization: Atmospheric Technology Division/NCAR Boulder, CO  
References: <1992Nov4.013124.22012@ncar.ucar.edu>  
Distribution: usa  
Date: Wed, 4 Nov 1992 04:54:08 GMT  
Lines: 14

In article <1992Nov4.013124.22012@ncar.ucar.edu> cook@stout.atd.ucar.edu  
(Forrest Cook) (me) writes:  
>Does anybody have information on how to "broadband" a Yaesu FT-757GX II  
>transceiver?

Just after posting the article a friend of mine came in and he found  
the unmarked switch on the upper main board near the display board and  
under a bundle of wires.

- 1: remove the top cover
- 2: locate the small black switch that is located on the edge of the  
big horizontal board near the back of the main tuning dial. The switch  
was under a bundle of wires. You do not need to remove the metal cover  
from the board.
- 3: flip the switch.
- 4: replace the top cover.

Forrest Cook  
cook@stout.atd.ucar.edu WB0RIO  
[husc6|rutgers|ames|gatech]!ncar!stout!cook





Subject: YAESU FT767GX mod  
Message-ID: <8908221542.AA00047@adam.DG.COM>  
From: Kendell\_Chilton@dgc.mceo.dg.COM  
Date: 22 Aug 89 14:42:58 GMT

I have recently purchased the aforementioned transceiver. I have had no problems to speak of and enjoy the rig thoroughly. I would like to submit the following mod for the rig. Note that implementation on this mod is at the rig owner's risk and may violate warranties. Here is a description of the mod:

- o Remove the bottom cover (8 screws: 4 underneath, 2 on each side)
- o Remove the plastic rear panel. (Just a cosmetic piece)
- o Remove the rear metal panel. (So many screws)
- o Loosen the "hinge" screws on the front bottom. There are 4 of them.
- o Lift the now loose card tray to expose to inner circuit boards. Be careful! There are two power supply lines that need to be disconnected. (Remember to reconnect them on assembly.) (one is the control board, the other the one we want.) Note that the board we will mod is the same one that has the switch that allows changing the tuning dial from 5kHz/rev to 10kHz/rev.
- o Change the position of switch S01. The rig will now transmit from 1.5 to 29.99999 MHz.
- o Reverse the disassembly procedure.

Well that's it. You are now ready for any band addition that may come our way. If you have problems, reply; I'll try to answer your questions.

73s de KA1TIH : Kendell\_Chilton@dgc.mceo.dg.com (Ken Chilton)



Newsgroups: rec.radio.info  
From: wa2ise@cbnewsb.cb.att.com (robert.f.casey)  
Subject: ft890 mod file  
Message-ID: <1993Jan24.005316.5410@cbfsb.cb.att.com>  
Keywords: mods  
Sender: news@cbfsb.cb.att.com  
Organization: AT&T  
Date: Sun, 24 Jan 1993 00:53:16 GMT  
Approved: wa2ise@cbnewsb.cb.att.com  
Lines: 34

copied from packet:

| Msg#           | Size | #Rd  | Date | Time   | From | MsgID             | To          |
|----------------|------|------|------|--------|------|-------------------|-------------|
| 32972          | BF   | 2276 | 0    | 13-Jan | 1142 | F1LOU_30527_ON7RC | YAESU@WW () |
| Sb: FT890 MODS |      |      |      |        |      |                   |             |

YAESU FT890/AT mod. TX 1,5 to 30 MHZ.  
=====

- Disconnect FT890 from all connections.
- Open tranceiver like explained in your "OPERATING MANUAL".
- Locate on the "CONTROL UNIT" jumper point JW 3001 and close it with solder.
- Close tranceiver back and reconnect power.
- Push PROC, AGC-F, IPO, ATT while power ON.
- Now the display shows two digits of numbers and tree of letters (i.e 13 OFF)  
Rotate main knob and set the display to "02 ON". Now press the PROC button.
- Power OFF and then back ON. It's all!
- Now every time you want, you can change the programation, but you will allways lose the memories.
- Other settings than "02 ON" are of no interest. This one give you 100 w and automatic antenna tuning between 1,5 and 30 mhz.

73's de Phil, F1LOU @ ON7RC.BT.BEL.EU  
=====

Note: I haven't tried or verified this, proceed at your own risk, and do not transmit outside of legal bands! WA2ISE



Newsgroups: rec.radio.info  
From: wa2ise@cbnewsb.cb.att.com (robert.f.casey)  
Subject: FT990 mod file  
Message-ID: <1993Jan24.005552.5479@cbfsb.cb.att.com>  
Keywords: mods  
Sender: news@cbfsb.cb.att.com  
Organization: AT&T  
Date: Sun, 24 Jan 1993 00:55:52 GMT  
Approved: wa2ise@cbnewsb.cb.att.com  
Lines: 24

copied from packet:

| C | Msg#           | TSF | Size | #Rd | Date   | Time | From  | MsgID       | To          |
|---|----------------|-----|------|-----|--------|------|-------|-------------|-------------|
|   | 32971          | BF  | 1872 | 0   | 13-Jan | 1143 | F1LOU | 30528_ON7RC | YAESU@WW () |
|   | Sb: FT990 MODS |     |      |     |        |      |       |             |             |

YAESU FT990 - 1.5 to 30 MHZ TX mod:  
-----

-Open FT990 like explained in your OPERATING MANUAL.

-Localise JP5002 on "CONTROL UNIT" and close it with solder.

-If no transmit between 4 to 6.5 MHZ and 8 to 10 MHZ, do the following:

- 1) Display 5.5 MHZ in CW mode, "meter selector" to ALC, push "MOX" button and adjust VR1003 on "RF UNIT" for normal ALC meter deflection.
- 2) Display 9 MHZ and do the same with VR1005.

73's de Phil F1LOU @ ON7RC.BT.BEL.EU  
-----

Note: I havent tried or verified this, proceed at your own risk, and do not transmit outside of legal bands! WA2ISE



From : N3GPP @ N3GPP.#EPA.PA.USA.NA  
To : MOD @ ALLUS  
Date : 920202/1710  
Msgid : BF 6@N3GPP, 5258@W6VIO \$6\_N3GPP  
Subject: YAESU FT-990

GENERAL COVERAGE TRANSMIT MOD FOR MARS OPERATION YAESU FT-990  
REMOVE TOP COVER  
LOCATE AND REMOVE CTRL BOARD (CTRL BD. IS THE FAR RIGHT VERTICLE BD  
LOOKING AT THE TRANCEIVER FROM THE FRONT. REMOVE TWO PHILLIPS HEAD  
SCREW AND LIFT OUT BOARD.)  
LOCATE JP5002 (JP5002 IS LOCATED ON THE FAR RIGHT OF THE PC BOARD  
NEAR THE TOP OF CHIP Q5016. Q5016 IS THE THIRD BIG CHIP LOCATED AT  
THE FAR RIGHT OF THE PC BOARD.)  
SOLDER JUMPER JP5002  
RE-INSTALL BOARD  
SET MODE TO CW  
METER TO ALC  
RF CTRL FULLY CLOCKWISE  
ADJUST VR1003 AT 5.000 Mhz TO FULL ALC METER READING.  
ADJUST VR1005 AT 8.000 Mhz TO FULL ALC METER READING.  
VR1003/1005 ARE LOCATED ON THE FAR LEFT VERTICLE BOARD LOOKING AT  
THE TRANCEIVER FROM THE FRONT. THE POT ARE ADJUSTABLE FROM THE TOP.  
THERE IS NO NEED TO REMOVE THIS BOARD.  
RE-ASSEMBLE THE RADIO AND YOU ARE READY TO GO.

I WOULD LIKE TO HEAR OF ANY OTHER MODS AVAILABLE FOR THE FT-990.  
I'AM SURE THERE IS A LOT OF STUFF THAT CAN BE DONE THROUGH THE  
KEYPAD LIKE ON THE KENWOOD TS-850.

73'S BOB





From: wa2ise@cbnewsb.cb.att.com (robert.f.casey)  
Newsgroups: rec.radio.amateur.misc  
Subject: FT990 and 1000 extended xmit mod file  
Keywords: mod file  
Message-ID: <1992Apr4.145318.5487@cbfsb.cb.att.com>  
Date: 4 Apr 92 14:53:18 GMT  
Sender: news@cbfsb.cb.att.com  
Organization: AT&T  
Lines: 18

copied from packet:

| Msg#                        | TSF | Size | #Rd | Date   | Time | From  | MsgID        | To         |
|-----------------------------|-----|------|-----|--------|------|-------|--------------|------------|
| 7086                        | BF  | 1241 | 0   | 28-Mar | 1106 | F6HKA | 80214_FC1MAC | MODS@WW () |
| Sb: Modification FT990-1000 |     |      |     |        |      |       |              |            |

I received a mail from AA6SQ about Extended transmitter frequency range for FT990 and FT1000

-Remove top and bottom covers. Remove top screw on each side which holds front panel to chassis. Pivot front panel down slowly. CAUTION : if you let it go, it will flop down rapidly and probably tear somethins loose. Behind the meter will be the CNTL unit. It has a metal cover about 4 \* 8 inches. Snap the cover off. Look to the top of the unit. You will see JP-3. Remove the solder connection on JP-3.

Best 73 and good traffic on HF bands . Bert fF6HKA

=====  
Note: I haven't tried or verified this, proceed at your own risk. And do not transmit outside of legal bands! WA2ISE



Article: 32166 of rec.radio.amateur.misc  
From: kchen@Apple.COM (Kok Chen)  
Newsgroups: rec.radio.amateur.misc  
Subject: Re: FT990 mod for extended tx  
Message-ID: <76900@apple.apple.COM>  
Date: 17 Jan 93 23:01:05 GMT  
References: <1jcftdINNh42@tamsun.tamu.edu>  
Organization: Apple Computer Inc., Cupertino, CA  
Lines: 51

blw7149@tamsun.tamu.edu (Brandon Lee White) writes:

>I received a mail from AA6SQ about Extended transmitter frequency range  
>for FT990 and FT1000  
>-Remove top and bottom covers. Remove top screw on each side which holds  
>front panel to chassis. Pivot front panel down slowly. CAUTION : if you  
>let it go, it will flop down rapidly and probably tear somethins loose.  
>Behind the meter will be the CNTL unit. It has a metal cover about 4 \* 8  
>inches. Snap the cover off. Look to the top of the unit. You will see  
>JP-3. Remove the solder connection on JP-3.

This appears similar to the mod given for the FT-1000 that is given  
in "Radio/Tech Modifications, Volume 5B," ISBN 0-917963-011-3,  
published by artsci, inc.

BUT! The mod for the FT-990 that appears in the same book is  
completely different. I tend to believe the book, since the control  
unit for the FT-990 is on a plug-in card to the motherboard, and not  
a thing attached to the front panel.

I did not attempt to make the extended range mod, but I did make a  
mod to my FT-990 (didn't read of this mod anywhere, I simply traced the  
schematics) to reduce the minimum power output from 10W to about 3.5W,  
to operate QRP using the last ARRL 10m contest.

(I just felt like getting 59 reports from everyone that weekend,  
and, except for one truthful gentleman in NC, I did :-).

I didn't blow anything up, but do the following at your own risk.

Find the R.F. power control pot in the schematics. All this pot does  
is to supply a variable voltage level to the ALC circuitry. Trace  
the signal from the pot to the ALC goodies, and you will find a series  
limiting resistor whose value is 1/10 that of the pot's max value.  
This is what limits min power to about 10W. I simply paralleled this  
fixed resistor (a surface mount resistor on the board with the ALC  
sensing circuitry) with a smaller axial resistor.

You have to raise power to 8W or so to get the automatic antenna tuner  
to buzz and click. That may be why the power control knob would not  
go below 10W on a stock unit; would only confuse all the appliance  
operators :-).

BTW, has any other FT-990 owners noticed that the built-in computing  
SWR meter is quite inaccurate at powers below 25W?

73,

Kok Chen, AA6TY  
Apple Computer, Inc.

kchen@apple.com



Newsgroups: rec.radio.amateur.packet  
From: wa2ise@cbnewsb.cb.att.com (robert.f.casey)  
Subject: Ramsey FX 146 mod for packet file  
Message-ID: <1992Apr4.144906.5408@cbfsb.cb.att.com>  
Keywords: mod file  
Sender: news@cbfsb.cb.att.com  
Organization: AT&T  
Date: Sat, 4 Apr 1992 14:49:06 GMT  
Lines: 17

copied from packet:

| Msg# | TSF | Size | #Rd | Date   | Time | From  | MsgID       | To               |
|------|-----|------|-----|--------|------|-------|-------------|------------------|
| 6886 | BF  | 728  | 0   | 29-Mar | 1800 | AA2ES | 1289_WA2AAR | RAMSEY@ALLUSA () |

Sb: FX-146 Packet Mod

Anyone experiencing low audio levels on transmit when in packet mode and using the rear 5-pin DIN connector may find this mod useful. It worked for me.

C65 which connects the AFSK input from the TNC to the mic line has the standard value, .01uf. In my case this caused severe attenuation of the AFSK signal to the point where I was unable to connect to anything. Replacing C65 with a 0.1uf cap cured the problem.

73 - Ian, AA2ES@WA2AAR.NJ.USA.NA

=====  
Note: I haven't tried or verified this, proceed at your own risk. WA2ISE



From: billp@niagara.Tymnet.COM (Bill Putney)  
Newsgroups: rec.radio.amateur.misc  
Subject: G.E. MVP to a Repeater (Instructions)  
Message-ID: <2163@tymix.Tymnet.COM>  
Date: 29 Jul 92 17:29:57 GMT  
Sender: usenet@tymix.Tymnet.COM  
Reply-To: billp@niagara.Tymnet.COM (Bill Putney)  
Distribution: usa  
Organization: BT North America (Tymnet)  
Lines: 226  
Nntp-Posting-Host: niagara  
Originator: billp@niagara

I know nobody asked but I did this for someone else and I thought it would be nice to share the information. A lot of clubs these days have a need for a new repeater and what with the economic thing don't have a lot of money to spend. There is a lot of junk being marketed as ham repeaters (i.e. Spectrum Communications) for horrendous prices. I thought it would be nice for people to have the choice to do the Ham thing and save a bunch of money.

These radios are available all over the place for very modest prices and make great repeaters. They work on our California mountain tops without being fried by the other R.F. around. Better yet they are a good neighbor. They put out power on just one frequency at a time and the receivers are selective enough to work on 12.5 Khz split channels (though most Japanese portable radios wont). The transmitters are very clean if tuned up according to G.E. instructions. Transmitter tuning only requires a wattmeter, dummy load and a VOM. I have tuned the receivers up with just a weak signal on channel but I do recommend a signal generator. The MVP's will put out ~60% of it's rated power (there are several models ranging from 5-35 watts) continuous duty. This isn't a lot of power but at least when you add an power amp to it the amp won't be multiplying garbage.

P.S. No I don't work for a company that sells MVP's nor am I interested in duplexing any more for other people. I really love these little puppies and I have them running all over the place but I've done 20 or so and I'm not as young as I use to be. :)

----- Cut ? -----

Instructions for Duplexing a G.E. MVP  
by Bill Putney  
WB6RFW

These instructions will work for MVP's on any band.

Before you start, test the radio completely to establish a benchmark for post conversion testing. It is better to find any problems that exist in the basic radio and fix them now. After the conversion you only need to find the problems you created.



MVP C.G. encoder/decoders are pretty useless after the radio has been duplexed so now is a good time to get rid of it. Don't forget to replace the resistor between H1 and H2 on the System-Audio-Squelch board (The SAS Board). Most of the duplexing is done on the SAS board.

- 1) Remove the SAS board from the radio.
- 2) Cut the printed circuit land that connects J904 pin 2 to U902 pin 7. The best place I've found to do this is right near U902 pin 7 on the solder side of the board. There is a land that goes from U902 pin 7 to a via pad. This trace is only about 1/8" long and is shown in gray in the MVP manual Outline Diagram. I use an Exacto knife to make these cuts. Make two cuts perpendicular to the run of the land about 1/16" apart then remove the land in between by prying up one end and peeling the copper away. This disconnects the receiver oscillator control line so that the U902 no longer can turn the oscillator off during transmit.
- 3) Place a jumper between J904 pin 1 and pin 2. I do that right at J904 on the solder side of the board. This puts regulated 10V back to the receiver osc. control line so that the oscillator is always enabled.
- 4) The next cut is a little harder to find. The line on the schematic that connects the junction of CR901, U902 pin 6, and J906 pin 5 to the junction of R905, R906 CR905, C906 and U901 pin 7. On the schematic it's a nice straight vertical line just above U902 but on the board it runs all over the place in and out of via's, from the solder side to the component side and back again. The place I cut it is on the component side of the board near J905. Set the SAS board on the bench with the component side up and the board oriented as shown in the MVP Manual Outline Diagram. On the Outline diagram you can see two component side lands that run parallel along the bottom edge of the board the whole length of J905. The bottom most land connects H16 to J906 pin 4. Don't cut this one... The one you want is the next one up. It kind of looks like an S on the board and runs between J906 pin 5 and a via just below U902 (next to H5). I make the cut near the end (pin 7 end) of J905 before it makes a turn and goes up toward U902. Make the cut as described in 2) above.
- 5) All of the I/O lines to the radio can be found on the SAS board and should be connected before you put the board back in the radio.

PTT is at H17. This is a ground to transmit line.

COS is at J912. This line is ~0.1V when the radio is squelched and ~9.0V unsquelched. Don't try to run a relay from this COS line. I'd use a CMOS gate to buffer

it. If you're using a modern controller chances are that it uses COMS logic and the buffer isn't required.

Mike in is at J913. This line has mic bias on it and should be capacitor isolated. It takes about 2V P-P to drive the radio to 4.5 Khz deviation.

Receiver audio is found at H16. This is unprocessed audio. It is not squelch gated and is not de-emphasized. There is ~4V P-P with 4 Khz deviation on an on frequency signal applied to the receiver. This should not be loaded by less than a 10K input.

- 6) Put the SAS board back into the radio.
- 7) Unscrew and unsolder the SO-239 antenna connector and remove it. (If this is a UHF radio I'd throw it away and get an N connector but it's up to you). After the conversion this will be the transmit antenna connector.
- 8) Unsolder and disconnect the coaxial jumper at H2 on the Filter board. Disconnect P1 (this is the antenna relay control and can be cut off and pulled out of the harness or left alone. It won't do much when you're through).
- 9) Remove the filter board from the radio.
- 10) Using solder wick remove as much solder from around the antenna relay can on the component side of the board as possible. Also use solder wick to remove as much solder as possible from the relay pins on the solder side of the board. If you can remove enough solder from around the pins you can break them loose with a small screwdriver or knife when the solder is cold. This will make the relay easier to remove. With a small pair of diagonal cutters grab a corner of the relay can. Using the soldering iron, heat whatever is stuck and remove the relay.
- 11) Now you need to remake the connection between the output filter and the antenna connector. I use a piece of center conductor from a piece of RG-58 to do this in the hopes that the dielectric and the conductor diameter will keep the impedance about right. This jumper should be placed as close as possible to the circuit board in the holes left by pin 4 and pin 7 of the relay.
- 12) Now you need to rig up an antenna connector for the receiver. THE MOST IMPORTANT THING HERE IS TO HAVE A CABLE WITH A CONTINUOUS SHIELD from the receiver

connector on the front end casting to the antenna connector. This means no voids in the shield around the connectors at each end. If there are unshielded parts of this assembly the receiver will hear the transmitter and the resulting desense will be unacceptable. Use a good quality connector like a BCN or TNC (or type N if you can make it fit...). I like all of the connectors to come out the back of the radio. This is real handy from the point of view of working on the radio later and looks real nice but is a pain to do.

If you chose to do this (or put an accessory connector on the back panel of the radio) you need to take all the boards out of the radio and mask off the back of the radio from the rest with newspaper and masking tape to keep drill filings from getting into every nook in the sheet metal and causing problems later.

Mount the connector as close to the edge of the cover opening as you can or it will hit the filter board when you put it back in. Make sure whatever connector and coaxial you use for this will make the turn to miss the filter can. You could mount all this stuff on the front (plastic panel) and save yourself a lot of work but it wouldn't look as nice and it only takes time to do it right.

- 13) If you choose to put an accessory connector on the back panel I suggest you put it near all the other connectors. To make room for this you will need to remove the little sheet metal doodad G.E. decided to put on the back of the radio. Don't forget to mask off the power connector especially around the base where it meets the back panel of the radio. Metal filings like this way of getting into the radio.

The doodad is held by two spot welds. If you look carefully you can see where they are. Drill these down to the point where the drill is just getting into the back panel. Be careful not to screw up the power connector in the process.

I put the accessory connector next to the power connector. I like 9 pin D type connectors. They are widely available and of good quality. The D shape makes them a pain to mount without a punch (the Greenlee punch for this is >\$280.00). Get the connector as close to the edge of the cover cutout as you can. This keeps it up high in the exciter area and out of the way. You are working through two layers of sheet metal so be careful when (if) you tap the mounting holes as the tap tends to bind between the layers. Put the radio all back together now.

- 14) Put the output filter board back in and solder the transmitter antenna connector back to the tab on the filter board.
- 15) Retest the radio to make sure it survived the operation.

That's all it takes to make a \$100-\$200 MVP nearly as good a duplexed radio as a \$1,000-\$2,000 MSTR II base station!



Subject: HB-232 Announcement

There is a need for an interface between the Radio Shack PRO2004/5/6 series scanners and a computer. It looks like we should have a reasonably priced interface kit and software soon. The following file is from Bill Cheek's Hertzian Intercept BBS in San Diego:

COMMTRONICS ENGINEERING  
PO Box 262478  
San Diego, California 92196-2478  
Computer BBS: (619) 578-9247 (6:00pm - 1:00pm, PDT)

July 10,1992

PRE-ANNOUNCEMENT ADVISORY NOTICE

COMING SOON, the neatest and most powerful scanning tool ever created! The HB-232 Scanner/ Computer Interface turns your PRO-2004, PRO-2005 or PRO-2006 scanner into a TOTAL SYSTEM with power that equals or exceeds anything comparable in the most expensive World Class radios to date! So many features and powerful possibilities are available that it is impossible to discuss them all here, but following is a brief presentation enough to convince you that an awesome performance package is about to make an unprecedented debut!

The HB-232 Scanner/Computer Interface connects between a PC/XT/AT/386/486 clone computer (512-k min) and the scanner. A standard serial cable connects the HB-232 to the computer's COM port. The HB-232 can be installed inside the scanner for a tidy package, or it can be installed in a small project box, with a short cable and plug to mate with a receptacle mounted on the scanner. A serial cable connects the computer to the box. This latter method permits use of the HB-232 with more than one scanner! The scanner is not appreciably modified in either method; rather, 20-wires are connected from the HB-232 to various points in the scanner. Absolutely no scanner features or performance are altered or lost! Now here is what the HB-232 can do!

\* Auto-magically download up to 400 frequencies at a time into the memory channels of your choice in the scanner, along with any desired custom settings such as DELAY, MODE and LOCK-OUT. The time required to auto-program the scanner with 400 custom configured channels is less than 9-minutes! (Try to program 400 channels by hand in any time under than an hour or two, and WHAT IF you find a mistake with your channels out of sequence back on Ch-30?)

\* See and control every standard keyboard function from the computer! Your computer monitor displays a facsimile of the scanner's keyboard and the LCD Display area. Whatever shows in the scanner's LCD Display at any given time is simultaneously displayed on the Monitor. Press M on the computer keyboard for MANUAL; or press S for SCAN; or press P for PRGM. All 29 keys of the scanner's keyboard are active on your computer's keyboard! Anything and everything that shows in the scanner's Display also is displayed on your Monitor screen. The scanner is operated straight from the computer keyboard exactly as it is operated from the front panel. In fact, you can operate from either location simultaneously at any time.

\* AutoLog to a text file every event that the scanner sees! For instance, in the AutoLog mode, every time the SQUELCH breaks (a signal comes in) the

computer writes & appends a line to a text file that contains the channel number or SEARCH Bank; frequency; mode (NFM, AM or WFM); DELAY setting, On or Off; SEARCH increment (if applicable); Date; Start Time; and Duration of transmission! This file is "comma-delimited" to make it exceptionally easy to load it into your favorite database manager for further processing & sorting as desired!

\* Anti-Birdie Function, when activated, compares the frequency that the scanner stops on to a "birdie file", and instantly resumes SCANNing or SEARCHing, if that frequency is in the file! Thus, the scanner will never again lock up on "birdies", if you don't want it to. Neither will it AutoLog momentary "birdie" stops! This superb feature is not limited to just "birdies"; you can put any number of other undesired frequencies into the "birdie file", such as for pagers, computer data channels, continuous tones, encrypted signals, and any other frequencies that you don't want the scanner to stop on or to AutoLog. In fact, there are even ways to automate the collection of undesirable signals for adding to the "birdie file". Gone are the days of obnoxious lockups on uninteresting freqs.

\* The HB-232 generates its AutoLog files in the same format that it needs for programming. Therefore, an AutoLogged SEARCH file can be programmed back into memory channels for a powerful SEARCH & STORE feature.

\* The HB-232 comes with a powerful "scripting" or macro feature to allow you to automate virtually any process that you would normally do by hand. The scripting feature can be used to generate a file of what's been programmed into the memory channels; to set a time limit for stops on various frequencies or channels; to lockout every frequency found during a SEARCH session so that duplicate log entries can be avoided; and the possibilities just go on and on!

\* The HB-232 includes four user-definable switches that can be controlled from the keyboard or through a script! These switches are useful for controlling any modifications that you may have added on your own, including extended memory blocks, automatic tape recorder switches; data/tone squelch; and you can even wire one of these switches to control the stock SOUND SQUELCH function, if you want. Another switch can be wired to give access to the scanner's back-panel RESTART function! A little work in the scanner could allow you to use one of these switches for the ATTenuator switch on the scanner's back panel, too! The possibilities are nearly endless!

\* The HB-232 comes with an easy-to-use built-in text editor to help edit your AutoLogged and AutoProgram files and any other text file, for that matter! Features and benefits of the HB-232 Scanner/Computer Interface are simply too numerous to continue with here in this limited space.

Now I have to tell the rest of the story .....the bad side! Really, there isn't a bad side, but if anything at all must be said against the HB-232, it's that it comes ONLY as a Kit of Parts and a Program Disk. You have to build and install the HB-232 yourself or have someone to do it for you, if you can't. The HB-232 Kit includes a professional printed circuit board, one Motorola microprocessor chip and special socket, six other IC's, four resistor networks (similar to an IC), a quartz crystal, one discrete resistor, and fifteen capacitors. NOT supplied are the required serial cable; five common IC sockets (four 14-pin DIP and one 16-pin DIP); wires, plugs, connectors; tools, solder, project box (if an external installation is desired), etc. The functional part of the HB-232 Kit is complete, however. Depending on your

skills and ability, it will take 2-4 hours to assemble the board and 2-6 hours to install it. Add to this another 1-4 hours for preparation. Assembly of the board is straightforward and requires only basic soldering skills and the ability to match component locations with a parts location diagram; easy enough. Installation, whether in a project box or internal to the scanner, is a bit more technical, though well within the capability of the electronic hobbyist. The finished HB-232 board measures 3-1/8"L x 2-5/8"W and the thickness of the board, counting all parts mounted thereon is about 1/2".

The PRO-2004 is the easiest scanner in which to do the installation, because all wiring points are readily accessible and identifiable. The PRO-2005 & PRO-2006 are easier than the PRO-2004 in twelve of the wiring points, but five wires have to be tack-soldered on the BACK SIDE of the Logic/CPU Board that's mounted inside the front panel of the scanner. This is a straight-forward job, but might intimidate the scannist who has never removed that board before.

Still, the directions are methodical and clear enough and the main requirement is only PATIENCE and the ability to locate five solder pads on the board from a picture that's provided. Frankly, the hardest overall part of the job is the fabrication and wiring of the PCB. So it's mostly time consuming, but if you are patient and can handle a soldering pencil and do a little mechanical work, then this project is not beyond your scope.

Since there is practically nothing in the scanner to modify (other than solder wires to specific points), it is unlikely that serious harm will be done to the scanner, even if you err. I and others who have tested the HB-232 have all made errors of one sort or another in the development of the HB-232 and not yet has any irreparable harm come to either the HB-232 or the scanners!

So what now? The HB-232 is not available for sale yet, but it is in the final stages of "Beta Testing". Pre-announcement will be available upon conclusion of the Beta Test, starting in late July or early August. Discount prices will also be available until the formal announcement probably in September or October. The discounted "Charlie Test" price, will be \$129.95 + \$5 S&H.

I suspect there will be limited quantities of the HB-232 for a while because of the expensive and hard to get microprocessor chip, but I will be happy to accept advance reservations for the HB-232 on the condition that you make a deposit of \$25 and be willing to wait for delivery through at least the end of August. A refund of your deposit will be available for the asking any time before shipment is made. You can also reserve an HB-232 Kit without a deposit, but it's first come, first served to those who make a deposit and then to those who are on the no-deposit reserved list. If you are not able or willing to build and install the HB-232 Kit, I can be available to do it for you. The cost to build the board only (you install it) will be \$50 plus the cost of the Kit. Installation inside the scanner, including building the board will be \$150 plus the cost of the Kit. Construction and installation of the HB-232 in an external project box and the necessary wiring of one scanner will be \$225 plus the cost of the Kit. Additional scanners can be wired to accept an external HB-232 for a cost of \$50 per extra scanner. Return shipping for all scanner installations will be \$12.00, and shipping of Kits or fabricated circuit boards only will be \$5.00.



You might be interested to know that while the first HB-232 units will be available only for the Realistic PRO-2004, PRO-2005 and PRO-2006 scanners, there is a good chance that the developer can adapt the HB-232 to the Uniden BC-760/950XLT, BC-590/600XLT and the Regency R-1600. For the latest on this and other developments of the HB-232, contact us by US Mail or at our Computer BBS, the Hertzian Intercept, between 6:00pm-1:00pm, PDT, at (619) 578-9247.

Bill



Article: 18757 of rec.radio.shortwave  
Path: news.cs.tut.fi!butler.cc.tut.fi!fuug!mcsun!uunet!caen!destroyer!  
cs.ubc.ca!unixg.ubc.ca!unixg.ubc.ca!fargher  
From: fargher@unixg.ubc.ca (Robert Fargher)  
Newsgroups: rec.radio.shortwave  
Subject: HF-250 Update  
Date: 7 Mar 93 02:26:04 GMT  
Organization: The University of British Columbia  
Lines: 64  
Message-ID: <fargher.731471164@unixg.ubc.ca>  
NNTP-Posting-Host: unixg.ubc.ca  
Keywords: Lowe HF-250

The following is the text of a faxed press release from the Lowe people.

At a time when we were enjoying great success with our HF-225 receiver, John Thorpe and I began to plan a long way ahead for its eventual replacement, and the model name we chose for that replacement was the HF-250. As time passed, we began to see another market opportunity for a lower cost receiver which we could introduce in addition to the HF-225 and so switched development effort into what became the HF-150. This of course left the HF-250 project on one side, and the further success of the HF-150 together with the seemingly never-ending appreciation of the HF-225 in the market kept us all very busy trying to produce enough receivers to satisfy the demand.

Now that we have the HF-150 and HF-225 well established, we have decided that the HF-250 project should be changed from being a replacement for the HF-225 to a totally different market area, and we therefore scrapped all the original work and began again on the HF-250 with the intention of attacking the market for receivers like the JRC NRD-535 and the Drake R-8. From what I have seen and heard so far, this new receiver will be both impressive and totally innovative, but of course the fact that we began again will mean that there will be a delay before you will see it.

So - those of you who are waiting for the HF-250 as a replacement for the HF-225 will be disappointed. We have no plans to finish the HF-225; in fact in its limited edition version, the "Europa", the HF-225 continues to win admirers (and awards) all over the world. Why should we kill a winner??

Finally, John Thorpe prefers to refer to his new receiver as "Development Project N", so from now on the HF-250 will die, and Project-N will take its place until such time as we allocate its final model number. Keep watching - we are going to surprise a lot of people.

#### Current Production Range

HF-150 Dubbed the "portatop" by Larry Magne of "Passport to World Band Radio", and has more glowing reviews than any other receiver in its field.

HF-225 Awarded "Receiver of the year" by "World Radio and TV Handbook" in 1990. Plain and simple in appearance, a joy to use; and performance better than the new FRG-100.

HF-225 A customized version of the HF-225 for the really dedicated DX Europa enthusiast. Awarded "Best DX Receiver" at the EDXC Conference in

Tampere, Finland in 1992, beating the NRD-535 and ICOM R-72E.

HF-235 Professional version of the HF-225 in rack mount form and with High stability and remote control options. Now in service with Government and major airline companies who want solid performance and uncompromising reliability - at an affordable price.

Project N Top of the range, and intended to beat all competition at the top of N market. (But you will have to wait.)

---

Hearsay has it that they hope to have a demo version of Project N on display in the August CES.

Cheers,  
Rob

--

Robert Fargher fargher@unixg.ubc.ca | The number of things that I know  
Dept. of Physiology, UBC | absolutely nothing about is increasing  
Vancouver, BC, Canada, V6T 1Z3 | at an alarming rate!



From: CRAIG/N7ETV @ WB6MQM  
Subject: UNIDEN QSK MODIFICATION

I just received this note on packet. It might be of interest to those who own Uniden 10-meter transceivers and wish to use them on packet and/or AMTOR:

Msg# TSP Size To @ BBS From Date Time Bid  
15362 PY 1569 KD2BD N7ETV 901130 1711  
>Subject: UNIDEN QSK MODIFICATION

Thanks!!! to Craig, N7ETV for the following info...I will copy this to all of you who responded to my message.  
Mike/KA3NVP

HELLO:

AFTER HOOKING UP MY HR-2600 TO MY PK-232, I FOUND I HAD SOME PROBLEMS USING IT IN AMTOR. SINCE I LOVE TO MODIFY AND "FIX" RIGS, I GRABBED MY TEST EQUIPMENT AND SET OUT TO FIND OUT WHY THERE WAS A LONG SWITCH-OVER DELAY TIME. AFTER A FEW MINUTES, I FOUND OUT THAT THE RECIEVER WAS COMM-ING UP OK. IT WAS THE MUTE CIRCUIT THAT WAS SLOW. I FOUND TWO CAPACITORS THAT WERE RESPONSIBLE FOR THE DELAY IN THE MUTE CIRCUIT. TO FIX THE PROBLEM, CHANGE OUT C74 AND C99 (BOTH ARE 4.7uf @ 50VDC) WITH .01uf DISC CAPACITORS WITH A VOLTAGE RATING GREATER THAN 15VDC. THESE CAPACITORS ARE ALSO FOUND IN THE HR-2510 AS WELL. THESE SEEM TO BE C139 AND C99 IN THE HR-2510 IF MY COPY IS RIGHT. THESE CAPACITORS ARE LOCATED NEXT TO THE AUDIO OUTPUT IC (TDA1905) IN THE RADIO. THIS I.C. IS LISTED AS IC2 IN THE HR-2600 AND IC103 IN THE HR-2510. I ALSO FOUND THE S/RF METER TO BE VERY SLOW IN MY RIG. I FIXED THIS BY CHANGING C302 ON THE CONTROL UNIT (LOCATED NEXT TO J304) TO A .01uf DISC CAPACITOR ALSO. THIS CAPACITOR IS ALSO IN THE HR-2510. AFTER THESE MODIFICATIONS, I HAD NO MORE PROBLEMS MAKING ANY CONNECTS IN ANY MODE. 73'S AND ENJOY THE UNIDEN!

CRAIG/N7ETV @ WB6MQM  
LAS VEGAS, NEVADA. 89121

NN2Z>

73, de John, KD2BD

--

John A. Magliacane  
Electronics Technology Department  
Brookdale Community College  
Lincroft, NJ 07738 USA

FAX : (908) 747-7107  
AMPR : KD2BD @ NN2Z.NJ.USA.NA  
UUCP : ...!rutgers!ka2qhd!kd2bd  
VOICE: (908) 842-1900 ext 607



Subject: R/S HTX-100 Modifications

copied from packet:

| Msg#  | TSF | Size | #Rd | Date   | Time | From   | MsgID       | To             |
|-------|-----|------|-----|--------|------|--------|-------------|----------------|
| 19802 | BF  | 2860 | 3   | 15-Mar | 2108 | KB2JPD | 13416_K2KJC | MODS@ALLBBS () |

Sb: \* Tandy HTX-100 Mods

---

The Modification Files for the Tandy HF HTX-100 USB/CW Transceiver

---

Topics Covered

---

- \*Extended Frequency Coverage from 26.000 Mhz to 30.000 Mhz
- \*Simple RF Wattage Enhancement to 35 Watts
- \*Enhancement of Microphone Frequency Response

---

Fair Warning and Friendly Advice To Very Anxious and Excited People

---

We are not responsible for any damage on your part. If you don't know don't do it. Let someone with more experience do it.

---

Thank you for your interest. The Tandy HTX-100 Amateur Radio Transceiver is a close cousin of the Uniden HR-2510 (Listed as the Amateur Radio Mode HR- 2510 (UT-550B). HTX for Ham Transceiver, HR for Ham Radio, UT for Uniden Transceiver. We can assume the A suffix for the HTX-100.)

My first HF radio as a Novice was a HTX-100, so there was always a lingering question as if the Tandy model was capable of similar capabilities. I had spent many hours examining the mini-schematic diagram at the end of the manual.

This information was derived from the buying of a HR-2510 service manual at the local hamfest. When I examined the PLL schematic, I realized that I was looking at a prior generation of the same PLL circuit. It helped to complete the purchase.

The Uniden HR-2510 microcontroller u1201 is a 46 pin Dual Inline Package. On the diagnostic voltage table for the microcontroller, there are two pins labeled (34)AMATEUR and (35)GND aside of each other. They are pulled to GROUND.

#34 will open TX/RX from 26.000 Mhz to 28.000 Mhz, #35 will open 29.7 to 30 Mhz.

On the schematic for the HTX-100, there are similar pins 28 and 29 on U1208 pulled up by a resistor pack to Vcc.

The Tandy model microcontroller is a surface-mount device and the pins on the chips don't bend: they SNAP. The steel used on the pins are quite different. Do not attempt to physically pull on the pins of the package.



Percy KF2AT wrote the mods for the HTX-100.  
Use common sense, a grounded soldering iron, and enjoy the mods.

Adam Kb2Jpd

\*Extended Frequency Coverage from 26.000 Mhz to 30.000 Mhz

---

Thanks Percy for being the first one.

Remove bottom cover. With the radio upside down and display facing you remove the synthesizer board with the four screws, this is near the front of the radio.

This gives access to the small board underneath with the surface mount components on it. Locate the processor chip IC401 (UC-1208). Locate pins 28 and 29 which are on the right hand side of the chip and are 4th and 5th from the top. Note they are bridged with solder.

CAREFULLY cut the copper track NEXT to the pins. DO NOT attempt to unsolder the two pins from the board. Use a GROUNDED soldering iron. Locate the two rows of connector pins above the chip.

On the bottom row locate the last pin on the right. Verify with a VOM that this pin has + five volts. Solder a 10k (1/4 w) resistor between this pin and pins 28 and 29 on IC401. The synthesizer will now tune from 26.00 Mhz to 30 Mhz.

---

\*Simple RF Wattage Enhancement to 35 Watts

With the radio in the same position as before, locate VR5 in the top left hand corner. This is the RF high power preset.

Lift and bend the wiper so that it is permanently disconnected from the track. Solder a 47k resistor (1/4 watt) between the wiper and the left hand side of the track.

This should increase the RF power output to around 35 watts but you will now not be able to trim the power output. The Low power trim will function as before.

---

Enhancement of Microphone Frequency Response

1) To increase average depth of modulation

-- -- -----  
Remove top cover of the radio and with the display facing you and the radio upright locate IC3 (MJM45585) near the bottom right hand corner of the main large board.

Just to the right of this IC locate c75 (56 pf) and remove it. This will increase the gain of the microphone Preamp considerably but without

overmodulation. If you find the compression excessive (i.e. background noise) open the microphone and insert a 470 ohm resistor between the hot side of the mic insert and the input (white lead).

This will reduce the gain somewhat but will still give you much increased "talk power" (percy's words, not mine. Adam).

2) To increase audio response in the high mids

-----  
This simple mod will recrease the audio response in TX in the 2 to 2.7 khz region giving higher articulation and move intelligibility under weak signal conditions.

Locate IC3 as before on the large main board and the radio positioned as before.

Locate a 5.6k and a 4.7k resistor just below IC3. Solder a 0.015 mf (16v) capacitor between the left side of the 4.7k to the right side of the 5.6k resistor.

These two mods work together to give improved readability on SSB under DX conditions.

-----

Percy, KF2AT, for taking the chance on his own radio, and wildly succeeding. Jeff, N2LJA, for selling the radio to Percy and writing it off as a loss. Tony, Kb2JYN, for being the test rabbit. MAY the rabbit rest in peace. 73 de Percy KF2AT and Adam Kb2Jpd @K2KJC.NY or @Kb2itr.NY.

(C) Copyright Adam Vazquez and Percy Jones. This documentation is for informational use. This information may be not published in modification manuals printed with the purpose of generating revenue without the prior consent of the authors. This information is released from hams to hams. It is free.

The authors are not responsible for any damages on your part. Don't do this unless you have: prior electronics background & knowledge of cutting up SMT circuitry.

=====  
Note: I haven't tried or verified this, proceed at your own risk. And do not transmit outside of legal bands! WA2ISE

-----  
The phone company knows your phone number! :-)



Newsgroups: rec.radio.amateur.misc  
From: wa2ise@cbnewsb.cb.att.com (robert.f.casey)  
Subject: Radio Shark HTX101 mod file  
Message-ID: <1992Mar21.222927.15366@cbfsb.cb.att.com>  
Keywords: mods  
Sender: news@cbfsb.cb.att.com  
Organization: AT&T  
Date: Sat, 21 Mar 1992 22:29:27 GMT  
Lines: 147

copied from packet:

| Msg#                     | TSF | Size | #Rd | Date   | Time | From   | MsgID       | To             |
|--------------------------|-----|------|-----|--------|------|--------|-------------|----------------|
| 19802                    | BF  | 2860 | 3   | 15-Mar | 2108 | KB2JPD | 13416_K2KJC | MODS@ALLBBS () |
| Sb: * Tandy HTX-100 Mods |     |      |     |        |      |        |             |                |

---

The Modification Files for the Tandy HF HTX-100 USB/CW Transceiver

---

Topics Covered

---

- \*Extended Frequency Coverage from 26.000 Mhz to 30.000 Mhz
- \*Simple RF Wattage Enhancement to 35 Watts
- \*Enhancement of Microphone Frequency Response

---

Fair Warning and Friendly Advice To Very Anxious and Excited People

We are not responsible for any damage on your part. If you don't know don't do it. Let someone with more experience do it.

---

Thank you for your interest. The Tandy HTX-100 Amateur Radio Transceiver is a close cousin of the Uniden HR-2510 (Listed as the Amateur Radio Mode HR- 2510 (UT-550B). HTX for Ham Transceiver, HR for Ham Radio, UT for Uniden Transceiver. We can assume the A suffix for the HTX-100.)

My first HF radio as a Novice was a HTX-100, so there was always a lingering question as if the Tandy model was capable of similar capabilities. I had spent many hours examining the mini-schematic diagram at the end of the manual.

This information was derived from the buying of a HR-2510 service manual at the local hamfest. When I examined the PLL schematic, I realized that I was looking at a prior generation of the same PLL circuit. It helped to complete the purchase.

The Uniden HR-2510 microcontroller u1201 is a 46 pin Dual Inline Package. On the diagnostic voltage table for the microcontroller, there are two pins labeled (34)AMATEUR and (35)GND aside of each other. They are pulled to GROUND.

#34 will open TX/RX from 26.000 Mhz to 28.000 Mhz, #35 will open 29.7 to 30 Mhz.

On the schematic for the HTX-100, there are similar pins 28 and 29 on U1208 pulled up by a resistor pack to Vcc.

The Tandy model microcontroller is a surface-mount device and the pins on the chips don't bend: they SNAP. The steel used on the pins are quite different. Do not attempt to physically pull on the pins of the package.

Percy KF2AT wrote the mods for the HTX-100.  
Use common sense, a grounded soldering iron, and enjoy the mods.

Adam Kb2Jpd

\*Extended Frequency Coverage from 26.000 Mhz to 30.000 Mhz

---

Thanks Percy for being the first one.

Remove bottom cover. With the radio upside down and display facing you remove the synthesizer board with the four screws, this is near the front of the radio.

This gives access to the small board underneath with the surface mount components on it. Locate the processor chip IC401 (UC-1208). Locate pins 28 and 29 which are on the right hand side of the chip and are 4th and 5th from the top. Note they are bridged with solder.

CAREFULLY cut the copper track NEXT to the pins. DO NOT attempt to unsolder the two pins from the board. Use a GROUNDED soldering iron. Locate the two rows of connector pins above the chip.

On the bottom row locate the last pin on the right. Verify with a VOM that this pin has + five volts. Solder a 10k (1/4 w) resistor between this pin and pins 28 and 29 on IC401. The synthesizer will now tune from 26.00 Mhz to 30 Mhz.

-----  
-

\*Simple RF Wattage Enhancement to 35 Watts

With the radio in the same position as before, locate VR5 in the top left hand corner. This is the RF high power preset.

Lift and bend the wiper so that it is permanently disconnected from the track. Solder a 47k resistor (1/4 watt) between the wiper and the left hand side of the track.

This should increase the RF power output to around 35 watts but you will now not be able to trim the power output. The Low power trim will function as before.

-----

Enhancement of Microphone Frequency Response

1) To increase average depth of modulation

Remove top cover of the radio and with the display facing you and the radio upright locate IC3 (MJM45585) near the bottom right hand corner of the main large board.

Just to the right of this IC locate c75 (56 pf) and remove it. This will increase the gain of the microphone Preamp considerably but without overmodulation. If you find the compression excessive (i.e. background noise) open the microphone and insert a 470 ohm resistor between the hot side of the mic insert and the input (white lead).

This will reduce the gain somewhat but will still give you much increased "talk power" (percy's words, not mine. Adam).

2) To increase audio response in the high mids

This simple mod will recrease the audio response in TX in the 2 to 2.7 khz region giving higher articulation and move intelligibility under weak signal conditions.

Locate IC3 as before on the large main board and the radio positioned as before.

Locate a 5.6k and a 4.7k resistor just below IC3. Solder a 0.015 mf (16v) capacitor between the left side of the 4.7k to the right side of the 5.6k resistor.

These two mods work together to give improved readability on SSB under DX conditions.

Percy, KF2AT, for taking the chance on his own radio, and wildly succeeding. Jeff, N2LJA, for selling the radio to Percy and writing it off as a loss. Tony, Kb2JYN, for being the test rabbit. May the rabbit rest in peace. 73 de Percy KF2AT and Adam Kb2Jpd @K2KJC.NY or @Kb2itr.NY.

(C) Copyright Adam Vazquez and Percy Jones. This documentation is for informational use. This information may be not published in modification manuals printed with the purpose of generating revenue without the prior consent of the authors. This information is released from hams to hams. It is free.

The authors are not responsible for any damages on your part. Don't do this unless you have: prior electronics background & knowledge of cutting up SMT circuitry.

Note: I haven't tried or verified this, proceed at your own risk. And do not transmit outside of legal bands! WA2ISE

The phone company knows your phone number! :-)



From: wa2ise@cbnewsb.cb.att.com (robert.f.casey)  
Newsgroups: rec.radio.amateur.misc  
Subject: HW-24 extended RX mod file  
Keywords: mod file  
Message-ID: <1991Aug24.032353.18156@cbfsb.att.com>  
Date: 24 Aug 91 03:23:53 GMT  
Sender: news@cbfsb.att.com  
Organization: AT&T Bell Laboratories  
Lines: 21

copied from packet:

| Msg#                  | TSF | Size | #Rd | Date   | Time | From   | MsgID       | To             |
|-----------------------|-----|------|-----|--------|------|--------|-------------|----------------|
| 60612                 | BF  | 862  | 0   | 21-Aug | 0530 | KB2JPD | 40864_N2IMC | MODS@ALLBBS () |
| Sb: HW-24 Extended Rx |     |      |     |        |      |        |             |                |

To widen the receiving range of the HW-24-HT:

1. Turn POWER on.
2. Push RESET switch.
3. Press FUNCTION(hold) and STEP, rotate CH to 12.50 kHz.
4. Press CLEAR(#).
5. Rotate CH to 146.0375 MHZ.
6. Press FUNCTION(hold) and RPT.
7. Press FUNCTION(hold) and +.
8. Press FUNCTION(hold) and ENTER. Release buttons.
9. Press FUNCTION(hold) and ENTER.
10. Press CLEAR(#).

---

note: I haven't tried or verified this, proceed at your own risk. WA2ISE





Subject: BAND EXPANSION MODIFICATION FOR IC-02AT  
FOR SERIAL NUMBERS ABOVE 34000  
BY LTC STEVE PETERS, CAP

---

1. Remove back from radio (5 screws) and bottom plate (4 screws).
2. Carefully remove radio chassis from front case by pulling out top of radio and lifting slightly (to remove battery contacts from bottom case). Be extremely careful of ribbon cable and heat sink compound on power amplifier module.
3. Remove diode D2 from matrix board.
4. Add diode D4 (any small diode 1N4148; 1SS211
5. The following is a schematic of the matrix board:

| ADD D4 |       | REMOVE D2 |  |    |   |
|--------|-------|-----------|--|----|---|
| I--+   | --++  | ---+--    |  |    | + |
| V D4   | ID3 I | ID2 I     |  | D1 |   |
| I      | I I   | I I       |  |    |   |
| + +    | +---+ | +---+     |  | +  | + |

6. Install radio chassis back into front cover. Leave back off temporarily.
7. Carefully apply power to radio and enter the lowest desired frequency.
8. Adjust slug through bottom hole on VCO corr for .5 VDC at VCO test point (just below VCO shield) at lowest desired operating frequency.
9. This completes the modification. A few words of caution: 1. The radio is not type accepted for use in the commercial band. 2. Make sure you reinstall the battery latch correctly on bottom of radio or battery will become permanently locked onto radio. 3. Tighten screws on bottom of radio snugly. If they loosen while battery is connected you cannot remove the battery. (This has happened to any units and it would be prudent to periodically check these screws to assure their tightness.)

---

\*\*\*->Be careful not to transmit out-of-band, or accidentally operate on any non-amateur, unless you are authorized to do so.

DO NOT JEOPARDIZE YOUR LICENSE!

[EOF]



Subject: Another Icom IC02 Modification

---

---

The following method of modifying the Icom IC02 is an alternate to the IC02.MOD file. This one should give you PL out of band without jumpering 5 VDC to the tone chip. Use 1N914 or equivalent when adding diodes.

1. On the logic matrix, remove D402 and D403.
2. Add D402, D403 and D404 with the cathode at 4 o'clock and the anode at 12 o'clock.
3. Retune the VCO to cover your desired frequency spread. My 02AT did not want to go beyond 163 MHz. I have a friend who was able to get his to the low 170s.
4. To jump from 140 to 150 or from 150 to 160 (or vice versa) you must "tune across" the boundary, in the same way that you do for an unmodified 02AT. For example, key in 149.995 and then move up until you are in the 150s. You can then enter any 150 MHz frequency (starting with the MHz).

-----  
\*\*\*->Be careful not to transmit out-of-band, or accidentally operate on any non-amateur, unless you are authorized to do so.

DO NOT JEOPARDIZE YOUR LICENSE!

[EOF]



Subject: AUDIO MODIFICATION FOR ICOM IC02 AND IC04 RADIOS =====

---

This audio mod works on the 02 and 04AT. It increases the level of audio, as well as rolling off some of the lows. Sounds real nice. It involves the circuit around Q105.

1. Replace C119 with a .01 uF cap (disc ceramic is fine).
2. Parallel R131 with a 1 uF cap (use a tantalum cap).
3. Parallel R132 with a .01 uF cap (disc ceramic is fine).

This is not the same mod as the one International Radio is advertising, which involves changing C117.

I tried an AB-1 Audiolaster from Engineering Consulting, and was very unhappy with the results. I am very pleased with the audio given by this mod (much cheaper too!).

---

[EOF]



Date: Wednesday, 5 June 1985  
From: Russ Schroeder  
Subject: IC-02A mod  
Re: Modified PLL rigs

The modification to the IC-02A to increase the receiver is fairly straight forward although a little delicate. The programming diodes are located on the board directly behind the front panel, and are located in the corner of the board. They are little rectangular black three leaded devices.

The procedure to modify the radio is as follows:

1) Remove diode D2 - use a very small iron and solder wick to remove most of the solder, then lift the diode GENTLY while heating the single tab side. After getting the first tab free, proceed to the other two tabs, lifting them one at a time. Do NOT use a large iron or too much heat.

2) Take the diode and locate in the position labeled D5. Carefully solder the diode in place.

3) Reassemble the radio except for the back.

4) Program the radio to the local weather channel (162.400 or 162.550) in the following manner: 6 2 4 0 0 or 6 2 5 5 0

NOTE: the programming procedure now requires that you enter the ten's of Mhz when entering a frequency.

5) Look at the back of the radio. In approximately the center of the exposed board is a metal can with two adjustments. The top adjustment is a metal screw (actually a trimmer capacitor) while the bottom adjustment is a black slug with a small rectangular adjusting slot

6) With the squelch open, adjust the lower black core counterclockwise approximately 1 1/4 turns until you receive the weather station. As soon as you receive the weather, STOP turning the adjustment.

7) Replace the back on the radio and you are in business.

With this modification, the radio will tune from 140.000 Mhz to something over 162.550 without difficulty. Just remember that you must enter the ten's of Mhz when entering a frequency. This modification does not affect the transmitter which still covers 140.000 to 151.995 Mhz.

Please note: This mod does not retune any of the RF stages of the receiver so the sensitivity is down some at the weather frequency, however, I have no difficulty receiving it at thirty to forty miles.

I do have the ICOM service manual on the IC-02A. I purchased it from Delaware Amateur Supply at a local hamfest several weeks ago. According to the manual, the VCO on the PLL should cover 25 Mhz. minimum.

Good luck. If you hear of any other mods to the IC-02A please let me



know.

Russ W2DYY

Schroeder.HENR@Xerox.ARPA



Subject: OUT OF BAND MODIFICATION FOR ICOM IC-04

---

1. On the logic matrix, remove D402.
2. Add D402, D403 and D404 with the cathode at 4 o'clock and the anode at 12 o'clock. (You may use any signal diode such as 1N914)
3. Add D405 with the cathode at 8 o'clock and the anode at 12 o'clock.
4. If you have a newer 04AT, the VCO cover will have holes in it that allow access to the tuning coils. If you have an older 04AT you will have to cut a hole in the VCO cover using a pair of small diagonals (be careful!).
5. Retune the VCO to cover your desired frequency spread. My 04AT goes from 441 to 473 MHz, which is pretty good.
6. Any frequency may be entered directly on the keypad (starting with the 10 MHz digit).

-----  
\*\*\*->Be careful not to transmit out-of-band, or accidentally operate on any non-amateur, unless you are authorized to do so.

DO NOT JEOPARDIZE YOUR LICENSE!

===== AUDIO MODIFICATION FOR ICOM IC02 AND IC04 RADIOS =====

---

This audio mod works on the 02 and 04AT. It increases the level of audio, as well as rolling off some of the lows. Sounds real nice. It involves the circuit around Q105.

1. Replace C119 with a .01 uF cap (disc ceramic is fine).
2. Parallel R131 with a 1 uF cap (use a tantalum cap).
3. Parallel R132 with a .01 uF cap (disc ceramic is fine).

This is not the same mod as the one International Radio is advertising, which involves changing C117.

I tried an AB-1 Audiolaster from Engineering Consulting, and was very unhappy with the results. I am very pleased with the audio given by this mod (much cheaper too!).

[EOF]



From: ker@cbnewsj.cb.att.com (kenneth.roser)  
Newsgroups: rec.radio.amateur.misc  
Subject: ICOM IC-2410 mods  
Message-ID: <1991Oct7.031023.4559@cbnewsj.cb.att.com>  
Date: 7 Oct 91 03:10:23 GMT  
Organization: AT&T Bell Laboratories  
Lines: 97

In addition to a previous posting concerning changing the display I thought I would share info on:

- 1.) Extending the receive range
- 2.) Adding an 800 Mhz antenna input
- 3.) Cross-band repeat instructions (local and via remote control)

#### EXPANSION OF RECEIVE RANGE

The following diodes are located on the Logic Unit circuit board. The Logic Unit circuit board sits behind the front panel of the radio. To get to the board remove the top and bottom of the case. Now notice that the front section of the radio is a separate unit from the main body of the radio. Remove the 4 screws holding the sections together but do not yet separate the sections. Place the radio on a table so that it is right side up. Carefully start to separate the sections being careful of ribbon cables that connect the front section of the radio to the rear. If you look at the back of the circuit board on the front section towards the lower part of the radio, you will clearly see three glass diodes labeled D8, D9 and D10. You will know this is the right circuit board because a lithium battery will be taped to it. These are the diodes to cut to get extended receive range as follows:

|     |                  |                                             |
|-----|------------------|---------------------------------------------|
| D8  | 320-399, 830-950 | 800 Mhz coverage requires new antenna input |
| D9  | 118-135          |                                             |
| D10 | 400-479          |                                             |

#### 800 MHZ ANTENNA INPUT

To receive 800 Mhz you need to add a new antenna input to connector J2 on the MAIN-B unit (UHF unit) which is the large circuit board on the bottom of the radio. J2 connects to a the B-band board which is a very small daughterboard, that is connected to the MAIN-B board. The service manual offers no description of this board but it apparently is the 800 Mhz front end.

Two parts are needed:

One 5 3/4" grey coax jumper (this is available from ICOM but it doesn't have a part number)

Either:

One OPC223 pigtail with UHF connector  
or  
One OPC166 pigtail with N connector

The grey coax jumper has a plug on one end that mates with J2 and bare leads on the other. The pigtail also has two bare leads on one end. This same end also has a metal flange thats designed to screw onto the

back panel of the radio after removing one of the dummy caps on either side of the existing antenna pigtail.

Without going into too much detail, you must:

Remove the small metal cap nearest the bottom of the radio and next to the existing pigtail.

Remove the metal shield at the back section of the Main-B unit.

Solder the two pieces of coax together, shield to shield, center to center and screw this assembly on to the back panel.

Plug the grey cable into J2 and then reassemble the radio.

CROSS-BAND REPEAT (An edited version from an ICOM info sheet)

- 1.) Set frequencies for both UHF and VHF. If necessary, set transmit offset and tone.
- 2.) Hold the "BAND" switch and the "SET" switch. The memory number display will flash the letter "L". This indicates the 2410 is in the "Mini Repeater" mode.
- 3.) Transmission by PTT is possible. If PTT is operated, the band which is indicated by the flashing decimal point will be transmitted on. This can be done even when in "Mini Repeat" mode. In other words, PTT has priority over the "Mini Repeat" operation.

Transmitted band will be switched by the "UP" or "DN" key on the microphone. The flashing decimal point will indicate which band will be transmitted on.

- 4.) Mini Repeater function will remain even when power is turned off. To disable repeater function, hold the "SET" key until the flashing "L" disappears.

#### REMOTE CROSS-BAND ACTIVATION

To activate cross-band repeat remotely: after dialing "B", optional 3 digit code then "#", the command for cross-band repeat on is "B", "D", "\*".

To turn off repeat, dial "B", optional 3 digit code, then "#".

DISCLAIMER: Proceed at your own risk. I assume no responsibility if any info posted here causes your radio harm.

--

--

Ken Roser - WA2VCI - ker@mtgzfs3.att.com - AT&T Bell Laboratories - 908-957-5822

--

-----  
Call MR VFO CLR  
1 2 3 A

VHF UHF High Acs  
4 5 6 B

Vmoni Umoni Low Spch  
7 8 9 C

Dwn Mute Up Ent

Please enter a blank line to continue, anything else to halt output

\* 0 # D

#### Other Functions

-----

B# or B???# = External On (?=password) Further protection used Tone/Squelch  
B\* = External Off

DB\* = CrossBand On  
DB# = CrossBand Off

DC = Speech Transmit Freq.

#### Notes

-----

- 4,5,7,8,0 Function not available via External Remote Control????
- C Function not available when in CrossBand Mode????
- Display debate, don't know why the original display was boycotted, but I seen both & had a choice. I preferred the original, lovingly refer to, as stealth. Think twice, before you get the other one.????
- There are diodes to be installed for some features, like transmit in  
Please enter a blank line to continue, anything else to halt output  
rest of UHF ham band (420-450) and extended receive..etc. Check your  
local authorities, regarding scanning laws.

#### Extended Coverage

-----

RX VHF Band:118-174 Mhz.  
TX VHF Band:136-174 Mhz.

RX UHF Band:400-479 + 830 - 950 Mhz.  
TX UHF Band:400-479 Mhz.

#### Tuning Steps

-----

VHF Band: 118-174 Mhz. 5 Khz. 10 Khz. 12.5 Khz. 15 Khz. 20 Khz. 25 Khz.  
UHF Band: 400-479 Mhz. 5 Khz. 10 Khz. 12.5 Khz. 15 Khz. 20 Khz. 25 Khz.  
Cellular: 830-950 Mhz. 10 Khz. 12.5 Khz. 20 Khz. 25 Khz. 30 Khz.

-----  
Do you have any other codes, that I am not aware, please send me a message  
and the info to:

73's de Alex Seiko @:VE3MDY.#CON.ON.CAN.NA North Bay [44.135.108.1]





r 2381r 2381

Date: 28 Apr 90 00:04

Message-ID: <5490@N5WX>

From: N5WX@N5WX

To: MODS@ALLONT

Subject: IC24AT New Info

Path: NT8V!VE3WZL!VE3JEZ!KI4BT!WB9TYT!KC9BK!WA9KEC!N9BYS!N9GTM!AF9M!  
WA9UXP!NQ9Q!KD9LP!KD9QB!WJ9U!KK9G!WD4PPF!K4BFT!WB4GHL!N5WX

There is a later version of IC24AT that does not require  
D13 as in a previous bulletin.

All programming of extended frequency coverage is available  
from the keyboard.

To Enable extended freq coverage - 75 to 195, 200 to over 900 Mhz.

Hold down Light, and B and turn on, wait for display to stop.

To enable 10 and 100 Mhz digit entry direct from keyboard:

Hold down light and 2 key and turn on, then turn off.

Hold down light and 3 key and urn on.

Gud luck @ 73 Ron, N5WX

VE3PZR de VE3GYQ: at 0221z on 900508 B,C,D,H,?,I,J,K,L,M,N,P,R,S,T,U,V,W >  
bb

AX25 session 1 closed: Normal

Hit enter to continue



8506r 8506  
Date: 03 Sep 90 16:31  
Message-ID: <22513@VE4KV>  
From: VE4KV@VE4KV  
To: ALL@ALLONT  
Subject: Mod for IC-24AT  
Path: VE3EUK!VE3INF!VE3FJB!VE3KYT!VE4KV

#### OUT OF BAND MODIFICATION OF THE ICOM IC-24AT

The Icom IC-24AT is truly a remarkable unit. Having it's genesis in the IC-R1, Icom's extremely wide band Hand Held Receiver, it is capable of receiving a wide range of frequencies, as well as being able to transmit on short excursions, outside of the amateur two meter and 440 MHZ. bands.

The more current models can be modified to receive out of band, by a simple software (not necessary to physically open the transceiver) procedure as follows;

- o Turn the power switch off. While simultaneously holding the "light" button, the "B" button, and the "#" button, turn the radio on. All elements of the display will light up. Continue holding the buttons until the display goes out. It may be helpful to have a buddy give you an extra hand during this procedure....Your unit will now receive out of band.

The older models of this transceiver, require the removal of diode D13, before performing the above procedure. D13 is on the main logic board and is a discreet diode near the center of the board. It is the diode on the left of the two on the board when the radio is open and held with the controls away from you.

The "stock" transceiver, was also not designed, to provide full direct keyboard entry of the operating frequency. This can also be modified by one or both of the two procedures below;

- o To directly key in the 10Mhz. frequency, simultaneously hold the "light" button and the "2" button, while turning the radio on.
- o To directly key in the 100Mhz. frequency, simultaneously hold the "light" button and the "3" button, while turning the radio on.

The modification of the unit to enable it to transmit out of the amateur bands is a fairly simple procedure. It is however, complicated by the fact that the construction technique used in this transceiver is "Surface Mounted Technology." If you have no experience dealing with this technology, you may well be better advised to defer this procedure to someone who has. It is extremely small and delicate, and is best done with specialized equipment. Also, because the unit may not be FCC type accepted for all the frequencies on which it can then transmit, it may not be legal for you to use it, despite the fact you may be licensed to transmit on those frequencies. This information is provided

only for those who are licensed for and want to use the unit on MARS and CAP frequencies, where there are no type acceptance restrictions. The procedure is as follows;

- o Order a couple of DA204u diodes from Icom or your Icom dealer. These are a special three terminal device with two diode in one package. They are very very small, about half the size of one of the key buttons on the touch tone pad.
- o Locate and remove the diode device in position D8
- o Locate the vacant position of diode D7 and attach one of the DA204u diodes at that location.
- o Locate the vacant position of diode D12 and attach the other DA204u diode at that position.
- o If diode D13 (procedure above) has not been removed, remove it.

The unit will now transmit out of the amateur bands.

The IC-24AT can also function as a Mini Repeater transmitting on the UHF band while simultaneously receiving on the VHF band, or vice versa. This procedure requires both a small hardware as well as a software modification, and is performed as follows;

- o Locate diode D14. It is located adjacent to the location for diode D13 (see above procedure). Clip or remove it.
- o To enable Mini Repeater operation
  1. Push and hold the "Function" key and then the "C" key.
  2. Push and hold the "Function" key and then the "5" key and the "D" key.
- o To cancel the Mini Repeater operation, push and hold the "Function" key and then push the "D" key.

The above modifications provided the following capabilities with my particular unit.

FREQUENCY COVERAGE  
(VHF)

| RECEIVE                  | TRANSMIT                |
|--------------------------|-------------------------|
| 74.9 Mhz. - 127.9 Mhz.   | OFF                     |
| 138.0 Mhz. - 168.0 MHz.  | 138.0 Mhz. - 159.0 Mhz. |
| 174.1 Mhz. - 189.69 Mhz. | OFF                     |
| 200.0 Mhz. - 287.22 Mhz. | OFF                     |
| 310.0 Mhz. - 349.0 Mhz.  | OFF                     |

(UHF)

|                           |                         |
|---------------------------|-------------------------|
| 355.0 Mhz. - 409.98 Mhz.  | OFF                     |
| 412.37 Mhz. - 498.0 Mhz.  | 410.5 Mhz. - 470.0 Mhz. |
| 792.85 Mhz. - 966.66 Mhz. | OFF                     |

Receive sensitivity throughout both of the Ham bands was better than .5 of a microvolt. Sensitivity in the 200 Mhz. range was a disappointing 1 millivolt and in the 800 Mhz. band a good .7 of a microvolt. Remember, while the unit will receive on those frequencies, it is illegal to monitor cellular telephone communications.

Good luck with your unit.

"73"

Joe Taylor, W9JO





Date: Wed, 18 May 88 10:25 EST  
From: <REID@IUBACS.BITNET>  
To: MBRAMWEL@BUSINESS.UWO.CDN

Subject: ICOM IC-28A AND IC-28H

To make the IC-28 transmit 138-174 MHz, cut D21 (no retuning required). D21 is a tiny glass diode standing on-end near the center of the upper circuit board, accessible by removing the top cover. The IC-28 is the only convertible ham rig I know that covers the 170-MHz federal government (including national park) frequencies.

[source: W9MKV]





Newsgroups: rec.radio.amateur.misc  
From: wa2ise@cbnewsb.cb.att.com (robert.f.casey)  
Subject: mars/cap mod file for the IC2AT  
Message-ID: <1992Jan12.201713.26613@cbfsb.att.com>  
Keywords: mod file  
Sender: news@cbfsb.att.com  
Organization: AT&T Bell Laboratories  
Date: Sun, 12 Jan 1992 20:17:13 GMT  
Lines: 49

copied from packet:

| Msg#  | TSF | Size | #Rd | Date   | Time | From  | MsgID     | To             |
|-------|-----|------|-----|--------|------|-------|-----------|----------------|
| 10043 | BF  | 2566 | 1   | 27-Dec | 2052 | N2MOD | 2631_NY2S | MODS@ALLUSA () |

Sb: Icom IC-2AT MODs.

#### MODification File For ICOM IC-2AT

-----

If you have studied the schematic diagram for this radio, you will notice that pins 15 and 16 are not indicated on the programmable divider chip IC1 (TC9122). By simply connecting pin 15 thru a switch to pin 1, you will be able to move the radio up in frequency by 10 MHZ.

Some of these radios were sold without covering 140-150 MHZ. The modification for this extended coverage is described below:

- 1) Open up the radio and locate the FLEXIBLE BOARD, this connects the thumbwheel switches to the MAIN BOARD.
- 2) At the MAIN BOARD end of the FLEXIBLE BOARD, add a jumper at location C4. There should already be a jumper at location C2.
- 3) At the thumbwheel switch end of the FLEXIBLE BOARD, remove the jumper which connects C3 and COM.
- 4) Reassemble the radio. Coverage is now 140-150 MHZ. (MARS/CAP)

Now, if you activate the switch described above, the radio will now operate in the 150-160 MHZ range, after L3 adjustment, described below.

#### OPERATION and L3 ADJUSTMENT:

-----

- 1) Activate switch and dial up a known active frequency.
- 2) Adjust L3 until PLL locks up and radio begins receiving. (you need an active frequency to tell when this happens)
- 3) To return to 140-150 MHZ, repeat above steps with switch off.

#### NOTES and DISCLAIMER

-----

- 1) Drill a hole in the case of the radio so that L3 can be adjusted from outside of the radio.
- 2) The above information is presented for educational purposes only, and is not an endorsement of any particular practice.
- 3) This MOD has been in operation for 6 years with no ill effects on the radio
- 4) This MOD courtesy N2MOD.

---

Note: I haven't tried or verified this, proceed at your own risk. And do not transmit outside of legal bands! WA2ISE



From: commgrp@silver.ucs.indiana.edu  
Date: 5 Dec 89 09:46:00 PST  
Subject: ICOM 2GAT Mods

Fred, I got this off the news, I dont know if you care about it.  
Mike

P.S. Only for you information, I know you would never dream of doing this to a  
radio. :-)

---

>From: commgrp@silver.ucs.indiana.edu  
>Subject: Icom IC-2GAT out-of-band transmit m  
Message-Id: <12600087@silver>  
Date: 4 Dec 89 19:09:00 GMT  
Organization: Indiana University CSCI, Bloomington  
Lines: 43  
Nf-Id: #N:silver:12600087:000:1641  
Nf-From: silver.bacs.indiana.edu!commgrp Dec 4 14:09:00 1989  
Apparently-To: sanford

OUT-OF-BAND TRANSMIT MOD FOR ICOM IC-2GAT HANDHELD 2M TRANSCEIVER  
(copied from packet radio; origin unknown:)

Back side of display board:

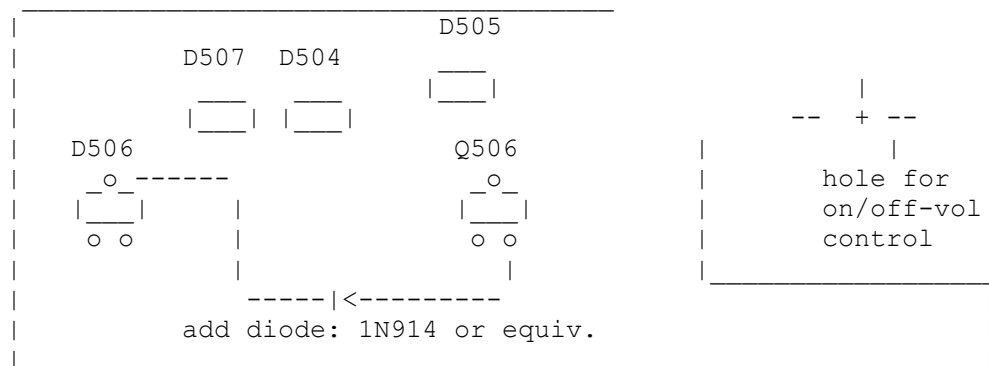

Connect diode between top lead of D506 and lower right lead of  
Q506 as shown.

Notes: D506 may be absent. If not, remove it.  
Reset CPU if needed.

---

A friend did this and his IC-2GAT can now transmit 138 to 178 MHz (no  
RF power output measurements were made). He did no retuning, and did  
not have to reset the CPU. He used a tiny axial-lead glass diode,

replaced its leads with wire-wrap wire, and encased it in shrink-tube. The operation requires a super-tiny soldering iron. Observe CMOS soldering precautions: Unplug the iron and ground the tip before touching the circuit.

Remember: Except for MARS and CAP, it is illegal to transmit outside the ham bands with non-type-approved equipment.

--

Frank      W9MKV      reid@gold.bacs.indiana.edu



Date: Sat, 24 Mar 90 15:00:22 EST  
From: mgb@tecnet1.jcte.jcs.mil  
Subject: IC-2SAT TX/RX mod

I read a posting a few weeks ago where a gentleman was interested in any mods for the IC-2SAT that extended transmit or receive frequency range. I didn't pay much attention to it then, but when the XYL got one for me as a birthday present... that attitude changed markedly! :-)

Well, I gathered up all I could find on the issue and broke out the soldering iron and took apart the radio that was less than one day old.  
(OH NO Mr. Bill!!!!)

Here's the straight scoop and I HAVE tried this but you still proceed at your own risk (in case you were so foolish as to not know that :-)

Take the battery cover off the bottom and remove the two screws.  
Remove two screws directly behind PTT button.  
Remove one screw where handy-carry strap goes.

Gently pull on the front half of the radio and the radio will split apart but don't pull TOO far because the front half of the radio is still attached to the back half with that flexible plastic film wiring stuff. Fold front half to the right and lay it down.

WARNING: The battery//cover release button can now pop out and a little itchy-bitsy tiny spring can take off for parts unknown. (Ask me how I know this... I spent 2 HOURS looking for that little sucker!) Pull the button out of the case NOW and watch out for that blasted little spring!

All work is done on the circuit board inside the FRONT half of the radio (the part that you just pulled off).

EXTENDED RECEIVE:

Look along the RIGHT side of the circuit board and about halfway down the right side you will see a tiny circuit board that is mounted VERTICALLY on it, aligned from top to bottom. Look at the TOP of this little tiny board and you will see a normal diode (D-9) that is vertically mounted on the vertical board. Sounds confusing, but you can't miss it, it's right on the top end of the board.

Cut this diode. Don't try to unsolder it... CUT IT. Take my word on it.

WARNING: Don't pull the diode away from the board and leave it hanging. When you put the radio back together it is a very close fit and if you short the diode, the radio won't work. The PLL stays unlocked but no damage will occur. (yeah, I did that too :-)

If you stop right here and reassemble the radio, you will now have extended RECEIVE capability after you reset the radio according to the instructions in the manual on the first page. And it REALLY is extended. My PLL was still locked up down around 88 Mhz and actually received FM broadcast stations although it obviously sounded BAD! :-)

The radio freq. read-out now will go all the way up past 1 GHz, but that's just the dial read-out, check the Channel Indicator and when it goes to a "U" for "Unlocked" you



can keep an eye on PLL performance, however I was amazed at where the PLL was locking up and the fact that it was actually receiving (albeit poorly) across a very very wide range. Yes, of course the sensitivity is way down the further you wander from the 144-148 design frequency range but it still is pretty impressive, and the new freqs. can be stored in memory and scanned.

EXTENDED TRANSMIT:

Look for the big IC directly in the middle of the main board on the front cover (IC-1 40608). Go to the bottom right corner of it. Move your eyes slightly to the right and you will see three chip resistors in a row. Just to the right of THOSE you will see three silk screened dots that are bracketed by a rectangle of white ink lines where a factory diode package would have gone. The "dots" form a triangle with one at the top and two at the bottom. Install a diode (1N914 or equivalent) with the cathode on the TOP dot and the anode on the bottom left dot.

This will give you extended transmit from about 138-163 or so.

But if you believe that trying to get a diode in there (without shorting out a lot of stuff) is impossible, (and you are very close to being correct) then FORGET this approach. Instead get Icom's diode DA (# 1750000160) and install IT in the same place.

I tried using the 1N914, and it was a TOUGH job. It worked but looked horrible and was in imminent danger of falling off. I tried it out, verified that it worked... and pulled it right out. I have the diode DA pack on order now and will do it right when it gets here. I would politely suggest that you forget trying to use the 1N914 unless you have a micro-miniature repair facility at hand. (I did and still didn't like it).

To avoid hate mail .... I have to remind you that it is illegal to transmit on the air with this radio out of the Amateur Bands unless a legitimate emergency exists. (Type acceptance and all that.)

However if you (like me) plan on using it for a quick and dirty sig-gen into a dummy load, then it is the cat's meow!

Mark Bitterlich WA3JPY  
mgb@tecnet1.jcte.jcs.mil

-----











From: TPDugan@dockmaster.ncsc.mil (Tim Dugan)  
Newsgroups: rec.radio.amateur.misc  
Subject: Icom IC-2SRA Mods  
Date: 29 Mar 1992 20:09:48 -0800  
Organization: UCSD Usenet Gateway  
Lines: 145  
Sender: daemon@ucsd.edu (The Devil Himself)  
Message-ID: <920330040824.343731@DOCKMASTER.NCSC.MIL>  
NNTP-Posting-Host: ucsd.edu

I recently inquired about mods for the IC-2SRA, but didn't get any response, except for some requests to share anything I learned.

So I figured it out myself, and here they are:

IC2SRA Summary: Extended Receive, Extended TX (136-174 MHZ)

Modification Instructions for the Icom IC-2SRA Handheld

The IC-2SRA appears to be very similar to the IC-W2A, with a Wideband Receiver unit replacing the UHF RF unit. Not having an IC-W2A or the service manual for it, I can't be sure. This mod is very much like the IC-W2A mod by AA7BQ, which I used as a starting point.

#### Extended Receive

Right out of the box, the IC-2SRA Ham Band will tune 136-174 MHZ, and transmit 140-150 MHZ. Although the Receiver Band will tune 25-950 MHZ, sensitivity is better on the Ham Band side. Direct entry of frequencies outside of the amateur band is not as convenient as it could be. But there is an undocumented (by Icom) feature which makes it easier. Enable extended receive by holding down the 3, B, and # keys while turning on the power. Keep your fingers on the B and # keys for a minute, and you can see the full LCD function display. Besides what is normally seen, there are also VOX, TOT, RIT, and VXO displays. Makes one wonder if there are additional undocumented features? I haven't a clue! There are other key combinations which will do the same thing. With this done, the dial select step can be set to 10 MHZ, and the first digit for frequency input can be selected as 100 MHZ in SET mode. The display will now go from 50-500 MHZ, but don't think that you can receive in that range. You can believe signals in the 136-174 MHZ range, but outside of that you are most probably hearing images.

#### Extended Transmit

This is the fun part. The radio is designed to allow a wide range of applications, meeting amateur band requirements all over the world. This is accomplished with a diode matrix on the Logic unit. For the US, this involves diodes between lines D2 and 10 (D16), and between lines D3 and 11 (D22), on the Main CPU (IC2). To open up the full 136-174 MHZ range for transmit, diode D22 is removed, and diode D19 is installed between IC2 lines D0 and 11. The diodes are very small three legged surface mount components. Icom doesn't publish any information on the CPU logic (that I know of), so I'm not sure just why any of this works. But it does work!

Start by ordering one MA133 diode, order number 1790000860, from Icom America customer service in Bellevue, WA, at (206) 454-7619. Don't bother trying to order through one of the regional service centers, as they normally just forward part orders back to the corporate headquarters anyway. Cost in March 92 was \$2.43, plus \$1.75 handling. I don't know if they have a minimum; I ordered four diodes which brought the Visa charge to a little over \$10.00.

When the diode arrives, it's time to open up your radio. You need a set of small Phillips head screwdrivers which can be found at any Radio Shack. Remove the five screws on the back, and two smaller screws on the side of the case under the PTT switch. Don't worry about the screw for the handstrap, it is screwed into the metal back and comes off with the back. With the screws removed, the back is easily lifted off. This much is shown pretty well on page 57 of the instruction manual where it talks about installation of the UT-63 (which is already installed in the US version of the IC-2SRA). Now remove the UT-63, and the PTT rubber. In front of you is the Receiver unit, stacked on top of the VHF RF unit, which is on top of the Logic unit. That is where we need to end up, so start disassembling. The Receiver unit is held to the VHF RF unit by a small screw on each side. You won't have any trouble figuring out which ones they are. There is also a small screw at the bottom of the Receiver unit, which fastens a spring clip holding the two units together. Remove the screws, and keep track of them. Both units are then individually removed by gently unplugging them from the Connector unit with a down and out movement. At this point you should be impressed by the well thought out design of the radio, and the ease with which it can be taken apart. In front of you now is the Logic unit, but there is a plastic encased metal foil, the CPU shield, still in the way. This shield is under the wiring harness between the Logic unit and the Connector unit. It isn't attached to anything, and can be gently curled and slipped out to the right.

Here's kind of what you'll see under the CPU shield:

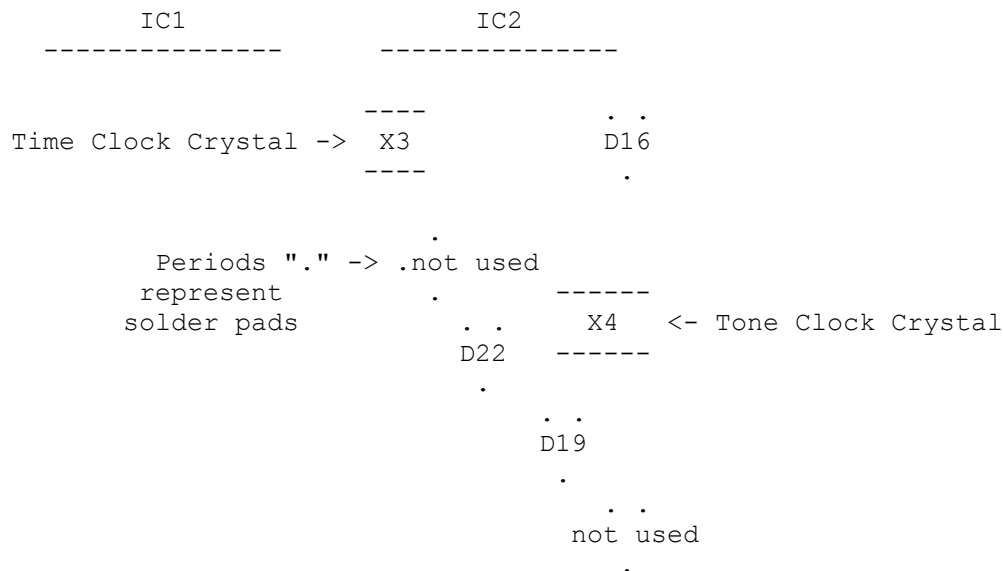

Now the fun really begins! The diode that you received in the mail, and the one that you have to remove, are very small. They are also quite



rugged, so don't let the size intimidate you. You do need to be clever about it though, and there is certainly more than one right way to go about it. You need a magnifying glass of some sort, and a fine tipped soldering iron. I wrapped a piece of solid No. 12 copper wire tightly around the tip of my 25 watt Weller. I brought a one inch lead straight out from the tip, and filed the end smooth. Ready for pin point soldering, start by removing diode D22. I put a knife blade under one end and applied light pressure while touching my No. 12 tip to the diode lead closest to the knife. Then the next lead, and the last one. Pops right off with no problem. You're not going to reuse it (unless restoring to original configuration), so it doesn't matter if it does get dinged up a bit. With D22 out, all that's left is installing D19. I used a pair of tweezers to place the diode in position, with the three leads sitting on top of the little blobs of solder already on the board. Then gently holding the diode in place with a toothpick, I tacked each lead in place. Don't add any solder, there's enough on the board already to do the job. After one lead is tacked down, the diode will stay in place without the toothpick. As I said, there are other ways to go about installing this very tiny diode (actually there are two diodes in the little chip), so do what makes you comfortable. Or find a friend with a steadier hand to do it for you!

Now you just put it all back together again, starting with the CPU shield. If you have trouble sliding it into place, you might be trying to put it between the wiring harness and it's plastic backing.

After the extended transmit mod the CPU resets itself (at least it did for me), but now you have the same features provided by the extended receive mod, without having to repeat the mod. You also can transmit 136-174 MHZ. As to be expected with a unit designed with 145 MHZ as the center frequency, performance varies. At 145 MHZ my handheld put out 7 watts into a dummy load. It does that throughout the 2 meter amateur band. At the ends of the "designed" transmit range, 140 and 150 MHZ, the power is down to 6.8 watts. Dropping down from 140 to 136 MHZ, the power is down to 6.2 watts. Going up from 150 MHZ, I got readings of 5.75 at 155, 4.25 at 160, 3.2 at 165, 2.2 at 170, and 1.75 watts at 174 MHZ. These readings are with a Radio Shack meter, so your mileage may vary. Nevertheless, a remarkable radio!

Enjoy, and please don't transmit on frequencies you're not licensed for!

Tim KA3YYP TPDugan@dockmaster.ncsc.mil



Date: 16 Mar 89 14:40:44 GMT  
From: SV1IW@SV1IW  
Subject: IC-32 Mod

Hello everybody, new radios are getting more and more complicated, don't you agree?

Here is a modification for the new Handheld Icom xcver IC-32 which will make it to act as a cross band repeater!

1. First take off the battery pack.
2. Remove the 4 screws from radio's back.
3. Remove two screws above and below the PTT and take the whole thing off so the four microswitches are revealed.
4. Take carefully the radio apart by slightly pushing away the front cover.
5. Put the two pieces in front of you with the front part at your left and the back at your right. Be carefull with the ribbon joining the two pieces!!! Orientation is as usual with the placethat the battery plugs down and the top of radio (i.e. where the antenna goes) up.
6. Find some pads with diodes in the lower right of the left part (front) of the radio below to the speaker.Take a look in the drawing below:

Top of the radio

```
[[->--[[           The number of diodes installed in the top 3 pads
[[->--[[           depends on the frequency coverage of the rig, maybe
[[      [[         two or all three.
```

```
_ZDDBD
_@DDAD
```

This is a small diode, by removing it the unit will receive from 300-370 Mhz but this is an untested mod!

```
[[->--[[           When you cut this one crossband repeater is enabled!
```

```
[[      [[         If you put this diode crossed and have full
                    frequency coverage not only you enable cross band
                    repeater but you can insert the frequency from the
                    keypad starting from second digit (without this mod
                    when you wish to insert a frequency in another
                    decade from the one you already are, you have to
                    go there manually).
```

Bottom of the radio  
where battery plugs

Last but not least to enable cross band repeating first choose a pair of frequencies with the two vfo's for VHF and UHF. Then press and hold function key while pressing with the other hand the following "C" "6" "D". The radio

will start scanning the two frequencies continuously, if a station is heard in one of the two it will retransmitted from the other! The two frequencies must be simplex, no cross band repeaters yet sorry!

Next John? >



Date: 18 Sep 89 08:39:55 GMT  
From: ka9q.bellcore.com!karn@bellcore.com (Phil Karn)  
Subject: Local packet QSOs / dual band rigs?

I also have the IC-3200A. The receiver recovery time with that radio is overly long. The fix is simple: open up the rig and remove diode D19 in the audio output stage. This diode biases the output stage off during transmit, but it is unnecessary because there are other audio gates ahead of this stage.

Phil



From: kral@larkan.dec.com (Larry NAMP)  
Subject: IC-32AT Modifications  
Date: 16 Jun 89 11:15:28 GMT

Here are 3 modifications for the IC-32AT, one was taken directly from an ICOM service bulletin. The following was partly done by NXION.

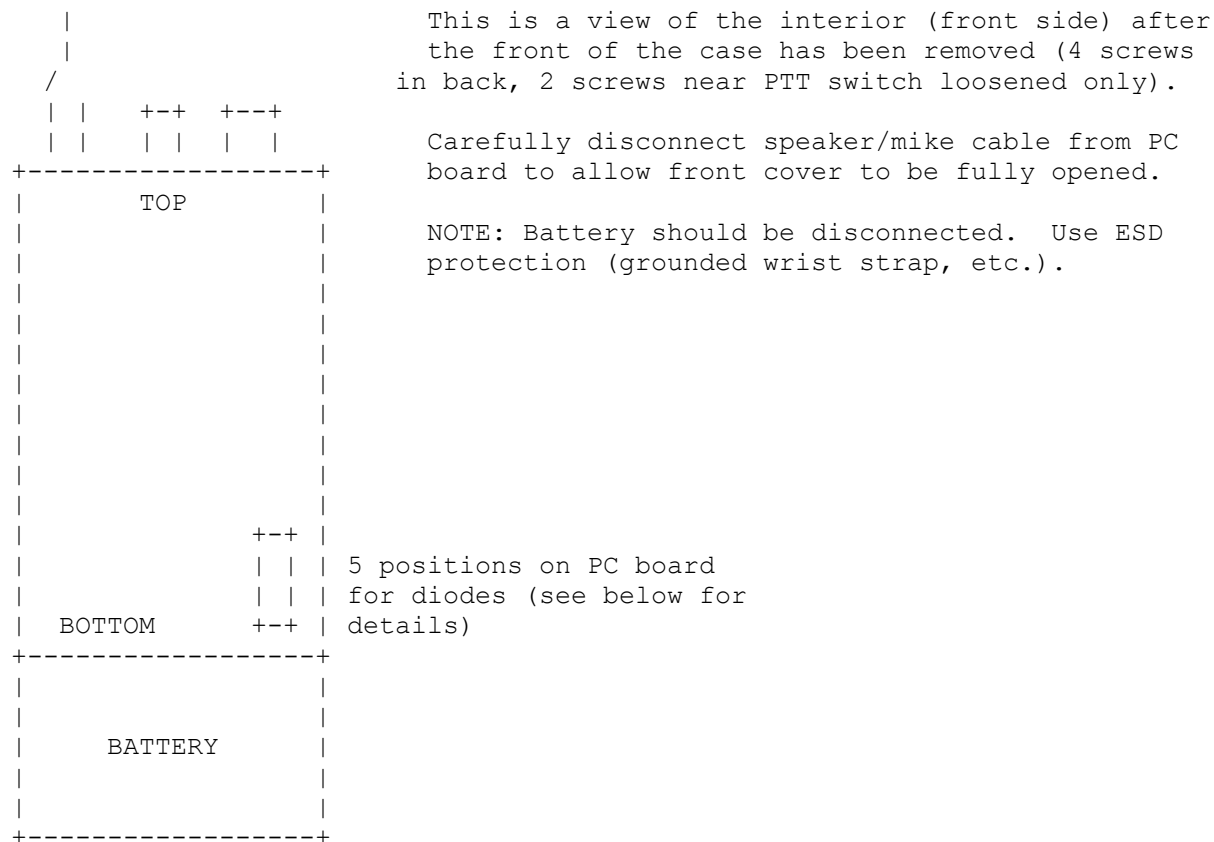

This shows diodes as installed at the factory.

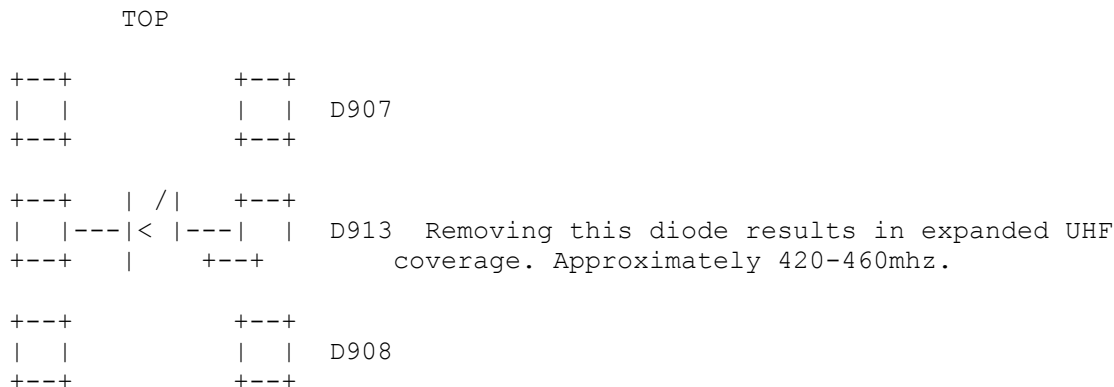



+---+ | /| +---+  
| |---|< |---| | D912 Removing this diode results in enabling  
+---+ | +---+ the unit as a cross-band repeater.

+---+ +---+  
| | | | D??? Installing a diode here (same polarity as  
others)  
+---+ +---+ permits keypad entry of 10mhz digit.

BOTTOM

Icom Service Bulletin #13889-005

The IC-32AT has the capability of being used as a cross-band repeater. This function is not enabled as the unit is shipped from the factory.

To enable this function perform the following steps:

- 1- Cut D912 on LOGIC UNIT. (see above figure)
- 2- Push and hold the (FUNCTION) switch.
- 3- Push the (C) key.
- 4- Push the (6) key.
- 5- Push the (D) key.
- 6- Release the (FUNCTION) switch.

To cancel "MINI REPEATER" perform the following steps:

- 1- Push and hold the (FUNCTION) switch.
- 2- Push the (D) key.
- 3- Push the (C) key.
- 4- Release the (FUNCTION) switch.



Date: 16 Oct 89 13:29:08 GMT

From: philmt1!philabs!briar.philips.com!rfc@uunet.uu.net (Robert

Subject: some IC37 mods

| Msg# | TSP | Size | #Rd | Date/Time | MsgID      | From  | To         |
|------|-----|------|-----|-----------|------------|-------|------------|
| 6051 | BF  | 2985 | 0   | 1010/0541 | 1631_N2EYR | W2JIA | ALL@ALLBBS |

Sb: IC37 mods.

Here is a list, transcribed from "220 Notes", of modifications for the ICOM model IC-37A. The 27A and 47A should be very similar:

"We have been using [this mod sheet] in the Southwest Coast ever since the [IC-]'37 was in production. This one is the latest revision.

"The design problems of the '37 are greater than ICOM would lead you to believe. The [IC-]'38 has solved a great majority of the '37a problems. However, the microphone and the UHF pigtail problems still remain.

"The fix for the microphone on both rigs is the same. [see below] The fix for the UHF pigtail on the '38 involves removing the pigtail, and installing a bulkhead chassis mount BNC connector in the hole left by the pigtail assembly. Some elongation of the BNC connector holes is necessary for a good fit. A short coaxial jumper may then be installed from the board to the connector.

"Now, here is the official Condor Connection IC-37 modification sheet.

"1. To restore high-frequency receiver audio response, replace C-103 on the main unit with a .0022 uf mylar capacitor (that's 2200 pf).

"2. To restore LOW-frequency receiver audio response, replace C-106 with a .22 uf mylar capacitor.

"3. To eliminate the distortion in the transmit audio, install a 4.7k ohm resistor inside the microphone case, in series with the white lead coming from microphone element. Once the resistor is installed, set the DTMF level pot to the middle of its range (this pot is the only one inside the microphone case). To complete the mod, set R88 inside the radio to the desired "mike" level.

"4. To improve the receiver sensitivity, power output, SWR at the radio, and reliability, remove the RG-58 pigtail and the UHF connector extending from the rear of the radio. Install a BNC chassis mount, screw-in connector (UG-1094/U) in the hole left in the back of the radio. The new connector will screw in as if the modification was done at the factory.

"5. To greatly reduce chassis heating in the receive mode, remove the following components: R66, R67, R68, Q32, D42,

and D44 in the main unit. Install a 7808 [3-pin voltage regulator] on the transmitter power amp shield behind the space reserved for the optional voice synthesiser. Thermal compound is recommended. Hook the input of the 7808 to the point where R67 and R68 used to connect. Hook the output of the 7808, in series with a 1N4001 diode, to J14-1. The cathode of the diode goes to the connector goes to the connector, and the anode goes to the 7808.

"---Mark Gilmore, WB6RHQ  
Newbury Park, CA."

One note on the above - the BNC connector mentioned for the x7-series radios is sold by Radio Shack as 278-105, \$1.39 each.

Note: I haven't tried these, proceed at your own risk. WA2ISE  
0158z, 1390 msgs, #6500 last  
@KD6TH-4 MailBox>



From: gettys@yacht.enet.dec.com (Bob Gettys)  
Subject: Icom IC-4SAT xtnded transmit mod - how to  
Date: 22 Jul 91 20:37:58 GMT  
Organization: Digital Equipment Corporation  
Lines: 71

Ok, I recently asked the net for mods to expand the transmit frequency coverage of the Icom IC-4SAT so that I could access the rest (or at least more ) of the 440 ham band below 440mhz. Well, the net didn't come through but a local ham made a suggestion to me that I followed up on. I mentioned that I had a mod (see attached message below) for the IC2SAT to expand its transmit range. He suggested that I look at doing the same mod (I know - it sounds crazy). Since I have the tech manual for both units

oked at the 2S manual to see what the mod was doing. I then looked at the 4S manual to see if things were similiar. To my suprise (although in retrospect I'm not suprised, just suprised that I didn't think of it) the microprocessor section is IDENTICAL wi th only the initialization matrix of diodes being different between the 2S and the 4S. Even the part numbers of the micro were the same (led me to believe that the code is the same in both). So I tried the mod explained below.

Bottom line - it worked!! I get about 30 mhz of lock range from about 435mhz to 465mhz. My next step will be to look at retuning the vco to move it down in the ham band more.

/s/ Bob Gettys N1BRM

Thanks to David Thomas whose 2SAT mod is attached below for posting it last fall.

-----  
From: dt@yenta.alb.nm.us (David B. Thomas)

=====

I have just discovered a way to turn off the policeman in the 2sat that stops the transmitter from operating outside of 140-150 Mhz. The only limitation is now transmit VCO lock range, which, out of the box, is about 137 to 162 mc. I'm sure by tuning a slug one could raise or lower this coverage "window".

To do the mod, you'll need a soldering iron with a VERY fine tip, some fine solder, some small screwdrivers, a 1N914 diode (or other small silicon diode), some fine (wire wrap) wire, and (probably) a magnifying glass!

Follow the directions on page 34 of the instruction booklet to take the unit apart. This allows the front panel to be removed from the radio. No further







Article: 17737 of rec.radio.shortwave  
Path: news.cs.tut.fi!news.funet.fi!sunic!mcsun!Germany.EU.net!news.netmbx.de!  
mailgrzr.TU-Berlin.DE!math.fu-berlin.de!ira.uka.de!sol.ctr.columbia.edu!  
howland.reston.ans.net!usc!elroy.jpl.nasa.gov!ames!sun-barr!  
news2me.EBay.Sun.COM!exodus.Eng.Sun.COM!newbirth!rja  
From: rja@newbirth.Eng.Sun.COM (Robert Allen)  
Newsgroups: rec.radio.shortwave  
Subject: ICOM ICR7100 RECEIVER (365 lines)  
Date: 29 Jan 1993 01:56:26 GMT  
Organization: Sun  
Lines: 346  
Message-ID: <lmh3maINN74q@exodus.Eng.Sun.COM>  
References: <SWL-L%93012803494166@OHSTVMA.ACS.OHIO-STATE.EDU>  
NNTP-Posting-Host: newbirth

In article <SWL-L%93012803494166@OHSTVMA.ACS.OHIO-STATE.EDU> Francesco Bosio  
<CALCOX@UNI-BOCCONI.IT> writes:

>Hi all  
>

>I'm considering to change my actual scanner (AR 1000) with an  
>ICOM IC-R7100. I would like to hear any impression about it.  
>Is it a good choice ? What else do the market offers for the  
>same price/performances ?

Here is my accumulated net data on the R7100:

Article 853 of alt.radio.scanner:  
Newsgroups: alt.radio.scanner,rec.radio.shortwave  
Path: exodus.Eng.Sun.COM!jethro.Corp.Sun.COM!news2me.ebay.sun.com!sun-barr!  
decwrl!mips!nec-gw!netkeeper!vivaldi!rsd0!rsd.dl.nec.com!dave  
>From: dave@rsd.dl.nec.com (Dave Rogers)  
#Subject: Re: Has Anyone Purchased An ICOM R7100 Yet?  
Message-ID: <1992Jun8.133057.23728@rsd0.rsd.dl.nec.com>  
Sender: usenet@rsd0.rsd.dl.nec.com  
Nntp-Posting-Host: rsd22.rsd.dl.nec.com  
Organization: BINJFBA Society  
References: <1992Jun5.173215.8369@cbnewsc.cb.att.com>  
Date: Mon, 8 Jun 1992 13:30:57 GMT  
Xref: exodus.Eng.Sun.COM alt.radio.scanner:853 rec.radio.shortwave:16072

In article <1992Jun5.173215.8369@cbnewsc.cb.att.com>, rats@cbnewsc.cb.att.com  
(ICOM ICR-70) writes:

|>  
|> I haven't seen any evaluation of the R7100 VHF/UHF receiver here,  
|> or in any hobbyist publication other than Bob Grove's Monitoring  
|> Times.  
|>  
|> If anyone has one, could they kindly share their experiences with  
|> said receiver?

My wife bought me one for my birthday last month. So far I am very  
pleased with it. One of my favorite features is "program scan auto  
memory write". This feature allows scanning between two scan limits with  
all hits saved to memory channels 800-899 (no dups). There are ten scan  
edge pairs for setting up continuous scanning between any two freqs.

Another great feature is the ability to store a "select code" with any memory channel. Select codes are "S" (skip) and 0-9. This allows you to scan for only select code 3, for example, so that you can categorize all memories and scan for them easily. This is important since there are 900 regular memories plus the ten scan edge pairs.

I have no way of judging the sensitivity, selectivity or IMD or the receiver but I can say it is more sensitive, selective and noise free than any of my ham band only VHF/UHF equipment. In fact it is my preferred receiver for 2m and 70cm.

Scan rates, delay times and many other features are programmable from the front panel.

It can be programmed to do both a primary scan (simple, normal scan) as well as a lower priority background scan. For example, say you want to scan the VHF area freqs from say 127-139 MHz to find out what was there and save any hits to memory while scanning the local trunked police freqs at 840 MHz. Simple. Program in the police freqs in say memories 100 thru 150. Program in the scan edges of the area band into one of the scan edge pairs. Then select programmed scan with advanced scan mode. Presto. While scanning the police freqs it will do double duty and check for any activity on the area bands. There are five simple scan modes and three advanced modes. Duty cycle of the foreground/background scans is, of course, programmable.

The computer interface is the same as previous Icom gear so you can control up to four receivers from a single computer port.

So far the only thing that I have a problem with is a relay cutting in when it switches above 800MHz (don't know the exact freq).

Finally since it is an all mode, continuous coverage receiver, there is absolutely nothing between 25 and 2000 MHz that you cannot receive.

They are extreeeeemly hard to get hold of. My wife bought mine through Grove. The Icom folks at HAM-COM '92 (Dallas) this weekend said that a certain US government agency had purchased several thousand of them because they were so much better than most of the milspec stuff...

=====

=

Dave Rogers  
M & R Software, Inc.  
Internet: dave@rsd.dl.nec.com  
On contract to: NEC America, Radio Software Dept

Article 16076 of rec.radio.shortwave:  
Path: exodus.Eng.Sun.COM!jethro.Corp.Sun.COM!news2me.ebay.sun.com!sun-barr!  
decwrl!sdd.hp.com!caen!kuhub.cc.ukans.edu!spssig.spss.com!uchinews!kimbark!  
gary  
Newsgroups: alt.radio.scanner,rec.radio.shortwave  
#Subject: Re: Has Anyone Purchased An ICOM R7100 Yet?  
Message-ID: <1992Jun8.162317.1453@midway.uchicago.edu>  
>From: gary@kimbark.uchicago.edu (Gary Mr.OS/2 Buchholz)  
Date: Mon, 8 Jun 1992 16:23:17 GMT  
Reply-To: gary@midway.uchicago.edu



Lines: 57

Xref: exodus.Eng.Sun.COM alt.radio.scanner:871 rec.radio.shortwave:16147

In article <1992Jun8.162317.1453@midway.uchicago.edu>, gary@kimbark.uchicago.edu (Gary Mr.OS/2 Buchholz) writes:

|> I had an ICOM 7000 and got rid of it for the following reasons  
|>  
|> 1) Scan rate way too slow - like a few channels per sec rather  
|> than 28-38 channels per sec typical of the PRO2006 and AR1000XLT.

Scan rate is programmable (without computer control) but the default is 14 channels/sec.

|> 2) No banks. "Categories.." in the R1700... I'll think about it ?

The 7100 has 9 banks of 100 channels each.

|> Most disgusting..  
|> 3) No freq centering on scan. My ICOM-7000 always stopped 5 Khz  
|> too soon. Not a problem with the PRO2006.  
|>

The AFC does freq centering and the step rate is programmable.

|> I think that if all you want to do is listen in on a few freqs then the  
|> R7000 (any maybe R7100) is a great "communications receiver". But, if  
|> you really want to scan, in my mind, the R7000 doesn't quite make it.  
|>  
|> Its computer-controlled scanning is anemic. Problem is that, since it does  
|> not use any "banks", it transfers VFO info across the serial port. This  
|> is way too slow... like 2ch/sec.  
|>

With computer control the scan rate can be as high as 1000 channels/sec (even on the 7000).

|> Fix these problems... and I'll buy one (again)  
|>  
|> Gary  
|>

The Icom 7000 and 7100 are not even remotely related (unless you consider Icom a relation :-). The 7000 was notorious for overheating and several other problems, however, I feel that they have all been fixed or improved with the 7100 and there are numerous bells and whistles on the 7100 that no other scanner that I have seen has (such as VSC) and the Icom Window Scan.

If all you do is listen to the local fire dept., then just about any old Rat Crap scanner 'll do.

=====

=  
Dave Rogers  
M & R Software, Inc.

Internet: dave@rsd.dl.nec.com  
On contract to: NEC America, Radio Software Dept

## COMPARING THE ICOM R7100 TO THE R7000 RECEIVER

by Bob Parnass, AJ9S

[Note: The following information is gleaned from 6 years experience with an R7000 and the past 3 days experience with a brand new R7100. -BP]

The radio RF/IF/AF portions of the R7100 are similar to the older R7000, but the R7100 is constructed using surface mount parts. Consequently, the R7100 is smaller. A-B tests indicate both the R7100 and Radio Shack PRO-2006 receivers are about equally sensitive, and more sensitive than the 6 year old R7000. Both the R7000 and R7100 are much more immune to intermod than the Uniden/Bearcat 760XLT and the portable PRO-43.

Many of the functions controlled by separate rotary switches and potentiometers in the R7000 are controlled by pushbutton switches and firmware in the R7100.

### Deleted Tuning Meter, Added AFC

Too bad the R7000's analog center reading meter function was replaced with 3 indicators on the R7100. The R7100 has an interesting AFC circuit, controlled by a front panel switch. The AFC will automagically tune the receiver close to the center frequency if you tune near an FM signal. You can watch the frequency change as the AFC steps the receiver in 100 kHz increments. The AFC never quite tunes to the exact center, but tunes within a window set by a difference amplifier circuit, so the station sounds good even though the R7100 is slightly off center frequency.

### Modes

R7000 and R7100 users have the same choice of modes, but they are easily selected from front panels controls in the new R7100. A rear mounted slide switch is used for USB/LSB selection in the R7000.

### Fancy Firmware for Memory Organization and Scanning

The firmware in the R7100 is much more sophisticated, and a brief article wouldn't do it justice. There are 9 banks of 100 channels. Further, you can associate each channel with 1 of 10 groups. There are many possible ways to scan, more than listed here. You can scan:

all channels  
all channels in a given group  
all channels in a given group in a given bank

all channels in a given emission mode  
all channels in a given emission mode in a given bank

As with most other scanners, there is a lockout bit for each channel, so you don't have to scan the NOAA weather channel even though you have it in memory.

There are 10 pairs of search limits. The search and store ("memory write") scan mode lets you store 100 frequencies instead of the 20 in R7000. Another R7100 improvement is that you can program up to 100 channels for the R7100 to skip while searching. I used this for searching for federal stations in the 162-170 MHz range while skipping the NOAA weather channels 162.55, 162.4, and 162.475 MHz, as well as some veteran's hospital paging channels.

The R7100 has 2 VFOs, but Icom calls them windows. There are several window scan modes, but they resemble priority scan modes in a Bearcat scanner.

#### New Memory Query Feature

The R7100, like the Bearcat 200xlt, has a feature which allows you to detect memory channels programmed with duplicate frequencies.

#### Tuning Step Selections

The R7000 tuning step size is selected using a rotary switch. The R7100 tuning step size is selected by using a pushbutton to step through the selections. The R7100 has more choices, including a 100 kHz step, useful for tuning around the aircraft bands.

Another new R7100 feature is that a tuning step size can be stored into each of the 900 memory channels, so when you use the tuning knob to tune off a memory channel, the R7100 tunes in reasonable increments (e.g., 12.5 kHz in the 450 MHz range, 10 kHz in the VHF-low band, etc.).

#### Rescan Delay Added, but Nondefeatable

Icom finally included a decent 2 second rescan delay in the R7100 which owners complained was missing from the R7000. Ironically, you cannot defeat the rescan delay in the R7100, so it's now more difficult to scan trunked systems in which the frequency changes with each new repeater transmission! It's ironic that the R7000 lacked a rescan delay.

### Power Supply and More

The internal power supply in both radios runs hot. The R7100 comes with a 12 VDC power cord included, an option in the R7000.

The R7000 comes with a handy carrying handle and rubber feet, an \$8.50 option on the R7100.

### Added Clock and Timers

Unlike the R7000, the R7100 contains a digital clock and timers which can be used to turn the radio on an off, and tune to different channels, several times each day. I probably won't be using timers, though.

### What to Buy

The R7100 is more complicated to use than the R7000. There are so many firmware controlled features and there are several 2 key sequences.

Faced with choosing between an R7000 or an R7100 in a similar price range, I prefer the R7100. Sensitivity aside, both are about equal communications receivers, but the R7100 is a better scanner, especially for finding new frequencies and organizing memory.

--

=====  
Bob Parnass, AJ9S - AT&T Bell Labs - parnass@ihlpm.att.com - (708)979-5414

--

Robert Allen, rja@sun.com

DISCLAIMER: I said it, not my company.

Samuel Addams: Brewer, Patriot.

right to be free!" - me

"The right to brew beer is the





Article 40159 of rec.radio.amateur.misc:  
Path: west.West.Sun.COM!news2me.EBay.Sun.COM!sun-barr!ames!agate!  
howland.reston.ans.net!gatech!concert!lester.appstate.edu!lester.appstate.edu!  
usenet  
From: HOFFMANMK@CONRAD.APPSTATE.EDU (Marvin Hoffman)  
Newsgroups: rec.radio.amateur.misc  
Subject: Need Help on Mod for Icom 725  
Date: 20 May 1993 20:04:12 GMT  
Organization: APPALACHIAN STATE UNIVERSITY  
Lines: 79  
Distribution: world  
Message-ID: <1tgo7sINN4a8@lester.appstate.edu>  
NNTP-Posting-Host: conrad.appstate.edu  
X-News-Reader: VMS NEWS 1.24

Can someone kindly help me with the missing step from the modification to the ICOM 725? I got the following mod from the n8emr mod server but it is apparent that something is missing in step 5 and step 11 appears to have something missing (besides being out of sequence).

Thanks,

Marv Hoffman, KD4EGV  
Appalachian State University  
Boone, NC

Bitnet: hoffmanmk@appstate  
Internet: hoffmanmk@conrad.appstate.edu

\*\*\*\*\*

From: IN%"MOD-SERVER@n8emr.cmhnet.org" 20-MAY-1993 14:25:50.72  
To: IN%"HOFFMANMK@conrad.appstate.edu"  
CC:  
Subj: /usr/bbsfiles/mods/ic725.mod Part 01/01

-----  
ICOM IC-725 MODIFICATIONS  
-----

MARS MODIFICATION  
-----

DISCLAIMER:

This modification allows the radio to transmit outside of the designated Amateur freq. Transmitting where you are not licensed to do so is unlawful!

Disassemble radio following instructions on page 24 of Instruction manual, steps 1 - 7, or as follows:

NOTE: All instructions with the radio's front panel facing you unless

otherwise specified!

- 1) Remove all black screws from top & bottom covers and remove both covers.
- 2) Remove the 2 flat head screws that hold the PA unit to the front unit.  
(top front of radio - Not the screws that are in the plastic front panel.)
- 3) Remove the 2 screws that hold the PA unit to the rear panel.  
(Looking at the rear of the radio, 1 is above the ext. speaker jack & 1 is above to ACC(1) jack.)
- 4) Unplug the 2 plugs from J11 & J12.
- 5) D
- 6) Disconnect the large black connector on the left side of radio.
- 7) Slide up and out, the TUNER CONTROL SOCKET from it's holder in the rear panel.
- 8) Remove the tape from the right side of the PA unit.
- 9) Swing the PA unit up to the left and lay over flat.  
located to the left side, rear of the board, next to J4.  
You may have to remove J4 to allow access to D-5.
- 11) Reassembly is As if you were  
opening a book! You now have the PLL unit exposed.
- 10) Cut Diode D-5 from the PLL unit.  
D-5 is loca reverse of above
- 12) The radio will now transmit from 1.5 MHz to 33 Mhz. (It will transmit even lower but the power output drops off and I don't know if doing so will damage the transmitter.



From: VK3CDE@VK3YZW  
Subject: ICOM 735 <-> IBM Notes

Hi All,

I have finally got the remote control working on the IC735. The interface is home-made and uses just 2 transistors, 1 diode, 5 resistors, DB25 and a DB15(to get 5v from games port). The software is a major re-hash of VK7TM's FT757 effort in ARA. All functions are driven from the XT keyboard and the software allows scanning of a LARGE number of frequencies on the same or on different bands.

The trials and tribulations of all this effort were NOT assisted in any way by the manufacturer's local office in Melbourne. A call for information was not very successful. (try it and see!)

If you are contemplating the idea of turning your IC735 into a multi-channel HF scanner, I may be contacted @ VK3YZW BBS..

The software is suitable for use with XT/AT Clone...

Available control functions:

Send a new frequency to the radio from the keyboard.

Send a new Mode to the radio.

Select VFO A or VFO B.

Select a different memory channel

Enable the selected memory channel

Write current Freq/Mode to selected memory channel.

Write current Freq/Mode to last used VFO.

Read/Edit/Use a frequency file from Disk.

SCAN frequencies in a frequency file.

The frequency files contain frequency/mode/description of station all of which is displayed on the screen when the file is active.

73, Bob VK3CDE





the wire inserted earlier with R29. All the components may be surface mounted if desired on the bottom of the main board, but I chose to perform this mod on the top of the board to allow easier removal of the main board for servicing. The long wire that was attached to the second diode and the resistor is routed to the empty pin on the split switch that is driven to ground when the switch is in the OFF position.

BUGS:

The CW VOX will be active when using split mode, even if neither the transmit or receive mode are the CW mode.

Enjoy, 73 de VE6MGS/Mark -sk-

From: jpd@pc.usl.edu (Dugal James P.)  
Newsgroups: rec.radio.amateur.misc  
#Subject: IC751 extension to 37MHz  
Message-ID: <1991Nov12.205246.21845@usl.edu>  
Date: 12 Nov 91 20:52:46 GMT  
Sender: anon@usl.edu (Anonymous NNTP Posting)  
Organization: Univ. of Southwestern La., Lafayette  
Lines: 97  
Originator: jpd@pc.usl.edu

[I'm posting this for Tom N5OFF -- n5knx, ed.]

IC-751 to 37 MHz de N5OFF@W5DDL.AARA.ORG

With a great amount of help from Mark, VE6MGS, I was able to modify my Icom 751 to operate at an extended frequency range of up to 37 MHz. This is how it was done.

Mark developed a clever way to read and interpret the contents of the Icom RAM chip (the old battery backed-up one) and alter its frequency limits in the GENERAL coverage and HAM modes. This was done in conjunction with the modification of his 751A to operate six meters. My interests are in listening to the low band skip present above the ten meter band during band openings, so I asked Mark for simply a new upper frequency limit, leaving the six meter mods to the very ambitious.

First, I changed the battery on my RAM board since mine was eight years old, and I didn't want Icom messing up my custom program if my battery died later.

I then shipped the board off to Mark, and he changed my GEN mode limits from .10-30 MHz, to .01 to 60 MHz (subject to VCO and RF limits, naturally). He also customized my HAM mode limits as shown:

| Before    | After       |                                                 |
|-----------|-------------|-------------------------------------------------|
| 1.8-2.0   | 27.98-30.62 | Default HAM mode selection<br>changed from 160M |
| 3.45-4.1  | 31.98-33.02 |                                                 |
| 6.95-7.5  | 33.98-35.02 |                                                 |
| 9.95-10.5 | 1.78- 2.02  |                                                 |

|            |             |
|------------|-------------|
| 13.95-14.5 | 3.48- 4.02  |
| 17.95-18.5 | 6.98- 7.32  |
| 20.95-21.5 | 9.98-10.17  |
| 24.45-25.1 | 13.98-14.37 |
| 27.95-30.0 | 18.05-18.18 |
| none       | 20.98-21.47 |
| none       | 24.86-25.01 |

These new HAM mode limits provide tighter control while hamming. Note the tight 12M and 17M limits. Much more realistic.

One problem encountered during the mod was that the rig's processor (IC-14) instructs the rig to select the proper VCO and bandpass filter for a given frequency, and it uses the highest BPF up until 31 MHz, then must be further instructed as to what to do at frequencies > 31 MHz.

IC-14 has several pins which turn on and off to do this instructing. Mark found that pin 18 (originally not used) of IC-14 turns on at >31 MHz. This could be used to turn on the highest BPF and VCO, thus allowing operation to higher frequencies. This was done physically by cutting the trace from pin 17's normal route, adding a diode to each pin 17 and 18 of IC-14, and joining the anodes of the two diodes to the circuit originally driven by pin 17, but now isolated by the trace cut. The effect is the use of the highest BPF and VCO until 31 MHz (pin 17) , and then the same BPF and VCO from 31 MHz and beyond (pin 18).

As expected, VCO4, as originally adjusted, dropped out at a low frequency (32.33 MHz). Since the VCO has a range of about 15 MHz (and was originally employed to cover only 8 MHz with 3.5 MHz of lagniappe on each end), and kicks in at 22 MHz, I adjusted it for a comfortable low limit of 22 MHz (with little margin), which lifted the upper range to a maximum observed limit of 37.175 MHz. This was done by giving C107 on the VCO unit 1/4 turn CW.

I haven't yet done any sensitivity measurements, as I'll have to borrow the equipment from my employer when its convenient for him. I don't know where, or to what extent the bandpass filter will cut off on the way to 37 MHz, if it does at all.

I believe the rig "hears itself" on a few certain frequencies, with strong signals at 30.715, 31.33, and 30.95. I believe this is normal as Icom probably moved these birdies to >30 MHz purposely. There are few other spurs.

CONCLUSIONS: I borrowed an R-7000 from a friend some months ago, and found that my favorite listening was in the lower 30's. Now, my 751 is as good to me as having my own R-7000 for what I would use it for. In the ham mode, its much easier to stay in the ham bands (especially WARC bands) with the new program, and the default band of 10M much more suits my tastes than the old 160M default band.

Thanks to VE6MGS [mark@ve6mgs.uucp] for his great help, without which I could not have accomplished this.



73 es bonne chance de tom N5OFF@W5DDL.AARA.ORG

--

|                                |                   |                                     |
|--------------------------------|-------------------|-------------------------------------|
| -- James Dugal,                | N5KNX             | Internet: jpd@usl.edu               |
| Associate Director             |                   | Ham packet: n5knx@k5arh             |
| Computing Center               |                   | US Mail: PO Box 42770 Lafayette, LA |
| 70504                          |                   |                                     |
| University of Southwestern LA. | Tel. 318-231-6417 | U.S.A.                              |



Date: Thu 9 Feb 89 12:02:25-PST  
 From: Brad Horak <BRAD@CSLI.Stanford.EDU>  
 Subject: Icom IC-900 mods  
 To: MBramwel@business.uwo.ca

Enclosed is a list of frequency range extension modifications for the IC-900. They are courtesy of KB1MZ and KA1OKQ. Some mods may enable out-of-band transmission. Transmitting there is ILLEGAL ! These radios are not type accepted so therefore it is ILLEGAL to use this radio out of the ham bands even if you have a license to do so. (ie volunteer F.D. etc). All mods are done at your own risk. This is in NO way an invitation to break the law. The mods are provided for information only.....73

Gene  
 WA1UXA

<Standard Disclaimer Applies>

#Subject: Icom IC900 mods

Frequency Expansion Modifications for the ICOM IC-900

All changes are made in the control head.  
 Diodes are arranged in a 8x4 array: A-H, 1-4.

As shipped from the factory, the diodes are arranged thusly:

X = diode in place

|     |     |     |     |     |     |     |     |     |
|-----|-----|-----|-----|-----|-----|-----|-----|-----|
|     | X   | X   |     |     |     |     | X   | 4   |
| --- | --- | --- | --- | --- | --- | --- | --- | --- |
|     | X   |     | X   |     |     |     |     | 3   |
| --- | --- | --- | --- | --- | --- | --- | --- | --- |
|     | X   |     |     |     | X   |     | X   | 2   |
| --- | --- | --- | --- | --- | --- | --- | --- | --- |
|     |     |     |     |     |     |     | X   | 1   |
| --- | --- | --- | --- | --- | --- | --- | --- | --- |
| A   | B   | C   | D   | E   | F   | G   | H   |     |

To add receive coverage on 6 meter and 70 cm bands only:

C=cut diode, or remove

|     |     |     |     |     |     |     |     |     |
|-----|-----|-----|-----|-----|-----|-----|-----|-----|
|     | C   | X   |     |     |     |     | X   | 4   |
| --- | --- | --- | --- | --- | --- | --- | --- | --- |
|     | X   |     | C   |     |     |     |     | 3   |
| --- | --- | --- | --- | --- | --- | --- | --- | --- |
|     | X   |     |     |     | X   |     | X   | 2   |
| --- | --- | --- | --- | --- | --- | --- | --- | --- |
|     |     |     |     |     |     |     | X   | 1   |
| --- | --- | --- | --- | --- | --- | --- | --- | --- |
| A   | B   | C   | D   | E   | F   | G   | H   |     |

440 Band - to expand coverage from 420 - 470 MHz:  
Remove diode D25 (3,D) for RX  
Install diode in (3,C) for TX  
VCO in 440 module covers a 20 MHz range - re adjust as needed.

220 Band - to expand TX coverage from 216 - 236 MHz:  
\* This mod hasn't been tried and verified. \*  
Install diode (1,C) for TX  
Remove diode (2,D) - ?

144 MHz Band - to expand TX coverage from 138 - 174 MHz:  
Install diode in (1,C)

50 MHz Band - to expand coverage from 40 - 54 MHz:  
Remove diode D32 (4,B) for RX  
Install diode in (4,A) for TX

28 MHz Band - to expand coverage from 28 - 40 MHz:  
Remove diode D32 (3,B) for RX  
Install diode in (3,A) for TX

-----



Newsgroups: rec.radio.amateur.misc  
From: Chuck Adams <chuck\_adams@qmail.ssc.gov>  
Subject: IC-901A Frequency Ranges  
Message-ID: <1992Oct6.135935.26944@sunova.ssc.gov>  
Sender: usenet@sunova.ssc.gov (News Admin)  
Nntp-Posting-Host: 143.202.130.11  
Organization: Superconducting Super Collider Laboratory  
Date: Tue, 6 Oct 1992 13:59:35 GMT  
Lines: 69

In article <ZD5XRB2w165w@n3eop.pgh.pa.us> paul@n3eop.pgh.pa.us (paul) writes:

>Does anyone know the extended range of the various IC-901A modules? I'm  
>particularly interested in the 10m and 6m modules... and how they relate  
>to the VHF-Lo band.  
>  
>Any other undocumented tricks with the '901?

Here are the frequency coverage ranges for the various band modules and the modifications to the control head diodes to get these extended ranges:

| Band | Range (MHz) | RX diode  | TX diode  |
|------|-------------|-----------|-----------|
| 10m  | 28-40       | 24 out    | 21 in     |
| 6m   | 40-54       | 28 out    | 26 in     |
| 2m   | 138-174     | no change | 18 in     |
| 220  | 216-236     | no change | 12 in     |
| 440  | 400-479     | 25 out    | 23 in     |
| 1200 | 1240-1300   | no change | no change |

To modify, remove the back of the control head and add or remove diodes from the marked pads as described in the above table.

notes: coverages are for RX. TX may not work over entire range, but will come close. RX sensitivity is front-end tuning dependant. 10m, 6m, 2m and 1200 modules will have OK RX sensitivity over most of their range. 220 RX sensitivity is unknown over its' range. 440 RX sensitivity will cover about 25 MHz with good sensitivity, tuning out of the box is from about 438-463. The 3 helicals can be retuned to any where in the 400-479 MHz range, but you can still only get the 25 MHz or so spread. If you have severe intermod problems while listening to 440 MHz frequencies, I would recommend retuning the helicals down in frequency to attenuate the strong 450-460 MHz signals from the front end. The intermod will almost completely go away. Of course, the sensitivity above 450 MHz will suffer, but most of the signals you would probably be interested in listening to will probably be quite strong to start with, so you will probably still hear them just fine. If you have access to a tracking generator and spectrum analyser, there is a small two pin jack on the UHF board from which you can monitor the helical response. Connect the tracking generator to the antenna jack and the spectrum analyser to the two pin jack.

Other '901A tricks:

Memory and microprocessor reset - turn power on while holding down check and

memory write buttons.

Crossband repeat - turn power on while holding down check and lock buttons.

If

crossband repeat has been engaged, the "lock" display will flash. PL can not be selected in either band for crossband repeat to work. If you need PL to operate the repeater you are linked to, generate it on the radio you are using to talk to the 901. The PL will pass through the 901 just fine to access the linked system. Since the radio is in the locked mode, you can't change frequencies or bands during crossband repeat. To disengage crossband repeat, turn off power or press lock button. If there is no audio during crossband repeat, open up the front of the dual-band unit by removing the plastic cover behind where the control head would plug in if the 901 is not used in the remote-control head configuration and look for a slide switch mounted on the edge of one of the vertical circuit boards and slide it the other way. The switch does not seem to come in any pre-determined configuration from ICOM, so some radios work OK for crossband repeat right out of the box, and some require the switch to be in the opposite position.

I would be very interested in any other mods or tricks for the 901.

Chuck Adams, WB5WRR (The Chuckster)

Not an official document of DOE, SSCL, URA or EG&G

"I cut you three ways, man: quick, deep and frequently"

Internet: chuck\_adams@qmail.ssc.gov





Date: 17 May 90 15:54:21 GMT  
From: hpcc01!col!kenw@hplabs.hp.com (Ken Wyatt)  
Subject: IC-24AT Receive Mods

At the request of several interested hams, I am posting the modification instructions for the Icom IC-24AT. This set of instructions originated from Icom America and was downloaded from the Icom Library of HamNet (Compuserve).

Ken WA6TTY (kenw@col.hp.com)

---

#### IC-24AT Undocumented Features - (from ICOM)

The IC-24AT dual band handheld had three additional features that are not described in the owners manual. These have been left out of the owners manual because some countries restrict the use of the radio in these modes.

#### AM AIRCRAFT RECEIVE PLUS 740 to 960 MHz RECEIVE

Remove D13 from the main logic board (this diode may already be removed by ICOM in some units). This diode may already be removed in some radios. D13 is on the main logic board and is a discreet diode (one of the two in the radio) near the center of the board. It is the left discreet diode of the two on the board when the radio is open and held with the controls away from you.

Simultaneously hold "Light", "B", and "#" keys depressed and turn power on.

It is important to note that the radio will not meet specification on the out of band receive frequencies that are enabled with this modification.

#### DIRECT KEYBOARD ENTRY of 100 MHz FREQUENCY

Simultaneously hold "Light" and "3" keys depressed and turn power on.

#### CROSS BAND REPEAT (simplex)

Remove D14 from the main logic board (this diode may already be removed by ICOM in some units). The diode is a discreet diode to the right of D13 (from above) and directly beside it.

Simultaneously hold "Funct" depressed and push "C".

To turn on cross band repeat:  
Hold "Funct" depressed then push "5" and then push "D".

To turn off cross band repeat simultaneously hold "Funct" and "D"

depressed.

2-14-90

-----



Subject: BAND EXPANSION MODIFICATION FOR ICOM MICRO2 =====

1. Remove battery.
2. Remove 4 screws securing battery. Slide from front panel.
3. Remove small black screw below PTT switch.
4. Carefully separate the front speaker from the body by pulling front and rear down toward battery. Flip it over.
5. Next remove steel chassis assembly by gently prying up the sides, lift up, fold it down.
6. Solder in new diode next to Q131 and Diode D113. Looking at Diode Matrix with top of radio to the top, add diode to the empty pad to the left of diode D119. There are 3 points of connection on the diode pad. Two on the left and one centered vertically on the right. The diode should be installed between the lower left and the right centered connection. (Arrow on diode points to right centered connection.)
7. Reset CPU by following instruction manual page 23.

-----  
\*\*\*->Be careful not to transmit out-of-band, or accidentally operate on any non-amateur, unless you are authorized to do so.

DO NOT JEOPARDIZE YOUR LICENSE!

[EOF]



Newsgroups: rec.radio.amateur.misc  
From: dmeer@afit.af.mil (David E. Meer)  
Subject: ICOM P2AT keyboard mods  
Message-ID: <1992Sep10.124554.28299@afit.af.mil>  
Originator: dmeer@scgraph  
Keywords: ICOM, P2AT, HT  
Sender: news@afit.af.mil  
Nntp-Posting-Host: scgraph.afit.af.mil  
Organization: Air Force Institute of Technology  
Distribution: usa  
Date: Thu, 10 Sep 1992 12:45:54 GMT  
Lines: 45

There was a recent posting requesting mods to the ICOM P2AT. I received the following info from ICOM Customer Service and they work fine on my P2AT:

To enable wideband receive and direct keyboard entry of the entire frequency:

with the HT off, hold down "Light" "B" and "#" keys and turn the HT on

Get into the set mode and you will have a new option labeled "PL". Turn the upper right knob to change this to a value of 100. (The rep at ICOM said "PL" stands for "decimal placement")

Get out of set mode

You should now be able to enter VFO mode and just press seven digit keys to enter any freq directly. I don't have mine with me now, but I think you can enter any freq from 0 to 1GHz (within PLL Lock range).

Dave Meer, N6KEF



From: billp@col.hp.com (Bill Pherigo)  
Subject: ICOM 32AT MODS  
Date: 21 Apr 89 18:54:19 GMT  
Organization: HP Colorado Springs Division

#### MODS FOR ICOM 32AT

1. Remove battery and antenna.
2. Loosen two screws on top of unit as much as possible without removing them.
3. Loosen 4 flat head screws on bottom of unit 1 turn.
4. Loosen 2 screws near PTT switch 1 turn.
5. Remove 4 black screws on back of unit.
6. Lift bottom of front cover .25 inch, slide it down .25 inch, then lift front cover up 1 inch.
7. Disconnect plug on 4 wires coming from the speaker.
8. Lay front panel on table up-side down being careful of the flex circuit.
9. All mods are done to the back of the front panel. Notice places for 5 axial diodes, which I will call 1 through 5, 1 being nearest the display. Add/remove diodes so there are diodes in positions 3 and 5. This will open up receive coverage for VHF & UHF and enable keyboard entry of the 10 MHz digit.
10. Notice 4 surface mount resistors slightly left of center directly above the speaker, lined up in a row. Solder the anode (the side without the bar) of two diodes to the right side of the lower of the four caps. Now find the CPU. It's the PGA under the shield near the top of the board. Find the row of pins on the CPU nearest the speaker. Notice the the 8th pin from the right has a thicker trace coming from it. Now notice that there are small solder pads about .25 inch toward the speaker on both the fat trace and the two traces to the right of it. Solder one each of the cathodes of the 2 diodes to the solder pads on the two smaller traces. This will open up the transmit for VHF & UHF.
11. Put unit back together in reverse order.

This procedure worked for my unit (and many others), but I can't guarantee it will work for yours.

Bill Pherigo  
WROY





Path: njitgw!njin!princeton!udel!haven!boingo.med.jhu.edu!aplcn!  
uakari.primate.wisc.edu!sdd.hp.com!hplabs!hpl-opus!hpnmdla!glenne  
From: glenne@hpnmdla.HP.COM (Glenn Elmore)  
Newsgroups: rec.ham-radio  
Subject: Xmit Mods for IC-735  
Message-ID: <1250346@hpnmdla.HP.COM>  
Date: 29 Jan 91 17:24:38 GMT  
References: <12450@lanl.gov>  
Organization: HP Network Measurements Div, Santa Rosa, CA  
Lines: 29

> In rec.ham-radio, stevens@mpx1.lampf.lanl.gov (Stevens, Thaddeus C.) writes:  
>  
>  
> I'm posting this for a friend who is looking for out of band xmit mods  
> for his IC-735.  
>  
> Any help would be appreciated.  
>  
> Thanks es 73's

Thad

I don't have either one of my 735's open and I can't seem to find the  
precise location or information but roughly...

There are two diodes, D30 & D31 (or maybe it's D32&D33 D34&D35 I can't  
remember) located toward the front center of the board containing the  
CPU. The diodes were end mounted with yellow insulation over the end of the  
leads away from the board. Cutting these diodes out of the circuit enables  
broadband transmit. My radios were purchased new in spring of 1989 so  
I don't know if they accurately reflect current production units.

This is a particularly nice feature since it allows wide coverage when  
used with transverters. I use my 735's with my 144MHZ - 10.368 GHz  
transverters  
with the radios operating in the 20-30 MHz region. It allows 10 MHz of  
all-mode coverage on every vhf-uhf-uwave amateur band.

73

Glenn Elmore n6gn

From glenne@hpnmdlcl.hp.com Mon Feb 4 12:27:19 1991  
Received: from hpnmdla.hp.com by relay.hp.com with SMTP  
(16.5/15.5+IOS 3.13) id AA13762; Mon, 4 Feb 91 09:26:55 -0800  
Received: from hpsrgee by hpnmdla.nmd.hp.com; Mon, 4 Feb 91 09:26:53 -0800  
Received: by hpnmdlcl.hp.com; Mon, 4 Feb 91 09:28:26 pst  
From: Glenn Elmore <glenne@hpnmdlcl.hp.com>  
Message-Id: <9102041728.AA03332@hpnmdlcl.hp.com>  
#Subject: Re: Xmit Mods for IC-735  
To: cdp@hertz.njit.edu (Chris Peckham) (Chris Peckham)  
Date: Mon, 4 Feb 91 9:28:24 PST  
In-Reply-To: <9102041638.AA11972@hertz.njit.edu>; from "Chris Peckham" at Feb  
4, 91 11:38 am  
Mailer: Elm [revision: 64.9]  
Status: OR

>  
> Do you have any documentation and/or suggestions on how to build or  
> design the 50 MHz through 902 MHz units ?  
>  
>  
Chris

I don't have anything explicitly written but it is very much along  
the lines of the microwave stuff I showed.

The LOs are partly there already:

| Band | LO      | circuit                                                                                                       |
|------|---------|---------------------------------------------------------------------------------------------------------------|
| 50M  | 30M     | 3 X 10 (2n5179 tripler from 10M)                                                                              |
| 144  | 120M    | I'm presently using the 100 MHz Xtal circuit<br>with a 120 M xtal but 6X20M with filtering<br>would work too. |
| 220  | 200M    | 2X 100M (single stage of 2n5179)                                                                              |
| 420  | 410/420 | Just like 260M LO shown                                                                                       |
| 900  | 620M    | Like 1010M 6th harm of 100M and 20M PLL reference                                                             |

Only 420 and 900 even need to use another of the PLL boards. The others  
just take a single stage. I have 50,144 and 220 done. 400 is sitting  
90% completed. I have PA bricks for 50 and 400 waiting to be used.  
As I said, 144 and 1296 have been running for years.

I build the RF decks in metal "shoeboxes". I pipe the LO and IF(with tx  
switching as DC on the line) to each deck which lets me remote them  
if I want to. The only thing I really need to add that I haven't is an  
ALC line coming back from each PA to control the 735 so that I keep  
things linear. Linearity hasn't been a problem but like any of the  
current commercially available transverters it is possible to overdrive  
things.

Hope this helps.

73  
Glenn n6gn



Article: 17580 of rec.radio.shortwave  
Comments: Gated by NETNEWS@AUVM.AMERICAN.EDU  
Path: news.cs.tut.fi!butler.cc.tut.fi!fuug!mcsun!uunet!paladin.american.edu!  
auvm!S850.MWC.EDU!DWILSON  
Return-Path: <@OHSTVMA.ACS.OHIO-STATE.EDU:dwilson@s850.mwc.edu>  
Mailer: Elm [revision: 66.25]  
Message-ID: <SWL-L%93011916574454@OHSTVMA.ACS.OHIO-STATE.EDU>  
Newsgroups: rec.radio.shortwave  
Date: Tue, 19 Jan 1993 16:36:33 EST  
Reply-To: "David L. Wilson" <dwilson@S850.MWC.EDU>  
Sender: Short Wave Listener's List <SWL-L@OHSTVMA.BITNET>  
From: "David L. Wilson" <dwilson@S850.MWC.EDU>  
Subject: R-71A Memory Notes  
Lines: 25

I have heard that a new company named Willco is going to sell no fail memory for the Icom radios.

Two models, one with 64 channels for around \$70 and a 1000 memory channels for around \$149 will replace the small battery backup unit. The Willco board will use standard AA batteries. When the batteries die in the Willco unit, the radio won't fail and need servicing as is now the case. (However, the memories would need to be re-programmed.)

Using the lock button and memory switch, one steps through the banks of 32 channels each. One channel in each bank can be used to store the channel number for display to identify the bank number according to the maker.

Willco's address is P.O. box 788 NewLenox Il. 60451

If someone orders one, let me know what you think of it. I am not sure which radios other than the R-71A in which it will work.

--

|                           |                                           |
|---------------------------|-------------------------------------------|
| David L. Wilson           | dwilson@s850.mwc.edu                      |
| Department of Mathematics | Phone: H (703)898-1084 W (703)899-4744    |
| Mary Washington College   | Amateur callsign: AC4IU (ex-KD4ASW/KO4EQ) |
| Fredericksburg, VA 22401  | Lat./Long.: 38 15 40 N/ 77 32 51 W        |



From: wa2ise@cbnewsb.cb.att.com (robert.f.casey)  
Newsgroups: rec.radio.amateur.misc  
Subject: ICxx71 ram adaptor for use with eprom programmer  
Keywords: mod  
Message-ID: <1991Nov3.211340.28400@cbfsb.att.com>  
Date: 3 Nov 91 21:13:40 GMT  
Sender: news@cbfsb.att.com  
Organization: AT&T Bell Laboratories  
Lines: 41

copied from packet:

```
Msg# TSF Size #Rd Date Time From MsgID To
63934 BN 2638 0 24-Oct 0027 DG8FZ 91A211DG8FZ ICOM@WW (NONE)
Sb: IC-xx71-ram-adapter (1. update)
```

de DG8FZ @ DB0SIF

how to read/programm the ICOM-battery-RAM by EPROMER:

```
Adapter ICOM-RAM <==> 2764-Programmer socket
12.dez.89 .....
. R 5V 20.----- 28 +5V the factory programs
Q4-7 16-19 -+ . A CS 19.---(*) the lower 255 Nibbels...
0V 14 -----+ 1 E M AD 9 18.----- 24 A 9
.2 AD 8 17.----- 25 A 8 you find the frequency-
+5V 28 --o..o- 3 WP U AD 7 16.----- 3 A 7 range reading the 'hexdump'
Q3 15 -----4 D3 N AD 6 15.----- 4 A 6 backwards.
Q2 13 -----5 D2 I AD 5 14.----- 5 A 5
Q1 12 -----6 D1 T AD 4 13.----- 6 A 4 my tnx to dl8scu @ db0aaa,
Q0 11 -----7 D0 AD 3 12.----- 7 A 3 df8wu @ db0lj ,
Prog 27 -----8 WR' AD 2 11.----- 8 A 2 dc4fe &
testet with: . AD 1 10.----- 9 A 1 dl8zaw @ db0sif
IC-751 , 271h, . upside AD 0 9.----- 10 A 0
471e,1271a. ....
```

```
CE--20-inv.--
OE--22- nand--(*) use a 4011 for the nand's and the inverter.
nand-- dont forget to set the unused 4011 inputs high.
PGM-27-
```

if your eprommer cancels operation with a 'no eprom inside'-error  
contact each eprommer-pin to a normal 2764 but  
dont connect the pins 11,12,13,15,27 of the normal eprom,  
dont connect the pins 16-19 to 0V as shown above,  
program the 2764 to all bytes = low before.

73's de Karl (dg8fz @ db0sao.deu.eu) 12.Dez.89, 21.Okt.91

---

Note: I haven't tried or verified this, proceed at your own risk. Please  
direct questions to DG8FZ@db0sao.deu.eu on packet. WA2ISE







## Cross Band Repeat Function

To access the cross-band repeat function, first perform the extended receive mod by holding down the Light/B/# keys while turning on the power.

To enable cross-band repeat, set each band to the frequency and mode desired. Set the current band to VHF.

Press (Function-2) (Function-Enter) and the little "L" indicator will flash. The radio is now in the cross-band repeat mode. To disable, press (Function-Enter) again.

## Extended Transmit Mod

Call the ICOM parts department ((206) 454-8155) and order a pair of MA133 diodes (P/N 1790000850). These are the three terminal surface mount diode packages. It is probably not advisable to substitute conventional leaded glass diodes here due to size restraints.

The modification involves removing one surface mount component and installing two others. The working parts are extremely small and the mod should not be performed unless you are comfortable with working while using a loop eyepiece or other magnifying device. This is a "surgical" operation. Take all the usual precautions with respect to static electricity, etc.

Remove 5 screws holding back on, and two screws on side of case below the PTT switch. Gently pry the unit apart.

Inside the unit are two RF "stack" units. The complete RF "stack" is composed of two enclosed sheet metal boxes sandwiched together, about 1.5" wide, 2" tall and .5" thick. Each RF stack unit (one per band) is totally self contained, is about .25" thick, and plugs into the "motherboard" using connectors mounted on one end.

First, remove the stack units. To do this, remove one screw from each side of the stack. Remove the single screw off the bottom end of the stack and gently remove the metal spring clip holding the stack together.

Carefully lift each stack unit out by pulling it back and down. They should easily unplug from the upper motherboard. Set them aside for now.

At this time the back side of the front panel is clearly accessible and the two CPU's are visible side-by-side across the top. Now refer to the following illustration:

Top of Radio, Back side of Front Panel

---

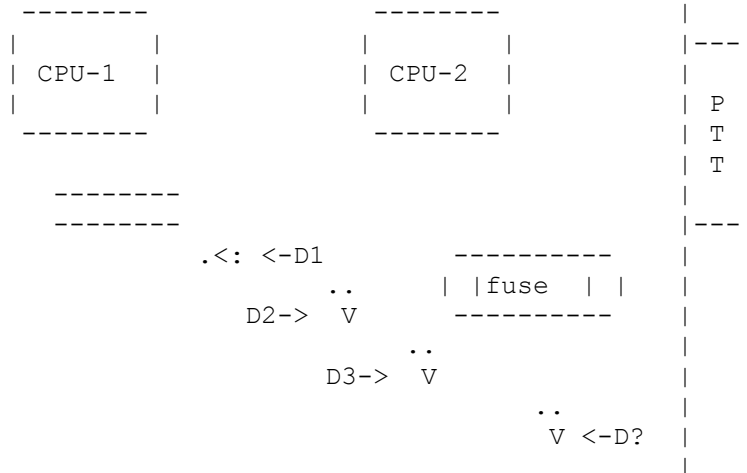

D1, D2 and D3 are locations on the board. Only D2 is installed at the factory. To perform the mod, you must do the following:

- Remove D2
- Install D1
- Install D3

The locations of D1 and D3 are clearly silk screened onto the circuit board and are easy to locate. Don't attempt to re-use D2. The periods (..) show the approximate location of the solder pads for the 2-legged sides of the diodes.

Diode D2 may be removed by carefully heating the leads and prying it up using a sharp tool. Be very careful since it's easy to lift the solder pads.

One method of installing diodes D1 and D3 is to use a very small drop of super glue to mount the part, and then use a soldering iron to tack down the pins.

After the parts are installed, reassemble the radio. Although the manufacturer recommends that the microprocessor be reset after this mod, I have found it to be unnecessary. All memories retained their settings after the mod. Tests using a dummy load and a frequency counter showed TX ability on UHF from under 400MHz to over 490MHz. TX on VHF covers from 136MHz to 174MHz.

-fred AA7BQ

--

| Fred Lloyd AA7BQ Fred.Lloyd@West.sun.com |  
 | Sun Microsystems, Inc. ...sun!flloyd |  
 | Phoenix, AZ (reality -- what a concept!) (602) 275-4242 |

---

Now for the added part - multi-digit entry for mhz

After doing the above, REQUIRED!!

select the VHF band as MAIN

push F (above the PTT button) and SET (the 8 button)

then using the ^/SCAN button make the lower right symbol of the band say PL

rotate the right knob to set the display to 1,10, or 100 as desired

|     |                                      |
|-----|--------------------------------------|
| 1   | sets entry to single digits only     |
| 10  | sets entry to 10's and single digits |
| 100 | sets entry to all digits             |

hit PTT

Now - repeat the above for the UHF band - Note It WILL NOT work unless you do it for BOTH bands.

You now have a walkie that requires all the digits (assuming you chose 100) to program it's frequencies.

/s/ Bob Gettys N1BRM

---

Rupert,

Here is more info on the the performance of the W2A after the mod.

John. N0LHW

Well folks I have had my IC-W2A for one week now & am, needless to say suitably impressed. But now my comments...

Why did Icom have to change the DC input socket to what the W2A has. It is very unusual & as far as I can find out, Icom are the only people who can supply a plug for it. I think they should have stayed with the more common 2.1mm DC jack as per the IC-32AT.

I did some checks of the receivers using an IFR 500A signal generator & the following is what signal level I needed to get 1 "S" point on the W2A's S meters.

|                     |                  |                                        |
|---------------------|------------------|----------------------------------------|
| At 70mhz,           | 1mV              | (milli-volts)                          |
| 80mhz               | 0.5mV            |                                        |
| 90mhz               | 0.25mV           |                                        |
| 100mhz              | 75uV             | (micro-volts)                          |
| 110mhz              | 1.5uV            |                                        |
| From here to 170mhz | less than 0.2uV  |                                        |
| 173mhz              | 1.5uV            |                                        |
| 174mhz              | 75uV             |                                        |
| 200mhz              | 75uV             |                                        |
| 250mhz              | 0.5mV            | (whats going on here???)               |
| 275mhz              | 4uV              |                                        |
| 300mhz              | 1.5uV            |                                        |
| 320mhz              | 5uV              | (changed to UHF main VFO from here on) |
| 400 - 450mhz        | less than 0.35uV |                                        |
| 460mhz              | 0.75uV           |                                        |

465 - 510mhz less than 1uV  
520 - 690mhz less than 2uV  
700 - 999mhz varies from 7.5uV to 2uV, dips to 0.35uV at 900mhz.

Quite impressive, but I would really like to get better sensitivity at the 70 - 80mhz end. Studying the circuit diagram shows bandpass/bandstop filters all over the show, so maybe its possible to modify a few to increase sensitivity here.

I am gathering together the ciruits of the Icom IC-R1, IC-24AT & W2A to compare the front ends so we will see what comes of this experiment in the near future.

One other worry was the on/off switch, how do you turn the set off when the battery is flat. I am concerned about running the battery to zero volts, hopefully this does not occur. I have been disconnecting the battery when charging to prevent anything funny happening.

The antenna supplied with my W2A is an FA-1443BB, whats the difference between this & the FA-1443B, & the FA-4B supplied with an IC-R1.

One more gripe, I dont like the plastic plug/covers over the DC jack, headphone, external speaker sockets, they should have been rubber as per the IC-32AT, as I can see already that they will not last very long after prolonged use. Boy what a moaner, you say, small complaints but this would really have made it the best. I wonder what Yaesu & Kenwood are going to do to compete with this???

Cheers

C. Tetenburg (ZL1BQJ)  
Network Controller  
Ministry of Forestry Computer Centre  
Forest Research Institute  
Sala St.  
Rotorua  
New Zealand

Internet: charlie@mof.govt.nz

>From daemon Mon Jul 15 23:39:24 1991  
Received: by violet.berkeley.edu (5.61/1.32)  
id AA03693; Mon, 15 Jul 91 14:39:02 PDT  
Date: Mon, 15 Jul 91 14:39:02 PDT  
From: admitq@violet.berkeley.edu (Graduate Division-Admissions)  
Message-Id: <9107152139.AA03693@violet.berkeley.edu>  
To: info-admin@infoac.rmi.de  
#Subject: Re: Request: rig; Topic: icom\_ic\_w2  
Status: OR

Thanks For The IC W2A Mods.

The extended receive that HRO Oakland gave me differs slightly from the posted version...my display (sensitivity is another matter) indicated RX from DC to somewhere just below IR after:  
turn off  
simultaneously press-funct-3-B-# keys  
turn on

(end of mod)

It has been pointed out that only the funct is different from

previously posted version, but I wonder. I get the feeling that there are many more hidden tricks to this rig that only ICOM knows about. I'd really be curious about any kind of data transfer/cloning capabilities it may have, etc.

-73 de Michael Dahl

KC6UFR

e-mail: admitq@violet.berkeley.edu

A couple of weeks ago I posted an inquiry about bad transmit audio in a IC-W2 handheld. I would like to thank everybody who sent in their response.

Some said their radios work well, one said his doesn't and one told Icom America had repaired similar symptoms in his friend's radio. A later comparison with a healthy unit confirmed that the fault wasn't between the operator's ears...:-)

However, Jukka, OH2BUA, a good friend of mine happened to work me with his brand new IC-2SRE. He had audio characteristics astonishingly similar to my radio. As a result to my complaints he opened his radio and cured the problem. Last Monday I did the same job and here it comes:

----- W A R N I N G -----

Servicing your radio by yourself may void the warranty. The author takes no responsibility whatsoever of the possible hassles with warranty codes intended for technically non-experienced radio users.

If you are not a qualified radio service technician or if you are not accustomed to work with extremely miniature surface-mount components, return your radio to the dealer with the following instructions.

----- W A R N I N G -----

Radio: IC-W2A/E, IC-2SRA/E, IC-4SRA/E

Trouble: Weak transmit audio, deviation below the specifications, high end of the speech spectrum missing.

Tools needed: A good soldering iron with a sharp tip, desoldering braid, solder, sharp-nosed pliers, small cross-point screwdrivers.

Cure:

1. Open the radio case following the instructions in the owner's manual (p. 45).
2. In radios fitted with the UT-63 board, pull out the board.
3. Unscrew the two small screws holding the tin plate against the bottom ends of the band modules. Pull out the plate.
4. Pull out the band modules.
5. Now you see the microphone fitted to the mother board. It should fit neatly against the inside of the fascia panel. If it doesn't, carry on.

6. Unsolder the microphone leads from the mother board. BE CAREFUL not to overheat the board and the wire insulation.
7. Pull out the microphone and the rubber gasket.
8. Re-install the gasket. Pull in the microphone so that it fits inside the gasket well and press it firmly to the end.
9. Re-solder the mic wires.
10. Install the band modules, the tin plate and don't forget the screws.
11. Replace the rear panel.
12. Tighten the 7 screws.
13. Test the audio response.

(c) OH2BUA and OH3BK, 1991. Unlimited reproduction allowed.

--

Richard Crisp  
MIPS Computer Systems  
928 Arques MS 5-07  
Sunnyvale, Ca 94086

crisp@mips.com  
!decwrl!mips!crisp  
(408) 524-7250





Newsgroups: rec.radio.amateur.misc  
From: bryan@edgar.mn.org (Bryan Halvorson)  
Subject: Re: W2A receiver modification  
Message-ID: <1993May02.043741.25872@edgar.mn.org>  
Reply-To: bryan@edgar.mn.org  
Organization: Electronics 101. Apple Valley MN  
References: <C6D39G.2Ln@news.iastate.edu> <1993May1.155436.1@vaxc.stevens-  
tech.edu>  
Date: Sun, 02 May 1993 04:37:41 GMT  
Lines: 54

In article <1993May1.155436.1@vaxc.stevens-tech.edu> u95\_dgold@vaxc.stevens-  
tech.edu writes:

> I've heard of a mod to increase the UHF out of band receive sensitivity of  
the  
> W2A. Could anyone please send me or post more information about this.

I've got a diagram that shows how to do it but it's not real good at  
labeling pin numbers so I'll try to describe it.

One word of warning. The parts involved here are surface mount and are  
very tiny. It's very easy to screw something up and loose UHF receive.

You need to open up the the UHF unit inside the radio and look at the  
component side of the board.

Q7 is a 5 pin surface mount IC that is near the edge of the board, about  
a half an inch from the URF unit. There are 2 pins on the side nearest  
the URF unit. You must lift the one nearest the edge of the board. Most  
of the people that I know who've tried this have broken off the IC leg  
or lifted the pad from the circuit board.

I don't see Q7 in the schematic, I think it's D7 in there.

Q3 is a surface mount transistor thats near the center of the board  
about three quarters of an inch from the URF unit.

Once you've lifted the pin on Q7 you attach the cathode end of a 1N34  
diode to it. The anode end of the diode goes to the pin on Q3 that only  
has one pin on that side.

It sounds easy but Q7 is in a very tight corner. Here's an attempt at  
diagramming the locations. The "<-" mark where the connections should  
be.

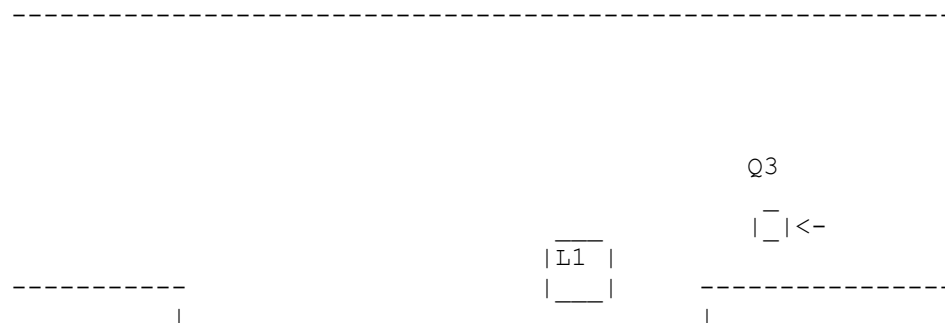

|       |  |       |       |          |
|-------|--|-------|-------|----------|
| VCO   |  | Q7    |       |          |
| UNIT  |  |       |       | URF unit |
|       |  | —     |       |          |
|       |  |       |       |          |
|       |  |       |       |          |
| ----- |  | _  <- | ----- |          |
| ----- |  |       |       |          |

--  
 Bryan Halvorson  
 NOBUU

bryan@edgar.mn.org  
 bryan@n0buu.tcman.ampr.org



From riku@juha.fi Fri Jul 2 05:43:39 1993  
To: Fred.Lloyd@West  
Subject: Updated version of IC-W2 extended xmit mod  
From: Riku Kalinen <Riku.Kalinen@juha.fi>  
Content-Length: 4992

I finally updated my copy of those mod instructions. Here it is.  
If You like to distribute this, please do so.

--

Extended Transmit Mod

Call the ICOM parts department ((206) 454-8155) and order a pair of MA133 diodes (P/N 1790000860). These are the three terminal surface mount diode packages (possibly SOT-22). It is probably not advisable to substitute conventional leaded glass diodes here due to size restraints.

The diodes are connected as follows:

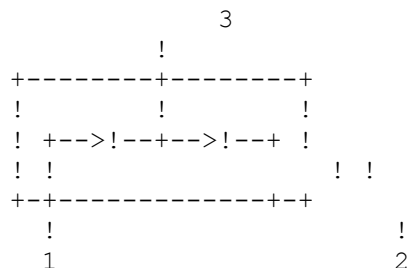

The modification involves removing one surface mount component and installing two others. The working parts are extremely small and the mod should not be performed unless you are comfortable with working while using a loop eyepiece or other magnifying device. This is a "surgical" operation. Take all the usual precautions with respect to static electricity, etc.

Remove 5 screws holding back on, and two screws on side of case below the PTT switch. Gently pry the unit apart.

Inside the unit are two RF "stack" units. The complete RF "stack" is composed of two enclosed sheet metal boxes sandwiched together, about 1.5" wide, 2" tall and .5" thick. Each RF stack unit (one per band) is totally self contained, is about .25" thick, and plugs into the "motherboard" using connectors mounted on one end.

First, remove the stack units. To do this, remove one screw from each side of the stack. Remove the single screw off the bottom end of the stack and gently remove the metal spring clip holding the stack together.

Carefully lift each stack unit out by pulling it back and down. They should easily unplug from the upper motherboard. Set them aside for now.

At this time the back side of the front panel is clearly accessible and the two CPU's are visible side-by-side across the top. Now refer to



- D20 connects D1 and 11.

These connections are totally undocumented by service manual.

Note that D19 and D20 are two-diode devices but it is actually possible to make the modification using two single diodes by connecting them between pins 1 and 2 in the place of SMD diode-pair. The space available is small, so consider this possibility only when You cannot get the SMD devices.

--

-- Riku "the bit" Kalinen, Suomen Tietoverkkopalvelu Oy

-- Ham: OH2LWO (>= 50MHz)

-- X.400: G=Riku;S=Kalinen;O=juha;P=juha;A=mailnet;C=fi

-- "Welcome to the party, pal!" -- Bruce Willis in "Die Hard"



MSG # TR SIZE TO FROM @BBS DATE TITLE  
Subject: KAM hf carrier detect mod.  
Forwarding path: KB3X VE3SNP VE3NUU VE3FJB VE3JF VE3IWJ

I noticed that the KAM, when connected or trying to connect, will start to transmit on top of an other signal at times. This will happen when a received signal appears just before the the KAM wants to transmit. It is visible by looking at the mark/space display. After a quiet period a received signal will light up the bargraph display and the KAM will transmit on top of it.

Looking at the circuit diagram, I noticed a 1 uF capacitor (c 29) in the carrier detect circuit. It seems to slow down the detect function more than desired. Changing the capacitor to .1 uF made the carrier detect work more the way I expect it to. It is easy to get at. Somewhere in the middle of the board. There is a layout in the manual. I didn't ask Kantronics about it. And I didn't notice any side effects. I also didn't try it in any of the other modes.

Comment to ve3iwj @ ve3iwj. 73 Nand.

Via WA8BXN BBS & WD8SCH - 02/17/89

Cleveland HAMNET File: KAMMOD.TXT





copied from packet:

Msg# TSF Size #Rd Date Time From MsgID To  
38132 BF 4720 0 13-Mar 1600 4X4CV 59967\_4X1RU MOD@WW ()  
Subject: KENWOD MIC MODIFICATION.

The following concerns modificatio of some Kenwood Microphone.

Note: What follows is just suggested, proceed at your own risk.

If you have a Kenwood TM-xxxE (European version) trans', Than your mic, probably has 1750 Hz baton, Which is useless in some countries (not if you are a jammer Hi). This baton can Probably be transformed to have another transceiver function.

I myself, tested the above & succeeded with both: TM-241E & TM-741E (of which the mic's slightly differ).

GENERALLY (at least in the two above) the 1750 Hz baton provides aprox' 7.5v (when depressed), in order to generate the tone. While the other 3 control baton on the mic provide lower voltage levels (aprox' 1.5v & 3.5v if i remember correctly). The idea is simply to disconnect the 7.5v at the baton input & to connect the other voltage level (1.5v or 3.5, I forgot which). To do this follow the next modif' stages.

MODIFICATION STAGES:

1) Disconnect the 7.5 voltage level by cutting the only jumper on the print. (to be sure measure 7.5v relative to ground on it, on the 741E mic it is symbolized by J1)

| the TM-741E                |            | the TM-241E                |            |
|----------------------------|------------|----------------------------|------------|
| ZDDDDDDDDDDDDDDDDDDDDDDDD? |            | ZDDDDDDDDDDDDDDDDDDDDDDDD? |            |
| 3                          | ZDDDDDD? 3 | 3                          | ZDDDDDD? 3 |
| 3                          | 3 ptt 3 3  | 3                          | 3 ptt 3 3  |
| 3                          | 3switch3 3 | 3                          | 3switch3 3 |
| 3                          | @DDDDDDY 3 | 3                          | @DDDDDDY 3 |
| 3                          | DD 3       | 3                          | DD 3       |
| 3                          | J1 3       | 3                          | J3 3       |
| 3                          | 3          | 3                          | 3          |
| 3                          | 3          | 3                          | 3          |
| @DDDDDDDDDDDDDDDDDDDDDDDDY |            | @DDDDDDDDDDDDDDDDDDDDDDDDY |            |

2) Short the 2 connections on:

the TM-741E

the TM-241E

```

ZDDDDDDDDDDDDDDDDDDDDDDDDDDDDDDDD?
3  ZDDDD?                3
3  3  3                    3
3                               3
3  3  3  3  3  3  3  3  3
3  0  0  0  0  3
3  3  3  3  3  3  3
3  3  3  3  3  3  3
3                               3
3  1750  VFO  MR  PF  3
3                               3
3                               3
3Microphone T91-0398-XX3
@DDDDDDDDDDDDDDDDDDDDDDDDDDDDDDY

```

The new function becoms:

```

^
3
3
default:call
programable:PF4

```

```

ZDDDDDDDDDDDDDDDDDDDDDDDDDDDDDDDD?
3  ZDD?                    3
3  3  3                    3
3                               3
3  3  3  3  3  3  3  3  3
3  0  0  0  0  3
3  3  3  3  3  3  3
3  3  3  3  3  3  3
3                               3
3  1750  VFO  MR  PF  3
3                               3
3                               3
3Microphone T91-0398-X53
@DDDDDDDDDDDDDDDDDDDDDDDDDDDDDDY

```

```

^
3
3
call
----

```

```

ZDDDDDDDDDDDDDDDDDDDDDDDDDDDDDDDDDDDDDDDDDDDDDDDDDDDDDDDDDDDDDDDDDDDDDDDDDDDDDDDDDDDDDDDDDDDDDDDD?
3 :  [[221100      73 DE Ze'ev 4X4CV @4X1RU.ISR.MDLE  001122[[ : 3

```

---

Note: I haven't tried or verified this, proceed at your own risk. WA2ISE



From: dbm@cats.njit.edu (Dean McDermott - WB2CMN)  
Newsgroups: rec.radio.amateur.misc  
Subject: Re: Any info on Moto gear for 902mhz FM?  
Keywords: Motorola FM 900 902  
Message-ID: <1992Oct25.044908.24872@njitgw.njit.edu>  
Date: 25 Oct 92 04:49:08 GMT  
References: <1992Oct24.082655.7322@grian.cps.altadena.ca.us>  
Sender: news@njit.edu  
Distribution: usa  
Organization: New Jersey Institute of Technology, Newark, N.J.  
Lines: 25  
Nntp-Posting-Host: cats.njit.edu

Yes the Maxtrac will work on the 900 ham band. However the Spectra is much harder. I have one Maxtrac converted and while getting to work took quite some time the final mod is not that bad.

#### Conversion:

Start with a 900 Mhz Maxtrac. If it is conventional then fine, if not then order FVN4019A conventional firmware. You will also need to order two Murata filters (# DFC3R915PO25BTD) from a Murata Erie dist in your area. Locate two chip caps with a value of 1.1 pf.

Install firmware if not already conventional. Remove the two Murata filters in the front end and replace with the above so that the radio will pass 915 +- 12.5 freqs. Locate the VCO and using a LARGE solder iron heat the top cover and pry it off. Now looking into VCO you will see that the small board has components on left and right halves and they are a mirror of each other (the left and right). Looking in two corners you will see chips with chip diode directly under it. It is very very tight in this

Remove these two chip caps that are next to the chip diodes. Replace with the 1.1 pf caps \*\*\* NOTE: The value of these caps might vary -- you may have to put anything from 1.1 to 1.9 pf in -- DO NOT use too much solder when installing caps. It is very easy to damage the VCO!!!!

Now put everything back together. I have mine operating with a RX area of 920 to 921 and TX of 907 - 909. Programming of the radio will require Maxtrac conventional software and when the program tells you the frq you entered is out of band disregard it and continue.

I am working on Spectra but not sure if this radio will make it. Anyone that has info on the Spectra please contact me.

Dean  
dbm@cats.njit.edu

From: dbm@cats.njit.edu (Dean McDermott - WB2CMN)  
Newsgroups: rec.radio.amateur.misc  
#Subject: Re: Standard 800 Portable



.....

#### RX VCO Mod

Remove RX cap, Remove TX cap, Place TX cap in location of original RX cap. (Note- You may be able to leave orig RX cap in place and add a large amount of solder to right side of cap while metering Steering Line voltage. Add solder until S/L voltage is in the area of 7 volts when radio is on your highest receive ham freq).

#### TX VCO Mod

After removing TX cap place a 1.7 pf cap in it's place. If this value is not available you may place a high stability variable cap of .5 to 4 or 5 pf in this place. If a variable cap is used you may have to use metal tape to make a cover with a hole for the cap to fit. Use as little solder as possible on the TX side. You should have a S/L voltage of no less then 2 volts while transmitting on your lowest freq.





Subject: Motorola Micor Repeater Conversion

Questions regarding this should be directed to jreese@sugar.neosoft.com

There are associated diagrams mentioned in the text. If you are unable to figure out what's going on without the diagrams, mail me and I'll try to get the diagrams to you some way.

Jim Reese  
WD5IYT

#### Instructions for Conversion of Motorola VHF Micor to Repeater Service

This modification is not for the faint-hearted. Be sure you are very comfortable with the operation of the MICOR radio before you attempt this modification. A thorough understanding of the way the MICOR radio and control system works is absolutely essential for the success of this conversion.

#### Modification Notes

This modification was developed for radios having receiver RF/IF board series TLD8270A; audio/squelch models TLN4310A-2 thru TLN4310A-5; and exciter models TLD8261A, TLD8262A, TLD8261B, or TLD8262B. If your radio differs from these part numbers, all or part of this modification may be different from the descriptions. Use your judgement to alter these instructions as necessary.

Whenever "Molex Pin x" is mentioned, it refers to the Armadillo Standard connector. This is a small, 9 pin Molex connector which serves as the interface for all of the Armadillo radios. Use a Female connector on the radio end. The standard pinout of the connector is:

- 1 - Ground
- 2 - Receive Audio Output
- 3 - n/c
- 4 - Transmit Audio Input
- 5 - COS Output
- 6 - PTT Input
- 7 - n/c
- 8 - PL Decoder Output (Sense)
- 9 - PL Select Input

The COS output and PTT input are open-collector to ground signals. Pin 8 goes to +9.6 V when PL is decoded. Pin 9 is ground for PL, open for Carrier.

These modifications allow "PL and Squelch" operation. This means that when in PL, the normal squelch circuit still operates. This avoids long noise bursts upon unkeying.

If using an Advanced Computer Controls, S-Com or other commercial controller which requires an active high PL sense signal, the signal at pin 8 can be attached to the "PL Sense input" on the controller. It will drive this input directly. On the S-Com controller, the pull up resistor on the PL sense input must be removed for proper operation.

## List of Tables and Illustrations

There are several illustrations which are detailed below. Refer to them as needed when modifying or constructing pieces of this project.

Table 1: This is a complete hookup chart for the control head plug and interface board.

Figure 1: Schematic of control head plug, with simple diagram.

Figure 2: Board Layout of audio squelch board detailing added capacitors.

Figure 3: Schematic of interface board.

Figure 4: Rough layout of interface board.

## Useful Motorola Part Numbers

|               |                                                        |
|---------------|--------------------------------------------------------|
| 68-81008E40-D | Manual for VHF MICOR                                   |
| K1007A        | TX Channel Element for VHF MICOR                       |
| K1005A        | RX Channel Element for VHF MICOR                       |
| KLN-6210A     | PL Encode Reed                                         |
| TLN-8381A     | PL Decode Reed                                         |
| 01-84307A89   | Empty Control Head Plug less cable, complete with pins |
| 66-84690C01   | Contact Removal Tool for MICOR plugs                   |
| TKN-6458A     | Large Fuse Holder for Primary Power (40A)              |

## Step-By-Step Instructions for Modification

Step 1: Make sure that the radio operates properly BEFORE any modifications are done. If there are problems with the radio, they will be easier to fix before the mods are done.

Step 2: If you are satisfied with the operation of the radio, construct the control head plug per figure 1 and table 1. Use miniature pots and switches inside the control head plug. It is rather tight inside, so be careful to check that the connector will re-assemble before you drill it up. After you have constructed the connector, make the following connections inside the control head plug: Jump control head pins 3, 8, and 22 to +12 V. Jump pins 9, 11, and 17 to ground. Plug the newly constructed control head plug into the radio and verify proper operation with the new control arrangement. If there are problems here, troubleshoot them NOW. Do not wait until later, as you may be chasing more than one problem.

Step 3: There are some modifications required on the control board and the receiver audio/squelch board in order to make the radio full duplex and to make preparations for the interface board. Remove CR201 on the audio/squelch board. Then, jump the F1 channel element to ground as described in the Motorola manual. Next, jump pins 1 and 4 of the audio squelch board. On the later version audio squelch board, there is a place for a jumper (JU-202), on earlier units, just make the jump with wire wrap wire. Next, remove a jumper on the audio squelch board which goes from pin 3 of the PL decoder to IC-202 pin 8. This is near the pins which the PL board plugs into. Check for continuity from pin 3 of the PL decoder to pin 11 of the audio squelch board with an ohmmeter. If there is not continuity, add a jumper. The later boards

have a trace from pin 3 of PL to pin 11 of audio squelch, on earlier boards, pin 11 is unused, and you should jump from PL decoder 3 to audio squelch 11 with some wire wrap wire. Add 15pF capacitors between the following pins on the two chips on the audio squelch board. Figure 2 details the location of these caps. On IC-201, add a cap between pin 3 and 4, and between pin 3 and 5. On IC-202, add caps between 5 and 9, 5 and 13, and two caps between 5 and 15. This makes the board less susceptible to RF.

Step 4: Next, carefully remove the front casting from the chassis. This is done by removing the four screws top and bottom as well as two screws on the control head plug. This is kind of tricky, so be careful to remember how you got it apart so you can re-assemble it later. You will expose the antenna relay with its two associated coax cables running to the transmitter and receiver. Unplug the receive coax from the antenna relay.

Step 5: Procure a BNC chassis mount connector for a receive antenna jack. Mount this connector on the top side curved surface of the front casting on the side opposite from where the lock is located. Be very careful to locate this connector so that it does not hinder the operation of the latch mechanism. Attach the receive coax to this connector routing the cable through a hole which you will drill in the front of the radio chassis. The method will be obvious once you have examined the unit with the front casting removed.

Step 6: Construct the interface board using the schematic and board layout in the packet. Install this board on the three unused mounting tabs near the rear center of the radio. These tabs are above the control board. Wire the board up as described in table 1. At this point, the radio will be operating full duplex, and you should be able to put the radio in PL by flipping the switch on the control head plug to the PL position. Verify that you have +9.6 volts at the 9 pin molex connector PL SENSE pin when the correct PL code is being sent. Also verify correct receive audio gating and COS action.

#### Tune Up Instructions

Tune the transmitter and receiver per the Motorola manual. Follow the procedures exactly.

Adjust the power set for the desired power output. I recommend no more than 60 Watts for 110 Watt radios, 40 Watts for 60 Watt Radios, and 30 Watts for 45 Watt Radios.

That's it. you are now ready for major repeating action. Make sure that you have adequate forced air cooling on the PA at all times during operation. The Micor PA is not easy to fix, and when it blows, it blows big.

--

Jim Reese, WD5IYT | "Real Texans never refer to trouble  
jreese@sugar.neosoft.com | as deep doo-doo" --Molly Ivins

Questions regarding this conversion may be directed to  
jreese@sugar.neosoft.com

There are associated diagrams mentioned in the text. If you are interested in these diagrams, send me mail and I'll figure out how to best get them to you.

Jim Reese  
WD5IYT

## Instructions for Conversion of Motorola UHF Micor to Repeater Service

This modification is not for the faint-hearted. Be sure you are very comfortable with the operation of the MICOR radio before you attempt this modification. A thorough understanding of the way the MICOR radio and control system works is absolutely essential for the success of this conversion.

### Modification Notes

Whenever "Molex Pin x" is mentioned, it refers to the Armadillo Standard connector. This is a small, 9 pin Molex connector which serves as the interface for all of the Armadillo radios. Use a Female connector on the radio end. The standard pinout of the connector is:

- 1 - Ground
- 2 - Receive Audio Output
- 3 - n/c
- 4 - Transmit Audio Input
- 5 - COS Output
- 6 - PTT Input
- 7 - n/c
- 8 - PL Decoder Output (Sense)
- 9 - PL Select Input

The COS output and PTT input are open-collector to ground signals. Pin 8 goes to +9.6 V when PL is decoded. Pin 9 is ground for PL, open for Carrier.

These modifications allow "PL and Squelch" operation. This means that when in PL, the normal squelch circuit still operates. This avoids long noise bursts upon unkeying.

If using an Advanced Computer Controls controller, the signal at pin 8 is run to the "PL Sense input" on the controller. It will drive this input directly.

Order the crystal on the repeater RECEIVE frequency. You must specify HIGH SIDE INJECTION. If you do not order a high side crystal, the transmit offset will be 5 MHz above the receive frequency, instead of 5 MHz below. I recommend sending the channel element to the crystal manufacturer for temperature compensation. Use a KXN-1024 element for 5ppm accuracy, or use a KXN-1029 element for 2ppm accuracy. Disable the receiver AFC by jumping the appropriate pin of the channel element to ground.

### List of Tables and Illustrations

There are several illustrations which are detailed below. Refer to them as needed when modifying or constructing pieces of this project.

Table 1: This is a complete hookup chart for the control head plug and interface board.

- Figure 1: Schematic of control head plug, with simple diagram.
- Figure 2: Board Layout of audio squelch board detailing added capacitors.
- Figure 3: Detail of circulator unit showing location of major components.
- Figure 4: Schematic of circulator unit before modification.
- Figure 5: Schematic of circulator unit after modification.
- Figure 6: Schematic of interface board.
- Figure 7: Rough layout of interface board.

#### Useful Motorola Part Numbers

|               |                                                        |
|---------------|--------------------------------------------------------|
| 68-81015E70-H | Manual for UHF MICOR                                   |
| KXN-1024      | 5ppm Channel Element for UHF MICOR                     |
| KXN-1029      | 2ppm Channel Element for UHF MICOR                     |
| KLN-6210A     | PL Encode Reed                                         |
| TLN-8381A     | PL Decode Reed                                         |
| 01-84307A89   | Empty Control Head Plug less cable, complete with pins |
| 66-84690C01   | Contact Removal Tool for MICOR plugs                   |
| TKN-6458A     | Large Fuse Holder for Primary Power (40A)              |

#### Step-By-Step Instructions for Modification

Step 1: Make sure that the radio operates properly BEFORE any modifications are done. If there are problems with the radio, they will be easier to fix before the mods are done.

Step 2: If you are satisfied with the operation of the radio, construct the control head plug per figure 1 and table 1. Use miniature pots and switches inside the control head plug. It is rather tight inside, so be careful to check that the connector will re-assemble before you drill it up. After you have constructed the connector, make the following connections inside the radio: Jump control head pins 3, 8, and 22 to "A+" on the control board. Jump pins 9, 11, and 17 to ground on the control board. Next locate the two feedthrough caps which power the Transmitter Power Amplifier. They are just to the left of the control head plug on the bottom side of the radio. One will have a red wire, and the other a black wire. Jump from the feedthrough with the red wire to the "A+" trace on the control board. Jump from the feedthrough with the black wire to the ground trace on the control board. There is a reverse polarity protection diode on the control board which can be used to make these connections. Next, plug your control head plug into the radio and verify proper operation with the new control arrangement. If there are problems here, troubleshoot them NOW. Do not wait until later, as you may be chasing more than one problem.

Step 3: You must make some modifications to the control board and the receiver audio/squelch board in order to make the radio full duplex and to make preparations for the interface board. First, remove JU-905 on the control board. Then, jump the F1 channel element to ground as described in the Motorola manual. Next, jump pins 1 and 4 of the audio squelch board. On the later version audio squelch board, there is a place for a jumper (JU-202), on

earlier units, just make the jump with wire wrap wire. Next, remove a jumper on the audio squelch board which goes from pin 3 of the PL decoder to IC-202 pin 8. This is near the pins which the PL board plugs into. Next, ring from pin 3 of the PL decoder to pin 11 of the audio squelch board with an ohmmeter. There should be continuity here. If not, add a jumper. The later boards have a trace from pin 3 of PL to pin 11 of audio squelch, on earlier boards, pin 11 is unused, and you should jump from PL decoder 3 to audio squelch 11 with some wire wrap wire. Add 15pF capacitors between the following pins on the two chips on the audio squelch board. Figure 2 details the location of these caps. On IC-201, add a cap between pin 3 and 4, and between pin 3 and 5. On IC-202, add caps between 5 and 9, 5 and 13, and two caps between 5 and 15. This makes the board less susceptible to RF.

Step 4: Next, carefully remove the front casting from the chassis. This is done by removing the four screws top and bottom as well as two screws on the control head plug. This is kind of tricky, so be careful to remember how you got it apart so you can re-assemble it later. Next, examine the Power Amplifier section of the radio and notice the miniature connector which connects the output of the PA to the circulator. Unplug this connector from the circulator using a needle nose plier or hemostat. Next, turn over the radio and remove the power control board. This will expose the top plate of the circulator. Remove the circulator by carefully removing the sensing wires which connect to the power control board and the two screws which hold the circulator in. You will have to unplug the receive antenna coax from the preselector unit in order to remove the circulator. Set the circulator aside for later modification.

Step 5: Procure a BNC chassis mount connector for a receive antenna jack. Mount this connector on the top side of the front casting on the side opposite from where the lock is located. Be very careful to locate this connector so that it does not hinder the operation of the latch mechanism. Attach a small coax to this connector and route it to the receive antenna jack on the preselector unit. Drill a hole in the front of the radio chassis to pass the coax. This will be obvious once you have examined the unit with the front casting removed.

Step 6: This is the toughest part of the conversion, the circulator modification. Figures 3, 4, and 5 detail the conversions. Remove the cover from the circulator unit. You will notice that there is a circulator, an output filter, the antenna switch, and the circulator reject load. There are three trimmer caps, only one of which has an access hole in the top plate. Measure and drill the top cover so that you have access to all three trimmers from the outside. This is necessary because the cover affects the tuning of the circulator. After drilling the cover, set it aside. You must now remove the antenna relay. This is a small relay on the right side of the circulator. The small dark red rectangular unit with a wire coming from the relay is the reject load for the circulator. The relay switches the output port of the circulator between the receiver and the reject load. You must remove the relay and wire the dummy load back to the output port of the circulator which is on the common side of the relay. Refer to the diagram for the circuit. The easiest way to accomplish this is with a small piece of teflon coax (RG-188). Run from the circulator port to the reject load. You can solder to the circulator case for the shield on the load end of the coax. Replace the cover on the circulator and reinstall it in the radio.

Step 7: Construct the interface board using the schematic and board layout in

the packet. Install this board on the three unused mounting tabs near the rear center of the radio. These tabs are above the control board. Wire the board up as described in table 1. At this point, the radio will be operating full duplex, and you should be able to put the radio in PL by flipping the switch on the control head plug to the PL position. Verify that you have +9.6 volts at the 9 pin molex connector PL SENSE pin when the correct PL code is being sent. Also verify correct receive audio gating and COS action.

### Tune Up Instructions

Tune the radio per the Motorola manual. Once you have achieved this, you need to tune the circulator. The following procedure should be followed:

Step 1: Remove the power control board, and power the radio with a supply having a current meter.

Step 2: Attach a jumper or clip lead from feedthrough C527 on the Controlled Stage in the PA compartment and feedthrough C536 on the driver stage in the PA compartment. This will force the radio to maximum power output.

Step 3: Key the transmitter and tune the three circulator capacitors for maximum power output.

Step 4: Reinstall the power control board, and preset the drive limit pot fully counter-clockwise. Set the power set pot to the desired power output level. I recommend no more than 50W out for a 75W radio, and no more than 60W out for a 100W radio. The 25 and 45W radios are rated continuous duty at 25W output.

Step 5: Key the transmitter and tune the center circulator capacitor (the only one accessible from the top of the power control board) for minimum current draw. You should be able to make several Amps difference without affecting the power output.

Step 6: Turn the drive limit pot 1/4 turn clockwise.

That's it. you are now ready for major repeating action. Remember to always set the receive frequency first when setting frequency, as this affects the transmitter also. Set the transmitter with the offset trimmer coil on the exciter board. Make sure that you have adequate forced air cooling on the PA at all times during operation. The Micor PA is not easy to fix, and when it blows, it blows big.

--

Jim Reese, WD5IYT | "Real Texans never refer to trouble  
jreese@sugar.neosoft.com | as deep doo-doo" --Molly Ivins

Why would you want a duplex mobile, you ask? Once you've experienced it, you'll never go back to jap-trac's.

This describes how to take a standard UHF micor mobile radio and make it work as a full-duplex mobile radio. Since Texas is high-in, low-out on UHF, this also includes which cap changes are required to make the radio receive

below 445 MHz.

There are diagrams referenced in this text. If you are unable to figure out what to do without the diagrams, mail me at jreese@sugar.neosoft.com and I'll try to get you a copy of the diagrams.

Jim Reese  
WD5IYT

### Conversion of Motorola MICOR UHF Radio For Use as a Duplex Mobile

This conversion is not for the faint-hearted. Make sure you are very familiar with the operation of the Micor radio before attempting this conversion. As with all modifications of this type, insure that the radio is operating correctly BEFORE any modifications are made. It is much easier to fix it before you hack it up. Do not attempt this conversion without a service manual. You need the PC layouts and tune up instructions from the service manual in order to perform the modification.

#### Useful Motorola Part Numbers

|               |                                           |
|---------------|-------------------------------------------|
| 68-81015E70-H | Manual for UHF MICOR                      |
| KXN-1024      | 5ppm Channel Element for UHF MICOR        |
| KXN-1029      | 2ppm Channel Element for UHF MICOR        |
| KLN-6210A     | PL Encode Reed                            |
| TLN-8381A     | PL Decode Reed                            |
| 66-84690C01   | Contact Removal Tool for MICOR plugs      |
| TKN-6458A     | Large Fuse Holder for Primary Power (40A) |

#### Crystal Ordering Information

When ordering crystals, specify the KXN-1024A channel element number. Always order the crystal on the RECEIVE frequency. If your radio will be a high transmit unit, the crystal will be LOW side injection. For low transmit radios, order the crystals on HIGH side injection. This will flip the transmit offset to the other direction.

#### Conversion Instructions

##### Step 1:

Make sure that the radio is operating properly by tuning it up with one of your crystals before any modifications are made. If you are using the radio as a high transmit unit, you must make the capacitor changes in step 2 for the radio to work properly.



#### Step 2:

If your radio will be receiving below 445 MHz, change C117 to 27pF, C119 to 39pF, and C125 to 12pF on the receiver board. This is not necessary if the radio will be receiving above 445 MHz.

#### Step 3:

You must make some modifications to the control board and the receiver audio/squelch board in order to make the radio full duplex. First, remove JU-905 on the control board. Next, jump pins 1 and 4 of the audio squelch board. On the later version audio squelch board, there is a place for a jumper (JU-202), on earlier units, just make the jump with wire wrap wire.

Add capacitors at the following points on the audio squelch board. Add a 100pF cap between P903-5 and P903-6. On IC-201, add 15pF caps between pins 3 and 4, and between pins 3 and 5. Add 100pF caps between pins 6, 7, 11, and 13 of IC-201 and ground. On IC-202, add 15pF caps between 5 and 9, 5 and 13, and a 33pF cap between 5 and 15. This makes the board less susceptible to RF. Keep the leads on these caps as short as possible.

#### Step 4:

Carefully remove the front casting from the chassis. This is done by removing the four screws top and bottom as well as two screws on the control head plug. This is kind of tricky, so be careful to remember how you got it apart so you can re-assemble it later.

Examine the Power Amplifier section of the radio and notice the miniature connector which connects the output of the PA to the circulator. Unplug this connector from the circulator using a needle nose plier or hemostat.

Turn over the radio and remove the power control board. This will expose the top plate of the circulator. Remove the circulator by carefully removing the sensing wires which connect to the power control board and the two screws which hold the circulator in. You will have to unplug the receive antenna coax from the preselector unit in order to remove the circulator. Set the circulator aside for later modification.

#### Step 5:

Mount a BNC chassis mount connector on the top side of the front casting on the side opposite from where the lock is located. This will be the receive antenna connection. Be very careful to locate this connector so that it does not hinder the operation of the latch mechanism. Attach a small coax to this connector and route it to the receive antenna jack on the preselector unit. Drill a hole in the front of the radio chassis to pass the coax. This will

be  
obvious once you have examined the unit with the front casting removed.

#### Step 6:

This is the toughest part of the conversion, the circulator modification. Remove the cover from the circulator unit. You will notice that there is a circulator, an output filter, the antenna switch, and the circulator reject load. There are three trimmer caps, only one of which has an access hole in the top plate. Measure and drill the top cover so that you have access to all three trimmers from the outside. This is necessary because the cover affects the tuning of the circulator. After drilling the cover, set it aside.

You must now remove the antenna relay. This is a small relay on the right side of the circulator. The small dark red or green rectangular unit with a wire coming from the relay is the reject load for the circulator. This is a ceramic 75W 50 Ohm resistor. The relay switches the output port of the circulator between the receiver and the reject load. Be EXTREMELY CAREFUL when soldering on the reject load, as the top terminal can break off of the ceramic very easily. I suggest cutting the wire from the relay, removing the relay, and then removing the wire from the load resistor. Once the relay is removed, wire the dummy load back to the output port of the circulator which is on the common side of the relay. Refer to the manual for the circuit. The easiest way to accomplish this is with a small piece of teflon coax (RG-188). Run from the circulator port to the reject load. You can solder to the circulator case for the shield on the load end of the coax. Replace the cover on the circulator and reinstall it in the radio.

#### Tuning Instructions

Before tuning, disable the receiver AFC by soldering a wire from the "AFC OFF" trace on the receiver board to ground. The procedure for disabling the AFC is described in the receiver tuning instructions section of the service manual.

Tune the radio per the Motorola manual. Once you have achieved this, you need to tune the circulator. The following procedure should be followed:

Remove the power control board, and power the radio with a supply having a current meter.

Attach a jumper or clip lead from feedthrough C527 on the Controlled Stage in the PA compartment and feedthrough C536 on the driver stage in the PA compartment. This will force the radio to maximum power output.

Key the transmitter and tune the three circulator capacitors for maximum power output.

Reinstall the power control board, and preset the drive limit pot fully counter-clockwise. Set the power set pot to the desired power output level.

Key the transmitter and tune the center circulator capacitor (the only one accessible from the top of the power control board) for minimum current draw. You should be able to make several Amps difference without affecting the power output.

Turn the drive limit pot 1/4 turn clockwise, or until power just starts to fall off.

That's it. Remember to always set the receive frequency first when setting frequency, as this affects the transmitter also. Set the transmitter with the offset trimmer coil on the exciter board. Make sure that you have adequate cooling space around the PA heat sink fins when the radio is installed.

The Micor PA is not easy to fix, and when it blows, it blows big.

--

Jim Reese, WD5IYT  
jreese@sugar.neosoft.com

| "Real Texans never refer to trouble  
| as deep doo-doo" --Molly Ivins



Newsgroups: rec.radio.amateur.misc  
From: jreese@NeoSoft.com (Jim Reese)  
Subject: Conversion of MICOR UHF to duplex mobile (long!)  
Organization: NeoSoft Communications Services -- (713) 684-5900  
Distribution: usa  
Date: Thu, 5 Nov 1992 22:15:16 GMT  
Message-ID: <Bx9KHJ.IDz@NeoSoft.com>  
Summary: how to make standard UHF micor mobile into duplex mobile  
Lines: 172

Why would you want a duplex mobile, you ask? Once you've experienced it, you'll never go back to jap-trac's.

This describes how to take a standard UHF micor mobile radio and make it work as a full-duplex mobile radio. Since Texas is high-in, low-out on UHF, this also includes which cap changes are required to make the radio receive below 445 MHz.

There are diagrams referenced in this text. If you are unable to figure out what to do without the diagrams, mail me at jreese@sugar.neosoft.com and I'll try to get you a copy of the diagrams.

Jim Reese  
WD5IYT

#### Conversion of Motorola MICOR UHF Radio For Use as a Duplex Mobile

This conversion is not for the faint-hearted. Make sure you are very familiar with the operation of the Micor radio before attempting this conversion. As with all modifications of this type, insure that the radio is operating correctly BEFORE any modifications are made. It is much easier to fix it before you hack it up. Do not attempt this conversion without a service manual. You need the PC layouts and tune up instructions from the service manual in order to perform the modification.

#### Useful Motorola Part Numbers

|               |                                           |
|---------------|-------------------------------------------|
| 68-81015E70-H | Manual for UHF MICOR                      |
| KXN-1024      | 5ppm Channel Element for UHF MICOR        |
| KXN-1029      | 2ppm Channel Element for UHF MICOR        |
| KLN-6210A     | PL Encode Reed                            |
| TLN-8381A     | PL Decode Reed                            |
| 66-84690C01   | Contact Removal Tool for MICOR plugs      |
| TKN-6458A     | Large Fuse Holder for Primary Power (40A) |

#### Crystal Ordering Information

When ordering crystals, specify the KXN-1024A channel element number. Always order the crystal on the RECEIVE frequency. If your radio will be a high

transmit unit, the crystal will be LOW side injection. For low transmit radios, order the crystals on HIGH side injection. This will flip the transmit offset to the other direction.

### Conversion Instructions

#### Step 1:

Make sure that the radio is operating properly by tuning it up with one of your crystals before any modifications are made. If you are using the radio as a high transmit unit, you must make the capacitor changes in step 2 for the radio to work properly.

#### Step 2:

If your radio will be receiving below 445 MHz, change C117 to 27pF, C119 to 39pF, and C125 to 12pF on the receiver board. This is not necessary if the radio will be receiving above 445 MHz.

#### Step 3:

You must make some modifications to the control board and the receiver audio/squelch board in order to make the radio full duplex. First, remove JU-905 on the control board. Next, jump pins 1 and 4 of the audio squelch board. On the later version audio squelch board, there is a place for a jumper (JU-202), on earlier units, just make the jump with wire wrap wire.

Add capacitors at the following points on the audio squelch board. Add a 100pF cap between P903-5 and P903-6. On IC-201, add 15pF caps between pins 3 and 4, and between pins 3 and 5. Add 100pF caps between pins 6, 7, 11, and 13 of IC-201 and ground. On IC-202, add 15pF caps between 5 and 9, 5 and 13, and a 33pF cap between 5 and 15. This makes the board less susceptible to RF. Keep the leads on these caps as short as possible.

#### Step 4:

Carefully remove the front casting from the chassis. This is done by removing the four screws top and bottom as well as two screws on the control head plug. This is kind of tricky, so be careful to remember how you got it apart so you can re-assemble it later.

Examine the Power Amplifier section of the radio and notice the miniature connector which connects the output of the PA to the circulator. Unplug this connector from the circulator using a needle nose plier or hemostat.

Turn over the radio and remove the power control board. This will expose the

top plate of the circulator. Remove the circulator by carefully removing the sensing wires which connect to the power control board and the two screws which hold the circulator in. You will have to unplug the receive antenna coax from the preselector unit in order to remove the circulator. Set the circulator aside for later modification.

#### Step 5:

Mount a BNC chassis mount connector on the top side of the front casting on the side opposite from where the lock is located. This will be the receive antenna connection. Be very careful to locate this connector so that it does not hinder the operation of the latch mechanism. Attach a small coax to this connector and route it to the receive antenna jack on the preselector unit. Drill a hole in the front of the radio chassis to pass the coax. This will be obvious once you have examined the unit with the front casting removed.

#### Step 6:

This is the toughest part of the conversion, the circulator modification. Remove the cover from the circulator unit. You will notice that there is a circulator, an output filter, the antenna switch, and the circulator reject load. There are three trimmer caps, only one of which has an access hole in the top plate. Measure and drill the top cover so that you have access to all three trimmers from the outside. This is necessary because the cover affects the tuning of the circulator. After drilling the cover, set it aside.

You must now remove the antenna relay. This is a small relay on the right side of the circulator. The small dark red or green rectangular unit with a wire coming from the relay is the reject load for the circulator. This is a ceramic 75W 50 Ohm resistor. The relay switches the output port of the circulator between the receiver and the reject load. Be EXTREMELY CAREFUL when soldering on the reject load, as the top terminal can break off of the ceramic very easily. I suggest cutting the wire from the relay, removing the relay, and then removing the wire from the load resistor. Once the relay is removed, wire the dummy load back to the output port of the circulator which is on the common side of the relay. Refer to the manual for the circuit. The easiest way to accomplish this is with a small piece of teflon coax (RG-188). Run from the circulator port to the reject load. You can solder to the circulator case for the shield on the load end of the coax. Replace the cover on the circulator and reinstall it in the radio.

#### Tuning Instructions

Before tuning, disable the receiver AFC by soldering a wire from the "AFC OFF" trace on the receiver board to ground. The procedure for disabling the AFC

is described in the receiver tuning instructions section of the service manual.

Tune the radio per the Motorola manual. Once you have achieved this, you need to tune the circulator. The following procedure should be followed:

Remove the power control board, and power the radio with a supply having a current meter.

Attach a jumper or clip lead from feedthrough C527 on the Controlled Stage in the PA compartment and feedthrough C536 on the driver stage in the PA compartment. This will force the radio to maximum power output.

Key the transmitter and tune the three circulator capacitors for maximum power output.

Reinstall the power control board, and preset the drive limit pot fully counter-clockwise. Set the power set pot to the desired power output level.

Key the transmitter and tune the center circulator capacitor (the only one accessible from the top of the power control board) for minimum current draw. You should be able to make several Amps difference without affecting the power output.

Turn the drive limit pot 1/4 turn clockwise, or until power just starts to fall off.

That's it. Remember to always set the receive frequency first when setting frequency, as this affects the transmitter also. Set the transmitter with the offset trimmer coil on the exciter board. Make sure that you have adequate cooling space around the PA heat sink fins when the radio is installed.

The Micor PA is not easy to fix, and when it blows, it blows big.

--

Jim Reese, WD5IYT  
jreese@sugar.neosoft.com

| "Real Texans never refer to trouble  
| as deep doo-doo" --Molly Ivins





Newsgroups: rec.radio.amateur.misc  
From: jreese@NeoSoft.com (Jim Reese)  
Subject: MICOR UHF mobile to repeater conversion instructions (long!)  
Organization: NeoSoft Communications Services -- (713) 684-5900  
Distribution: usa  
Date: Thu, 5 Nov 1992 22:03:34 GMT  
Message-ID: <Bx9Jy0.I12@NeoSoft.com>  
Summary: Step by step conversion of MICOR mobile radio to repeater (UHF)  
Lines: 220

Questions regarding this conversion may be directed to  
jreese@sugar.neosoft.com

There are associated diagrams mentioned in the text. If you are interested in these diagrams, send me mail and I'll figure out how to best get them to you.

Jim Reese  
WD5IYT

#### Instructions for Conversion of Motorola UHF Micor to Repeater Service

This modification is not for the faint-hearted. Be sure you are very comfortable with the operation of the MICOR radio before you attempt this modification. A thorough understanding of the way the MICOR radio and control system works is absolutely essential for the success of this conversion.

#### Modification Notes

Whenever "Molex Pin x" is mentioned, it refers to the Armadillo Standard connector. This is a small, 9 pin Molex connector which serves as the interface for all of the Armadillo radios. Use a Female connector on the radio end. The standard pinout of the connector is:

- 1 - Ground
- 2 - Receive Audio Output
- 3 - n/c
- 4 - Transmit Audio Input
- 5 - COS Output
- 6 - PTT Input
- 7 - n/c
- 8 - PL Decoder Output (Sense)
- 9 - PL Select Input

The COS output and PTT input are open-collector to ground signals. Pin 8 goes to +9.6 V when PL is decoded. Pin 9 is ground for PL, open for Carrier.

These modifications allow "PL and Squelch" operation. This means that when in PL, the normal squelch circuit still operates. This avoids long noise bursts upon unkeying.

If using an Advanced Computer Controls controller, the signal at pin 8 is run to the "PL Sense input" on the controller. It will drive this input directly.

Order the crystal on the repeater RECEIVE frequency. You must specify HIGH

SIDE INJECTION. If you do not order a high side crystal, the transmit offset will be 5 MHz above the receive frequency, instead of 5 MHz below. I recommend sending the channel element to the crystal manufacturer for temperature compensation. Use a KXN-1024 element for 5ppm accuracy, or use a KXN-1029 element for 2ppm accuracy. Disable the receiver AFC by jumping the appropriate pin of the channel element to ground.

#### List of Tables and Illustrations

There are several illustrations which are detailed below. Refer to them as needed when modifying or constructing pieces of this project.

Table 1: This is a complete hookup chart for the control head plug and interface board.

- Figure 1: Schematic of control head plug, with simple diagram.
- Figure 2: Board Layout of audio squelch board detailing added capacitors.
- Figure 3: Detail of circulator unit showing location of major components.
- Figure 4: Schematic of circulator unit before modification.
- Figure 5: Schematic of circulator unit after modification.
- Figure 6: Schematic of interface board.
- Figure 7: Rough layout of interface board.

#### Useful Motorola Part Numbers

|               |                                                        |
|---------------|--------------------------------------------------------|
| 68-81015E70-H | Manual for UHF MICOR                                   |
| KXN-1024      | 5ppm Channel Element for UHF MICOR                     |
| KXN-1029      | 2ppm Channel Element for UHF MICOR                     |
| KLN-6210A     | PL Encode Reed                                         |
| TLN-8381A     | PL Decode Reed                                         |
| 01-84307A89   | Empty Control Head Plug less cable, complete with pins |
| 66-84690C01   | Contact Removal Tool for MICOR plugs                   |
| TKN-6458A     | Large Fuse Holder for Primary Power (40A)              |

#### Step-By-Step Instructions for Modification

Step 1: Make sure that the radio operates properly BEFORE any modifications are done. If there are problems with the radio, they will be easier to fix before the mods are done.

Step 2: If you are satisfied with the operation of the radio, construct the control head plug per figure 1 and table 1. Use miniature pots and switches inside the control head plug. It is rather tight inside, so be careful to check that the connector will re-assemble before you drill it up. After you have constructed the connector, make the following connections inside the radio: Jump control head pins 3, 8, and 22 to "A+" on the control board. Jump pins 9, 11, and 17 to ground on the control board. Next locate the two feedthrough caps which power the Transmitter Power Amplifier. They are just to the left of the control head plug on the bottom side of the radio. One will have a red wire, and the other a black wire. Jump from the feedthrough with the red wire to the "A+" trace on the control board. Jump from the

feedthrough with the black wire to the ground trace on the control board. There is a reverse polarity protection diode on the control board which can be used to make these connections. Next, plug your control head plug into the radio and verify proper operation with the new control arrangement. If there are problems here, troubleshoot them NOW. Do not wait until later, as you may be chasing more than one problem.

Step 3: You must make some modifications to the control board and the receiver audio/squelch board in order to make the radio full duplex and to make preparations for the interface board. First, remove JU-905 on the control board. Then, jump the F1 channel element to ground as described in the Motorola manual. Next, jump pins 1 and 4 of the audio squelch board. On the later version audio squelch board, there is a place for a jumper (JU-202), on earlier units, just make the jump with wire wrap wire. Next, remove a jumper on the audio squelch board which goes from pin 3 of the PL decoder to IC-202 pin 8. This is near the pins which the PL board plugs into. Next, ring from pin 3 of the PL decoder to pin 11 of the audio squelch board with an ohmmeter. There should be continuity here. If not, add a jumper. The later boards have a trace from pin 3 of PL to pin 11 of audio squelch, on earlier boards, pin 11 is unused, and you should jump from PL decoder 3 to audio squelch 11 with some wire wrap wire. Add 15pF capacitors between the following pins on the two chips on the audio squelch board. Figure 2 details the location of these caps. On IC-201, add a cap between pin 3 and 4, and between pin 3 and 5. On IC-202, add caps between 5 and 9, 5 and 13, and two caps between 5 and 15. This makes the board less susceptible to RF.

Step 4: Next, carefully remove the front casting from the chassis. This is done by removing the four screws top and bottom as well as two screws on the control head plug. This is kind of tricky, so be careful to remember how you got it apart so you can re-assemble it later. Next, examine the Power Amplifier section of the radio and notice the miniature connector which connects the output of the PA to the circulator. Unplug this connector from the circulator using a needle nose plier or hemostat. Next, turn over the radio and remove the power control board. This will expose the top plate of the circulator. Remove the circulator by carefully removing the sensing wires which connect to the power control board and the two screws which hold the circulator in. You will have to unplug the receive antenna coax from the preselector unit in order to remove the circulator. Set the circulator aside for later modification.

Step 5: Procure a BNC chassis mount connector for a receive antenna jack. Mount this connector on the top side of the front casting on the side opposite from where the lock is located. Be very careful to locate this connector so that it does not hinder the operation of the latch mechanism. Attach a small coax to this connector and route it to the receive antenna jack on the preselector unit. Drill a hole in the front of the radio chassis to pass the coax. This will be obvious once you have examined the unit with the front casting removed.

Step 6: This is the toughest part of the conversion, the circulator modification. Figures 3, 4, and 5 detail the conversions. Remove the cover from the circulator unit. You will notice that there is a circulator, an output filter, the antenna switch, and the circulator reject load. There are three trimmer caps, only one of which has an access hole in the top plate. Measure and drill the top cover so that you have access to all three trimmers from the outside. This is necessary because the cover affects the tuning of the circulator. After drilling the cover, set it aside. You must now remove

the antenna relay. This is a small relay on the right side of the circulator. The small dark red rectangular unit with a wire coming from the relay is the reject load for the circulator. The relay switches the output port of the circulator between the receiver and the reject load. You must remove the relay and wire the dummy load back to the output port of the circulator which is on the common side of the relay. Refer to the diagram for the circuit. The easiest way to accomplish this is with a small piece of teflon coax (RG-188). Run from the circulator port to the reject load. You can solder to the circulator case for the shield on the load end of the coax. Replace the cover on the circulator and reinstall it in the radio.

Step 7: Construct the interface board using the schematic and board layout in the packet. Install this board on the three unused mounting tabs near the rear center of the radio. These tabs are above the control board. Wire the board up as described in table 1. At this point, the radio will be operating full duplex, and you should be able to put the radio in PL by flipping the switch on the control head plug to the PL position. Verify that you have +9.6 volts at the 9 pin molex connector PL SENSE pin when the correct PL code is being sent. Also verify correct receive audio gating and COS action.

#### Tune Up Instructions

Tune the radio per the Motorola manual. Once you have achieved this, you need to tune the circulator. The following procedure should be followed:

Step 1: Remove the power control board, and power the radio with a supply having a current meter.

Step 2: Attach a jumper or clip lead from feedthrough C527 on the Controlled Stage in the PA compartment and feedthrough C536 on the driver stage in the PA compartment. This will force the radio to maximum power output.

Step 3: Key the transmitter and tune the three circulator capacitors for maximum power output.

Step 4: Reinstall the power control board, and preset the drive limit pot fully counter-clockwise. Set the power set pot to the desired power output level. I recommend no more than 50W out for a 75W radio, and no more than 60W out for a 100W radio. The 25 and 45W radios are rated continuous duty at 25W output.

Step 5: Key the transmitter and tune the center circulator capacitor (the only one accessible from the top of the power control board) for minimum current draw. You should be able to make several Amps difference without affecting the power output.

Step 6: Turn the drive limit pot 1/4 turn clockwise.

That's it. you are now ready for major repeating action. Remember to always set the receive frequency first when setting frequency, as this affects the transmitter also. Set the transmitter with the offset trimmer coil on the exciter board. Make sure that you have adequate forced air cooling on the PA at all times during operation. The Micor PA is not easy to fix, and when it blows, it blows big.

--

Jim Reese, WD5IYT  
jreese@sugar.neosoft.com

| "Real Texans never refer to trouble  
| as deep doo-doo" --Molly Ivins



Newsgroups: rec.radio.amateur.misc  
From: jreese@NeoSoft.com (Jim Reese)  
Subject: MICOR VHF mobile to repeater conversion instructions (long!)  
Organization: NeoSoft Communications Services -- (713) 684-5900  
Distribution: usa  
Date: Thu, 5 Nov 1992 22:10:26 GMT  
Message-ID: <Bx9K9I.I8s@NeoSoft.com>  
Summary: step by step instructions to convert micor VHF mobile to repeater  
Lines: 163

Questions regarding this should be directed to jreese@sugar.neosoft.com

There are associated diagrams mentioned in the text. If you are unable to figure out what's going on without the diagrams, mail me and I'll try to get the diagrams to you some way.

Jim Reese  
WD5IYT

#### Instructions for Conversion of Motorola VHF Micor to Repeater Service

This modification is not for the faint-hearted. Be sure you are very comfortable with the operation of the MICOR radio before you attempt this modification. A thorough understanding of the way the MICOR radio and control system works is absolutely essential for the success of this conversion.

#### Modification Notes

This modification was developed for radios having receiver RF/IF board series TLD8270A; audio/squelch models TLN4310A-2 thru TLN4310A-5; and exciter models TLD8261A, TLD8262A, TLD8261B, or TLD8262B. If your radio differs from these part numbers, all or part of this modification may be different from the descriptions. Use your judgement to alter these instructions as necessary.

Whenever "Molex Pin x" is mentioned, it refers to the Armadillo Standard connector. This is a small, 9 pin Molex connector which serves as the interface for all of the Armadillo radios. Use a Female connector on the radio end. The standard pinout of the connector is:

- 1 - Ground
- 2 - Receive Audio Output
- 3 - n/c
- 4 - Transmit Audio Input
- 5 - COS Output
- 6 - PTT Input
- 7 - n/c
- 8 - PL Decoder Output (Sense)
- 9 - PL Select Input

The COS output and PTT input are open-collector to ground signals. Pin 8 goes to +9.6 V when PL is decoded. Pin 9 is ground for PL, open for Carrier.

These modifications allow "PL and Squelch" operation. This means that when in PL, the normal squelch circuit still operates. This avoids long noise bursts



upon unkeying.

If using an Advanced Computer Controls, S-Com or other commercial controller which requires an active high PL sense signal, the signal at pin 8 can be attached to the "PL Sense input" on the controller . It will drive this input directly. On the S-Com controller, the pull up resistor on the PL sense input must be removed for proper operation.

#### List of Tables and Illustrations

There are several illustrations which are detailed below. Refer to them as needed when modifying or constructing pieces of this project.

Table 1: This is a complete hookup chart for the control head plug and interface board.

Figure 1: Schematic of control head plug, with simple diagram.

Figure 2: Board Layout of audio squelch board detailing added capacitors.

Figure 3: Schematic of interface board.

Figure 4: Rough layout of interface board.

#### Useful Motorola Part Numbers

|               |                                                        |
|---------------|--------------------------------------------------------|
| 68-81008E40-D | Manual for VHF MICOR                                   |
| K1007A        | TX Channel Element for VHF MICOR                       |
| K1005A        | RX Channel Element for VHF MICOR                       |
| KLN-6210A     | PL Encode Reed                                         |
| TLN-8381A     | PL Decode Reed                                         |
| 01-84307A89   | Empty Control Head Plug less cable, complete with pins |
| 66-84690C01   | Contact Removal Tool for MICOR plugs                   |
| TKN-6458A     | Large Fuse Holder for Primary Power (40A)              |

#### Step-By-Step Instructions for Modification

Step 1: Make sure that the radio operates properly BEFORE any modifications are done. If there are problems with the radio, they will be easier to fix before the mods are done.

Step 2: If you are satisfied with the operation of the radio, construct the control head plug per figure 1 and table 1. Use miniature pots and switches inside the control head plug. It is rather tight inside, so be careful to check that the connector will re-assemble before you drill it up. After you have constructed the connector, make the following connections inside the control head plug: Jump control head pins 3, 8, and 22 to +12 V. Jump pins 9, 11, and 17 to ground. Plug the newly constructed control head plug into the radio and verify proper operation with the new control arrangement. If there are problems here, troubleshoot them NOW. Do not wait until later, as you may be chasing more than one problem.

Step 3: There are some modifications required on the control board and the receiver audio/squelch board in order to make the radio full duplex and to make preparations for the interface board. Remove CR201 on the audio/squelch

board. Then, jump the F1 channel element to ground as described in the Motorola manual. Next, jump pins 1 and 4 of the audio squelch board. On the later version audio squelch board, there is a place for a jumper (JU-202), on earlier units, just make the jump with wire wrap wire. Next, remove a jumper on the audio squelch board which goes from pin 3 of the PL decoder to IC-202 pin 8. This is near the pins which the PL board plugs into. Check for continuity from pin 3 of the PL decoder to pin 11 of the audio squelch board with an ohmmeter. If there is not continuity, add a jumper. The later boards have a trace from pin 3 of PL to pin 11 of audio squelch, on earlier boards, pin 11 is unused, and you should jump from PL decoder 3 to audio squelch 11 with some wire wrap wire. Add 15pF capacitors between the following pins on the two chips on the audio squelch board. Figure 2 details the location of these caps. On IC-201, add a cap between pin 3 and 4, and between pin 3 and 5. On IC-202, add caps between 5 and 9, 5 and 13, and two caps between 5 and 15. This makes the board less susceptible to RF.

Step 4: Next, carefully remove the front casting from the chassis. This is done by removing the four screws top and bottom as well as two screws on the control head plug. This is kind of tricky, so be careful to remember how you got it apart so you can re-assemble it later. You will expose the antenna relay with its two associated coax cables running to the transmitter and receiver. Unplug the receive coax from the antenna relay.

Step 5: Procure a BNC chassis mount connector for a receive antenna jack. Mount this connector on the top side curved surface of the front casting on the side opposite from where the lock is located. Be very careful to locate this connector so that it does not hinder the operation of the latch mechanism. Attach the receive coax to this connector routing the cable through a hole which you will drill in the front of the radio chassis. The method will be obvious once you have examined the unit with the front casting removed.

Step 6: Construct the interface board using the schematic and board layout in the packet. Install this board on the three unused mounting tabs near the rear center of the radio. These tabs are above the control board. Wire the board up as described in table 1. At this point, the radio will be operating full duplex, and you should be able to put the radio in PL by flipping the switch on the control head plug to the PL position. Verify that you have +9.6 volts at the 9 pin molex connector PL SENSE pin when the correct PL code is being sent. Also verify correct receive audio gating and COS action.

#### Tune Up Instructions

Tune the transmitter and receiver per the Motorola manual. Follow the procedures exactly.

Adjust the power set for the desired power output. I recommend no more than 60 Watts for 110 Watt radios, 40 Watts for 60 Watt Radios, and 30 Watts for 45 Watt Radios.

That's it. you are now ready for major repeating action. Make sure that you have adequate forced air cooling on the PA at all times during operation. The Micor PA is not easy to fix, and when it blows, it blows big.

--

Jim Reese, WD5IYT  
jreese@sugar.neosoft.com

| "Real Texans never refer to trouble  
| as deep doo-doo" --Molly Ivins



Date: Wed, 8 Feb 89 12:21:00 EST  
From: Mark Bramwell 519 661-3714 <julian!business.uwo.ca!  
MBramwel@uunet.UU.NET>  
Subject: mods database server  
To: Ham Radio List <info-hams@wsmr-simtel20.army.mil>

I have a small server program running here at the Business school.  
It accepts message as MAIL only. To retrieve a file, send a message to  
BITLIB@UWO.CA

The subject should be: MODS

The main body of the message could be as follows:

SENDME RADIO MODS  
SENDME TH215 MODS  
SENDME ALLBAND MODS

Please send any additions or changes to me: MBRAMWEL@uwo.ca  
or, VE3PZR@uwo.ca

If you have any, please send them along for others to enjoy.....

\*\* Since I do not personally own every piece of radio equipment  
available, I can not insure how accurate are the various mods.  
Questions with specific mods should be directed to the  
original poster.

Bitnet: MBRAMWEL@BUSINESS.UWO.CDN Packet: VE3PZR @ VE3GYQ



Article 18957 of rec.radio.amateur.misc:  
Path: west.West.Sun.COM!sun-barr!decwrl!csus.edu!netcomsv!teda!ardai  
From: ardai@teda.Teradyne.COM (Mike Ardai)  
Newsgroups: rec.radio.amateur.misc  
Subject: Re: Uniden MR8100  
Keywords: Uniden MR8100  
Message-ID: <43720@teda.Teradyne.COM>  
Date: 19 May 92 14:55:28 GMT  
References: <899@synopsys.COM>  
Organization: Teradyne EDA, Inc.  
Lines: 11

In article <899@synopsys.COM> georgez@synopsys.com (George Z) writes:  
-Does anyone know where I can get the secret code or mod  
-details for the Uniden MR8100 Scanner?

No mod details, but to enable the locked out frequencies, press <Alt>P  
and use the password 'ECPA1986'. (Interesting choice of a password :-)  
/mike

--

/ Michael L. Ardai N1IST Teradyne EDA

-----  
/| ardai@teda.teradyne.com





Subject: BRAVO pagers - undocumented test features

This information was copied from an article posted in rec.ham.radio in August 1991. This article may not answer many of the questions that were asked by the original poster, however, it may be useful to some of you on usenet. The author of this information is unknown. I saved this information because I have a BRAVO pager and found these tidbits of information useful.

~jack\_

.....Begin recorded message.....

IF YOU HAVE A MOTOROLA BRAVO PAGER THIS WILL HELP YOU WITH SOME OF THE FEATURES OF THIS UNIT YOU MY NOT KNOW ABOUT.

SELF TEST:

TO PUT UNIT INTO A SELF TEST TURN OFF PAGER. NOW HOLD DOWN THE GRAY ARROW KEY AND BLACK LOCK KEY AT THE SAME TIME AND TURN ON PAGER. THIS TELLS THE CPU IN PAGER TO GO INTO A SELF TEST. YOU WILL GET A 2 SECOND LONG BEEP, RELEASE THE GRAY & BLACK BUTTON AND PUSH THE GRAY BUTTON BEFORE THE 2 SECOND BEEP ENDS. IF YOU DID ALL THIS IN TIME YOU WILL HAVE "SPL" OR "PAGING P?" AND NOT THE DOTTED LINE YOU ARE USED TO SEEING WHEN YOU TURN ON PAGER . BY PRESSING THE GRAY KEY IT WILL GO TO A DISPLAY TEST, PRESS AGAIN AND YOU WILL GET THE PAGERS CAPCODE (CAPCODE IS THE UNIQUE SERIAL NUMBER WHICH THE PAGING TRANSMITTERS TRANSMITS TO YOUR PAGER TO TURN ON YOUR PAGER WHEN SOMEONE PAGES YOU). WAIT AND IN ABOUT 3 SECONDS IT WILL DISPLAY YOUR SECOND CAPCODE (IF YOU HAVE ONE-MOST DON'T) PRESS THE GRAY KEY AGAIN AND IT WILL CHECK CONTROLS, PRESS IT AGAIN AND IT WILL TEST VIBRATOR FUNCTION (IF YOUR PAGER HAS IT). TURN OFF PAGER AND TURN ON AGAIN TO DISABLE SELF TEST.

SPECIAL PROGRAMMED FEATURES:

TAKE OFF BATTERIES CLIP AND IN CENTER TOWARD THE FRONT OF PAGER YOU WILL SEE A PRINTED CIRCUIT BOARD EDGE PINS (JUST LIKE THE BACK SIDE OF A NETENDO CARTAGE. THIS EDGE PINS ARE PLUGGED INTO A CORE PROGRAMMER. THE PROGRAMMER CAN CHANGE.

CAPCODES: SEE ABOVE

AUTORESET TO MANUAL: YOUR PAGER IN AUTORESET WILL BEEP 8 TIMES THEN STOP BEEPING. MANUAL RESET THE BEEPER WILL KEEP BEEPING TILL THE COWS COME HOME OR YOU PUSH A BUTTON TO LOOK AT THE MESSAGE.

DISPLAY: ENGLISH PROMPTS OR INTERNATIONAL-SYMBOL SCREENS DISPLAYED.

SILENT MODE CHIRP: FOR A SINGLE BEEP WHEN YOUR PAGED. NOT FOR USE ON VIBRATOR PAGERS.

BEEP ON BAD DATA: YOUR PAGER HEARS IT'S CAPCODE BUT RECEIVED BAD DISPLAY MESSAGE, IT WILL PUT "EEE" ACROSS DISPLAY TO SHOW BAD RECEIVE. IF THIS IS FEATURE IS NOT ENABLED AND YOU RECEIVE BAD DATA YOUR PAGER WILL NOT BEEP AND YOU WILL HAVE NO IDEA SOMEONE TRYED TO

PAGE YOU.

\*\*\*\*\*  
NOW LETS SAY YOU ARE UNHAPPY WITH YOUR PAGING COMPANY "A" BUT OWN YOUR PAGER. YOUR \$200.00+ PAGER IS TUNED TO THEIR FREQUENCY AND YOU WANT TO GO TO ANOTHER PAGING COMPANY BUT NOT LOSE ALL THE MONEY YOU SPENT FOR YOUR PAGER. THE ANSWER IS TO RECRYSTAL PAGER TO THE NEW FREQUENCY OF COMPANY "B". BUT WE MUST ANSWER SOME QUESTIONS FIRST TO SEE WHAT IT WILL COST.

1. WHAT IS YOUR PAGERS CODING FORMAT (POCSAG) OR (GSC)  
THE EASY WAY TO TELL IS TO DO A SELF TEST AND READ CAPCODE. IF IT'S 7 NUMBERS IT'S POCSAG. IF IT'S 6 NUMBERS AND 1 LETTER IT'S GSC. IF YOUR PAGER DOES NOT MATCH THE SAME CODING FORMAT AS COMPANY "B" IT WILL COST MORE THEN IT'S WORTH TO CHANGE.

2. WHAT BAUD RATE IS YOUR PAGER WORKING AT ? DO SELF TEST AND IF DISPLAY SHOWS PAGING P1 PAGER IS WORKING AT 1200 BAUD OTHER WISE YOU ARE SAFE TO ASSUME 512 BAUD IT MUST MATCH COMPANY "B" BAUD RATE TO BE WORTH YOUR TIME.

3. ARE YOU IN THE SAME FREQUENCY BAND 931 MHZ OR 450 MHZ ETC. IF COMPANY "A" AND COMPANY "B" ARE NOT IN SAME BAND IT WILL TAKE A NEW RECEIVER BOARD TO CONVERT PAGER AND COST TO MUCH TO TRY.

IF ALL THE ANSWERS ABOVE SHOW YOU ARE COMPATIBLE YOU CAN CALL COMPANY "B" AND TELL THEM YOU WANT TO DO BUSINESS WITH THEM AND NEED A CAPCODE NUMBER SO YOU CAN GET PAGER RECRYSTALD AND HAVE A CAPCODE PROGRAMMED AT THE SAME TIME.

NOW YOU CAN HAVE COMPANY "B" RECOMMEND A SHOP THAT WILL RECRYSTAL PAGER OR LOOK UP ONE YOURSELF.

THE LEAST EXPENSIVE I HAVE FOUND IS:

ECONO-COMM  
3710 N.W. 16TH ST.  
LAUDERHILL, FLA. 33311

305-581-4980  
305-581-4985

LAST TIME I CHECKED RECRYSTAL OF PAGER COST \$19.00 AND REPAIR COST OF \$16.00 WITH A 30 DAY WARRANTY. BUT PRICES ARE ALWAYS CHANGING SO CALL FIRST BEFORE YOU SEND ANYTHING, AND MAKE SURE YOU INSURE PAGER IN SHIPPING.



From: G4UXD@GB7OAR  
Subject: PK-232 Lockup Cures

Dear Reader!

There was such a response to my note regarding "Cures for PK232 Lockup" that I've had to put out a general bulletin!

Here is a synopsis of some of the replies I got to my Help! cry:  
Lenny (the sysop @GB7LIV) reported that he ended up putting 0.01 uF disc ceramic capacitors between ALL connections to the radio (232 also? Derek) and ground. He also fitted a heavy braided earth strap from the chassis of the TNC to TRUE earth (onto the earth chassis of the computer or to an earth point on a 13 amp socket outlet). The problem then stopped TOTALLY.

Chris (G6FCI @ GB7FCI) reported a problem with his PK232 locking up when a fluorescent light (and other appliances sometimes) was turned to spikes getting onto the earths in the RS232 between the computer and TNC. He to solve it and is not quite sure which effected a cure.

1) Stick a decoupling cap between the RTS and CTS lines and earth (he thinks that was where he put them).

2) Strap the signal and frame ground lines together at the TNC and computer end of the RS232 cable. He knows that technically the two are supposed to be separate, but suspects that the problem arises when the signal ground ends up at a different potential from the frame ground. He hasn't had the TNC lock up for 6 months or more.

Alex (G1FBY @ GB7BMX) reported that he has had his 232 for two years. One of the first problems he encountered was lockup. All investigations of the unit proved OK. One Sunday his XYL was using the washing machine and dishwasher for long periods of time and the PK232 locked up 6 times. It was run on a fully regulated power supply. He fitted a Radio Spares spike protection socket to the mains plug of the power supply and all has been FB since.

\*\*\*\*\*

Hope this is useful,  
73 de Derek [G4UXD @ GB7OAR]



The PRO-2004 scanner can be used to receive cellular telephone conversations. Originally, the scanner was able to receive in this band, but at the last minute, it was decided to delete cellular coverage from the PRO-2004.

The procedure to re-instate the cellular band is simple for anyone with a pair of cutters, and a phillips screw-driver.

1. Remove the four screws from the back of the radio, and slide off the cover from the chassis.
2. Turn the radio upside down. You will find a metal box-like sub-chassis in the center of the main chassis. Remove the cover and you will be looking at the CPU, a 64-pin integrated circuit.
3. Examine the component side of this board, and you will find a row of diodes and resistors. On one end of the row you will find a diode labeled D-513.
4. Clip the accessible end of D-513, and pry apart the ends so they don't touch. You have just restored cellular coverage to you scanner.
5. If D-513 is not there, it may be located on the underside of the circuit board.

\*\*\* Information was extracted from POPULAR COMMUNICATIONS Aug 1987.

\*\*\* File appended: more mods for the scanner

From: ewb@raybed2.UUCP (EUGENE BALINSKI)  
Newsgroups: rec.ham-radio  
Subject: PRO-2004 MODS HERE THEY ARE !!!  
Keywords: AGAIN !  
Date: 12 Jan 89 14:34:39 GMT  
Organization: Raytheon Co., Bedford, Mass.

I guess it's time to post this article again. As always do these mods at your own risk. I assume no responsibility. 73 & good listening

Gene WA1UXA

These mods are detailed in the following articles:

- a) POPULAR COMMUNICATIONS AUG 87, PP 18-20
- b) MONITORING TIMES OCT 87, P 53
- c) MONITORING TIMES DEC 87, P 60

I suggest strongly that you obtain the back issues and read through the letters or articles. I also suggest you subscribe to the mags. They supply a lot of great info and freq lists. Now the mods.

- 1) Restoring 870 MHz coverage.

First treat the radio as if it were CMOS, that is make sure you and it have no built up static charges. UNPLUG THE RADIO FROM THE AC OR DC POWER SOURCE AND ANTENNA !!!!!!!!!!! Take the radio out of the case by removing the 4 screws on the back. Carefully invert the radio. Locate a box-like sub-circuit. It's near the switch marked "restart". The sub-circuit should be marked PC-3. Carefully pry off the cover of the metal box. Inside there will be a 64 pin dip

IC. This is the radio CPU. Be careful not to touch or short out any leads on the chip. Near the chip there will be a row of diodes marked D-502 to D-515. If D-513 is present, cut one lead, separate it so they will not touch, and magic, 870 Mhz is restored. If D-513 is not there and you still do not have 870 coverage, then a little more work is in order. Locate the 9 pin connector "CN-501". Carefully remove it from the sub-circuit. Unscrew the screws holding PC-3 to the main chassis. Carefully invert the sub-circuit board (PC-3). Locate the one lone component on that side of the board. If it is a diode, as it should be, then cut one lead and separate them as above. Re-install the sub-circuit with the screws on to the main chassis. Reconnect the 9 pin connector. Do NOT put the cover back on just yet ?!

#### 2&3) 400 CHANNEL and SPEED MOD !

On the top of the sub-circuit board, locate the slot for D-513. Count backwards from there until you get to the space for D-510. Install a diode at D-510 in the same polarity as the rest of the diodes. There, you now have 400 channels instead of 300 ! Now install a diode at D-514 and you have increased the scan speed to 20 channels/sec from 16 ch/sec. Carefully re-assemble the metal box. Make sure everything else is as it should be. RE-invert the radio so it is right side up.

#### 4) THE SQUELCH MOD !!

Now, locate a sub-circuit box under the sloping front panel. It should have many alignment holes in the top. Pry the cover off very carefully. Locate IC-2 in the left side of the pc board. It should be marked IC-10420. Locate R-148, a 47 K ohm resistor between pins 12 and 13. Cut a lead of this resistor, But be sure to leave enough lead on both sides of the cut to solder to. Patch in a 100K ohm resistor. Make sure there are no solder balls or short circuits. Now your squelch will operate more smoothly.

Again, I STRONGLY suggest you obtain the above mentioned magazines for more details. Addresses appear below. Please ignore any mis-spellings, mis grammer, etc. Good luck and good listening !!!

73

Gene WA1UXA

PS, make sure you re-install the metal cover and re-install the radio in the case !!!!!!!!!!!!!!!!!!!!!!!

Addresses: Popular Communications  
76 N Broadway  
Hicksville, NY. 11801

Monitoring Times  
140 Dog Branch Rd  
P.O. Box 98  
Brasstown, NC. 28902

Standard disclaimer applies !!!!!!!!!!!!!!!!!!!!!!!





Date: 30 Jan 90 10:22:00 GMT

From:

snorkelwacker!usc!cs.utexas.edu!jarvis.csri.toronto.edu!utgpu!attcan!  
darkover!n

ebulus!tmssoft!masnet!canremote!richard.dale@tut.cis.ohio-state.edu (RICHARD  
DALE)

Subject: 2004/2005 modifications

gr>Can someone please post the mods for the PRO-2004 & PRO-2005 for  
gr>continuous coverage through the 800 Mhz band, increased scan speed,  
gr>etc. I know someone who is interested in buying a PRO-2004/2005 and  
gr>would like more info on these mods.

Mon 01-29-1990 [07:38]

"Someone who is interested"??? Heh heh heh. Yeah, I don't listen to  
the CMT band, either. That ECPA has got me just petrified, hi. :-)  
I got these off a bulletin board.

+-----+  
| Modifications for the 2005 |  
+-----+

There is a socket that is not marked so it will be referred to as D501.

|                         |   |                                                            |
|-------------------------|---|------------------------------------------------------------|
| D501 and D503 removed   | : | Scan rate of 6/12 cps                                      |
| D501 only installed     | : | Scan rate of 7/14 cps                                      |
| *D503 only installed    | : | Scan rate of 8/16 cps                                      |
| D501 and D503 installed | : | Scan rate of 10/20 cps (horray!)                           |
| *D502 installed         | : | Disable 823.95-850.95 MHz and<br>868.95-895.95 MHz         |
| D502 removed            | : | Full coverage from 760-1300 MHz                            |
| D504 installed          | : | Normal spacing for all bands.                              |
| *D504 removed           | : | Enable 30 kHz spacing in areas<br>restored by D502 removal |

\* = Stock US model configuration

+-----+  
| Modifications for the 2004 |  
+-----+

1. Remove diode from "513" to get excluded 800 MHz freqs.
2. Install a 1N914 diode in "514" to increase scan rate to 10/20 channels-per-second.
3. Install a 1N914 diode in "510" to get the extra 100 channels.
4. Remove diode from "D-44" to restore missing frequencies in th 806 to 960MHz band.
5. Remove diode from "D-45" to restore coverage from 68 to 88MHz.

-----  
In step 5 above, I have no idea what this is for. My 2004 came  
from the store already scanning this range, and this was the first  
I had ever heard of it. The same goes for step 4. When I removed  
D513 (as in step 1), I got those freqs back. Perhaps the user who  
originally posted these had a radio from a different production  
run. All I can "vouch" for is steps 1, 2, and 3.

---

~ DeLuxe 1z11a20 #2989 pneumonoultramicroscopicasilicovolcanoconiosis  
~ QNet 2.03: NorthAmeriNet: Sound Advice BBS ~ Gladstone ~ MO

-----



Path: njitgw.njit.edu!dorm.rutgers.edu!rutgers!cs.utexas.edu!swrinde!  
zaphod.mps.ohio-state.edu!cis.ohio-state.edu!pacific.mps.ohio-state.edu!linac!  
att!ucbvax!ihlpm.UUCP!rats  
From: rats@ihlpm.UUCP  
Newsgroups: rec.radio.amateur.misc  
Subject: Re: PRO-2006  
Message-ID: <9111011425.AA29366@ucbvax.Berkeley.EDU>  
Date: 1 Nov 91 14:25:47 GMT  
Sender: daemon@ucbvax.BERKELEY.EDU  
Lines: 154

#### PRO-2006 Modifications

NOTE: The Electronic Communications Privacy Act of 1986 makes it unlawful to monitor mobile telephones, including cellular. The following modification is intended only to restore continuous 760-1300 MHz coverage as originally provided by the design of the PRO-2006 microprocessor.

BE SURE TO TEST YOUR PRO-2006 FULLY BEFORE ATTEMPTING THIS MODIFICATION. ANY MODIFICATION MAY VOID YOUR WARRENTY.

#### 824-851, 869-896 MHz Frequency Restoration

Tools Required: small Phillips screwdriver, small wire cutters.

Procedure: With the power cord unplugged, remove the two rear cabinet screws holding the upper cover. Lift off the upper cover, being careful not to stretch the speaker leads. Examine the inner, right-hand-corner of the front panel to find two glass diodes, labelled D503 (upper diode) and D502 (lower diode).

Using the clippers, very carefully snip the visible lead of the lower diode (D502) at its bend and slightly separate the cut ends. If it is ever necessary to send the radio back for warrenty repair, the diode leads should be carefully resoldered.

Reassemble, plug in AC cord, turn on scanner, and press RESET.

#### Keyboard Beep Delete

With the top cover removed as described above, locate connector CN3, a 15-pin connector with colored wires at the front of the main circuit board. There are two precedures which will stop the beep tone from being heard through the speaker; read both to decide which procedure you want to follow.

(1) Find the center grey wire coming from CN3 and cut it midway to disable the beep tone. You may wish to solder a resistor in series to reduce the beep volume, a trimpot to vary the volume of the beep tone, or a minature switch to choose between beep and no beep.

(or)

(2) Using a pair of needle-nose pliers, CAREFULLY pry the plug from CN3,

revealing a row of pins. Locate the center pin (#8) which corresponds to the grey wire and bend it down flat, disabling the beep circuit. Reinsert the plug. The pin may be erected again later to restore the beep tone if desired.

This completes the restoration procedure. Reattach the cover and replace the screws.

WARRANTY REPAIR

Should it be necessary during the first year of ownership of your new PRO-2006 to exercise your warranty, it should be carefully double-boxed (as you received it) and returned to Grove Enterprises. Be sure to include a copy of the original bill to establish warranty privileges.

You must prepay only shipping and insurance; return shipping and insurance to you will be paid by the dealer.

Grove Enterprises, P.O. Box 98, 140 Dogbranch Road  
Brasstown, NC; 1-704-837-9200

=====

=



From horak@convex.com Tue Jun 1 13:06:25 1993  
Newsgroups: alt.radio.scanner  
From: horak@convex.com (David Horak)  
Subject: Pro2005/6 SSB MOD HERE!  
Nntp-Posting-Host: eugene.convex.com  
Organization: CONVEX Computer Corporation, Richardson, Tx., USA  
Date: Mon, 31 May 1993 18:04:59 GMT  
X-Disclaimer: This message was written by a user at CONVEX Computer  
Corp. The opinions expressed are those of the user and  
not necessarily those of CONVEX.

I had a few requests for this mod so I thought everyone would benefit...

This is the mod for adding SSB capability to your Pro2005/2006. It is taken in part from Bill Cheek's Scanner Mod Handbook Volume 1. As long as you have a shortwave receiver with an external antenna jack and capability to tune to 455 KHz, you can interface it to the Pro2006 with this mod. It is best if you use a static safe work environment to perform this mod and you should have some technical knowledge. Also, a schematic would be helpful but is not necessary.

You will need the following parts:

Output jack (I use a 1/8 mini earphone jack but some like a BNC. The 1/8 mono jack is easier to install because you don't have to drill as big a hole in the back of the unit)

.01 uF capacitor

5 Kohm resistor (1/4 watt)

6 inches of mini coax or other shielded cable

A cable to run from the 2006 to your shortwave. I use the shielded cable that has the 1/8 plug on one end and a phono plug on the other end (1992 catalog Radio Shack P/N 42-2444 works for me). The phono plug is perfect for the antenna input of my DX440 shortwave receiver.

The first step is to remove the cover of the unit and drill a hole in the back of the 2006 for your 1/8 or BNC plug. (You will want to wrap some tape around the drill bit about an inch from the end to keep it from cruising right on into the electronics once it punches through the metal!) Solder the 5K resistor to one end of the .01 uF cap. Solder the other end of the cap to the shielded coax wire. Solder the other end of the coax to your 1/8 phono plug (or BNC) and ground the cable at this end. Now that the cable is in place you are ready to connect it to the 455 KHz source which is D33. It is on the top circuit board near the middle left, not too far from a huge capacitor. Solder the end of the resistor to the cathode of D33. (This should be the top of the standup part) Now you can test it out before you put the cover back on to make sure you did everything correct. You should be able to tune to some local airport or CB frequency on your 2006 and receive the same thing on your shortwave (with it tuned to 455 KHz and hooked up to the 2006 of course). If you tune something on your scanner that is SSB, you should be able to switch your shortwave to SSB and tune in



the signal just fine. Beware of one thing, since the 2005/6 only tunes in 5 KHz increments minimum, you may notice from time to time that the signal on your shortwave isn't real clear. It may be that you will need to tune the shortwave anywhere from 451 to 459 KHz to tune in the signal well!

If you don't succeed or this description has you baffled you probably shouldn't be doing the mod in the first place. I assume no responsibility for screwups. Good luck

David



Date: Wed, 26 Jul 89 12:04:40 EST  
From: MKELLY@CARLETON.CA  
Reply-To: "MKELLY/2020"@CARLETON.CA  
Subject: PRO 2020 SCANNER MOD

Here is the mod for the Radio Shack Pro-2020 Scanner that I posted to Info-Hams Vol 89 Issue 314, Slightly condensed. It adds another 80 memories to the existing 20, in four banks of 20, and suggests other mods.

It MIGHT be helpfull for other scanners that store frequency info in a ram separte from the cpu chip.

The address, data, and WE lines on the old and new ram are paralleled. Chip enable from the cpu is multiplexed to the old and new ram, with the mux select being driven by a high order line from a counter. The high order address lines on the new ram are driven off of the low order bits of the same counter that drives the mux. These counter lines also drive a binary->7 segment decoder/led driver to indicate which bank the machine is using. The mux output is inhibited by a power\_on\_reset signal to prevent spurious writes during power up. CE1 from the cpu goes to the input to a 1 to 2 mux (1 input, CE1; 2 outputs, OLD\_CE1, NEW\_CE1).

The mux is made of 1/2 of a 74hc00 2 input nand and 2/3 of a 74hc10 3 input nand. There is one 3 in nand unused, inputs are tied high. The 3input nands drive the ce lines on the rams. The third input on each of the two 3 in nands is driven by the power\_on\_reset line that goes to CE2 of the ram in the original machine. This signal stays low until the rest of the system is powered up and stable, preventing spurious chip selects (& writes) until the power up sequence is complete. The top 2 address lines of the new ram (1k x 4 cmos) are selected by a 4520 4 bit binary counter configured to count 0,1,2,3,4 with binary output 101 decoded with another 1/4 of the 74hc00 looking for a high on Q0 and Q2 of the counter at the same time. This signal is inverted (using the last 1/4 of the 74hc00) and fed into the clear line of the counter. The clock inputs are configured so a low on the clock will increase the count. The line(s) being used for the clock have a resistor to counter vcc and a capacitor to ground. The bank select switch is a SPST N.O. switch that shorts the capacitor.

Q2 goes to the select input of the mux. When Q2 is low, chip selects from the cpu go thru to the new ram, and when it is high, the chip selects go to the original ram, as before, like this:

| Q0 | Q1 | Q2 |                                              |
|----|----|----|----------------------------------------------|
| 0  | 0  | 0  | new ram bank 00 bank display reads 0         |
| 1  | 0  | 0  | new ram bank 01 bank display reads 1         |
| 0  | 1  | 0  | new ram bank 10 bank display reads 2         |
| 1  | 1  | 0  | new ram bank 11 bank display reads 3         |
| 0  | 0  | 1  | old ram (only one bank) bank display reads 4 |
| 1  | 0  | 1  | generate asynch reset and go back to 0 0 0   |

The bank display

is a FND367 using 470 ohm resistors to +5v. The display driver is a 4511 driven off the SECOND counter in the 4520 package. Since one of the segments in a 0-1-2-3-4 counter is always on, it is run (via its resistor) directly off +5, rather than off of the 4511.

I used rather stiff decoupling (around 100uF in parallel with .1uF) on the display "module" (4511+fnd367), and the expansion board on both +5V and +5VBACKUP lines. This may be excessive, but overkill doesn't hurt

THE NEXT TIME I'm in there, I will probably switch the 4520 power line onto the battery backup, so it will power up in the bank I left it in, rather than at any bank at random as it does now. If I were doing it again, I would drive the 4511 off the same lines as the address, rather than using the second counter in the package, because on power up, the two halves of the counter chip might have different numbers in them, causing the bank display to "lie" to you until you go to bank zero (when both halves get a reset and get synched up again) I have decided that the scan speed is too slow to make any practical use of the idea of decoding "20" in the channel number display and using it to clock the "bank" counter. With that many channels being scanned, the chances of catching anything diminish too far.

THE NEXT MOD is to put a fet switch (probably a TIS73 jfet) across the "speed" switch, with a capacitor from the gate to the switched +5V line and a resistor from the gate to ground. This should hold the "speed" key on the keypad closed on power up, so the machine starts off in "fast" speed, rather than in slow. I havent thought this one out yet, so if you beat me to it, lemme know how it works. This mode isn't the best one to send schematics through, so if you want a schematic of the mod, send me a papermail address. Mine is: Mike Kelly, Carleton University, Colonel By Dr., Ottawa, Ontario, Canada, K1S 5B6. 73.. mike k. (VE3 FFK)

-----



From: rats@ihlpm.UUCP  
Newsgroups: rec.radio.shortwave  
Subject: Realistic PRO-2022 Cellular Restoration  
Message-ID: <9109301350.AA24169@ucbvax.Berkeley.EDU>  
Date: 30 Sep 91 13:50:04 GMT  
Sender: daemon@ucbvax.BERKELEY.EDU  
Lines: 49

#### Cellular Restoration on the Realistic PRO-2022

The Realistic PRO-2022 certainly is a look-alike for the all-time popular, but now-discontinued, PRO-2005. But is the similarity only cosmetic? What tricks can be done to increase the utility of the lower-cost 2022, now available from Radio Shack and Grove Enterprises? Of the greatest interest, can cellular phone coverage, censored at the factory, be restored? Yes.

After removing the two upper back screws and the top lid, locate the black cable just behind the front panel. Adjacent to the cable are four diodes locations: D42, D43, D44 and D45.

|                |                                                                                                                                                                                                                                                                                                                            |
|----------------|----------------------------------------------------------------------------------------------------------------------------------------------------------------------------------------------------------------------------------------------------------------------------------------------------------------------------|
| D42            | is not present; installed, it adds the 68-88 MHz European mid band (which includes the US 76-82 MHz mid band), removing the US 30-54 MHz low band. Even if a switch were installed to allow the diode to be selected, additional components and realignment are necessary for that higher frequency coverage. Don't do it! |
| D43            | is present, allowing the 800 MHz band to be received; the diode may be deleted so that the same                                                                                                                                                                                                                            |
| microprocessor | may be used in scanner modles which don't have that 800 MHz capability. Don't touch it!                                                                                                                                                                                                                                    |
| D44            | is present, deleting the cellular mobile and base frequencies. If one lead is cut, total 806-960                                                                                                                                                                                                                           |
| frequency      | is restored, including 30 kHz steps in the cellular band. Keep in mind, however, that mobile telephone eavesdropping is prohibited by the Electronic Communications Privacy Act!                                                                                                                                           |

This modification may void your warrenty; it is best to cut the lead carefully, gently separating the gap slightly so that it may be resoldered in case the radio needs warrenty repair later.

|     |                                                                                                                                                                                                                |
|-----|----------------------------------------------------------------------------------------------------------------------------------------------------------------------------------------------------------------|
| D45 | is not present; installed, it makes the cellular 30                                                                                                                                                            |
| kHz | increments change to 12.5 kHz. A small SPST switch connected in series with one lead of a 1N914 or 1N4148 could allow selection of the 25 kHz step interval in those areas which utilize that channel spacing. |

To do this, it is necessary to unsolder a shield under the circuit

board which covers the solder pads for the diodes. Such a modification should only be attempted by someone familiar with electronic circuitry.

[Excerpted from Monitoring Times, June 1990, page 89.]





From: steuer@clam.rutgers.edu (robert Steuer)  
Newsgroups: alt.radio.scanner  
Subject: PRO-2026 MODS!!!  
Message-ID: <Oct.20.10.55.49.1992.11077@clam.rutgers.edu>  
Date: 20 Oct 92 14:55:50 GMT  
Organization: Rutgers Univ., New Brunswick, N.J.  
Lines: 29

Hi all, just got these mods, hot off the FAX!

Note: It is not lawful to monitor cellular or conventional mobile  
telephone conversations.

The 2026 has cellular frequencies deleted at the factory, but  
restoration is the easiest ever! - clip one marked wire! All you need  
is a Philips screwdriver and wire cutters.

1. Turn the scanner upside-down and remove the four side screws  
holding the bottom cover in place; pull the cover loose and set it  
back about two inches out of the way.

2. Locate the small circuit board at the lower right-hand corner and  
find jumper L201. Cut it and slightly separate the break.

3. Reassemble the radio which now has continuous 806-956 MHz coverage  
and 30KHz search increments in the cellular band.

\*\*\* I have not tried the above mod, but did acquire it from a  
commercial radio dealer who is very respectable, so as always, proceed  
at your own risk and realize that this will violate your warranty!

Have Fun!  
Rob KF2EK

---

-

|                    |                                           |
|--------------------|-------------------------------------------|
| Robert Steuer      | Internet: steuer@clam.rutgers.edu         |
| Rutgers University | Amateur Radio: KF2EK@N3FOA.#EPA.PA.USA.NA |

---

-



Date: 4 Apr 89 14:24:01 GMT  
Subject: PRO-34 Scanner Modifications

In the May 1989 edition of Popular Communications is a "Letter to the Editor" on the Radio Shack PRO-34 Scanner. Below is the text of that letter.

#### PRO-34 Scanner Modification

In regard to the information presented (March Issue) on the handheld Radio Shack PRO-34 scanner, my own observations on the modifications have been:

1. To restore missing 800 MHz frequencies, remove D-11.
2. To add 66 to 88 MHz (European Coverage), install a diode at D-9.
3. D-10 must remain in place for full 800 MHz coverage.
4. If a diode is added at D-13 it cuts out aero band, also seems to affect 800 MHz channel spacing.
5. D-12 added dosen't seem to have any affect.
6. Only D-10 and D-11 are factory installed.

I wish to thank you for a fine and informative magazine. I have had much reading enjoyment.

Sam S. Jones,  
Rebel Antenna,  
Falls Church, VA

--

Julian Macassey, n6are julian@bongo ucla-an!denwa!bongo!julian  
n6are@wb6ymh (Packet Radio) n6are.ampr.org [44.16.0.81] voice (213) 653-4495



From: mb@sparrms.ists.ca (Mike Bell)  
Newsgroups: rec.radio.shortwave  
Subject: PRO-37 Scanner Modifications (Long)  
Message-ID: <1991Sep24.133211.10245@sparrms.ists.ca>  
Date: 24 Sep 91 13:32:11 GMT  
Organization: Spar Aerospace Ltd, Toronto, Canada  
Lines: 143

MODIFICATIONS FOR THE PRO-37  
-----

The disassembly instructions are based on the excellent PRO-34 instructions provided by Chris Scholefield (chriss@mid.com). I have added my own comments.

First of all, what modifications are possible?  
-----

The PRO-37 uses a diode array to tell its microprocessor what model it is, and thus which frequency bands to allow and what channel spacing to use. European and Australian models have full 800 MHz coverage (at an unknown channel spacing) and a VHF-Mid band (68-88 MHz) rather than a VHF-Low band (30-54 MHz).

The Canadian and US models differ in the amount of care taken to reduce EMI. The Canadian model has additional screening, and one or two other minor component additions to achieve this. Therefore, if you have the choice, the Canadian model is preferable to the US model.

Changing from VHF-Low to VHF-Mid band coverage requires many component value changes (and realignment of the appropriate RF stage). Given that the PRO-37 uses SMT technology, it's not worth trying. (You can change the diode array easily enough, but just don't expect reasonable performance!)

The only sensible (straightforward) modification is the restoration of full 800 MHz coverage on Canadian and US models. The ranges restored appear with a 30kHz channel spacing - which just happens to coincide with the N. American cellular telephone channel spacing. A remarkable coincidence.

The modification described is therefore applicable ONLY to Canadian and US models. (European and Australian readers could always remove 800 MHz coverage if they wished:-).

You will need:

|                       |                                            |
|-----------------------|--------------------------------------------|
| Soldering iron        | - with a fine point. (The                  |
| components desoldered |                                            |
| but ....)             | and soldered are not SMT,                  |
| Desoldering tool      | - to remove excess solder                  |
| Philips screwdriver   | - if it fits the screws on the back of the |
|                       | case it's the right size.                  |
| Small pliers          | - bending component leads                  |
| while unsoldering     |                                            |

and removing hexagonal posts  
Earthing wrist strap - strongly advisable with CMOS components.  
(Static can cause premature,  
if not immediate failure of components). Wear  
this at all times.  
Small screwdriver - for prying components etc.  
Experience and confidence in working with modern electronics  
A couple of hours without interruptions...

## Instructions

- 
0. READ THROUGH ALL OF THESE INSTRUCTIONS BEFORE STARTING!
  1. Remove the battery
  2. Remove the antenna
  3. Pull to remove squelch and volume knobs
  4. Unscrew the 4 screw on the back of the case
  5. Separate the case beginning at the battery end and work over the circuit board and knobs at the top
  6. Unsolder both connections to the antenna - ground can be bent away and the centre has a link to the board
  7. Unsolder the two power switch links at the board end
  8. Unsolder the ground connections to the metal shield
  9. Disconnect the two connectors to the squelch and volume controls
  10. Remove 4 hexagonal posts
  11. The top board may now be removed by separating it gently from the connector on the adjacent board
  12. Remove 3 screws holding the shield in place
  13. Lift the shield to separate it from the lower control circuit board
  14. Identify diodes D12, D13 on the control board
  15. EITHER cut the diode D13 and SKIP to reassembly OR continue to desolder diode
  16. Remove last two screws and remove control board. Take care not to dislocate the KEY LOCK switch when doing this.
  17. Unsolder screening from side of control board near diode array,

and bend back out of way.

18. Unsolder and remove diode D13. Keep it somewhere so that you can replace it if required to do so by US legislation.

Reassembly is the reverse of the above procedure.

If you performed steps 16-18 CHECK REALLY CAREFULLY that the metal part of the KEY LOCK switch is in the right location. (Otherwise, you may find yourself having to disassemble the whole thing again - I know, I did!)

NOTES.

1. One must exercise great caution in the procedure. Check that no flakes of solder get dropped on the boards. Take anti-static precautions by doing the work on a mat and wearing a wrist strap. Do not make any adjustments to the upper analogue board or bend any of the other wire links on it, which are tuned circuits.
2. Another caution is that doing any of the work will probably violate any warranty you may have on the scanner. Might be worth burning the scanner in for ~150 hrs before attempting this to reduce the risk of a latent component fault appearing after you have made the modification.
3. YOU PERFORM THE ABOVE PROCEDURE ENTIRELY AT YOUR OWN RISK. You may wish to obtain a copy of the PRO-37 Service Manual from Radio Shack before attempting this. (Cost about \$20 - well written - just wish I could afford all the service gear required!)
4. If you happen to find out what adding D14 does (another difference between N. American and European/Australian versions), I'd be interested to know. It's not mentioned in the service manual. I think it could affect 800 MHz channel spacing - any info on the European Australian PRO-37 specs in this area would be appreciated.
5. If you found something wrong in the above instructions, let me know and I will try and post an update.
6. If you found all this helpful, help someone else and donate \$5.00 \*today\* to your favourite charity.

Share and Enjoy!

-- Mike -- <mb@sparrms.ists.ca>

From: tvervaek@col.hp.com (Tom Vervaeke)  
Newsgroups: alt.radio.scanner  
#Subject: Re: PRO-37 MOD's  
Date: 14 Dec 1992 16:14:44 GMT  
Organization: HP Colorado Springs Division  
Lines: 207  
Message-ID: <lgibtkINNivs@hp-col.col.hp.com>  
References: <1992Dec14.144614.12123@bmerh85.bnr.ca>  
NNTP-Posting-Host: itchub21.cs.itc.hp.com

---

PRO-37

This works. I have used this procedure to modify my pro37. One note: there is no reason to remove the logic board. If you have skinny wire cutters, you can easily get to the correct diode. This will save you the trouble of getting the key pad and key lock back together properly.

Restoring the full 800Mhz coverage of the RS Pro-37 scanner.

The following notes have been shamelessly plagiarized from Mark Miller's excellent instructions on modifying the Pro-34. The two scanners are physically so similar that I needed to make only a few minor changes in Mark's notes to make them fit the Pro-37.

-----

The instructions below are for those that don't like to completely disassemble every new electronic toy they buy just to see how it works. Nor is it for the guy that has been building their own equipment since the days of the first tube diode. This set of instructions assumes a moderate level of skill with a soldering iron, and some simple hand tools. It is aimed at those who just want the additional coverage from the mods but haven't been building kits for a decade.

lets just call these ....

"NOVICE NOTES" FOR PRO-37 MODIFICATIONS

1. Remove the 4 small phillips screws on the back of the unit
2. Remove the battery cover and battery holder from the case. You won't lose your programming as long as you don't take all day to do this.
3. Remove the two knobs on the top of the case (Volume & Squelch)
4. The case snaps together at the bottom via two molded "hooks" in the back half of the case which fit into two indentations in the front half. These can be snapped apart by applying the right leverage to bend the hooks away from the indentations that they fit into while pulling the case apart. You'll see what I mean when you look at it. You need to be a bit careful in forcing the two halves of the case shell apart. Once you have the snaps at the bottom released, angle up the bottom of the case until the battery separation wall is clear of the internal metal frame, and slide towards the top of the unit. Place the back half of the shell aside.
5. Now you will see the RF board mounted to the metal support frame. The BNC (antenna) connector leads and the volume control power switch leads are soldered directly to the board. Carefully desolder these 4 connections.



7. There will be a wire from the volume control knob to the PC board that is plugged in. Remove the plug from the RF board (needle nose pliers work)
8. There will also be a similar wire (small shielded ) from the squelch control  
to the RF board wich is also plugged in. Remove the plug from the RF board.  
(Again Needle Nose Pliers work good here)
9. Remove the 4 threaded hex stand-offs from the RF Board (these hold the RF board to the internal metal frame AND are where the screws that hold the back of the case screw in) Use a nut driver or Needle Nose Pliers.
10. Now the RF board is mostly free. The only thing holding it in is the row of connector pins on its botom side that plug into the logic board. You will need to pry this board up gently. Be warned that the bottom side of the RF board is just chock full of Very Small surface mounted components. So use something non-metalic and smooth to do the prying with.
11. Set the RF board aside.
12. The Internal Metal support frame is now exposed. there are 3 small phillips  
screws holding the metal frame to the bottom Logic board (actually, these screws go through the logic board and into the front half of the case)  
2 of the screws are near the top, and 1 is at the bottom of the metal frame.  
Remove these 3 screws.
13. There is a small socketed wire that leads from the small power pc board on the metal frame that goes under it and is plugged into the Logic board. Lift the metal frame up and remove the power plug from the PC board. Place the metal frame with the rest of your parts pile.
14. You have the component side of the Logic board exposed now. There are 2 small phillips screws at the bottom of the PC board (where the Battery compartment WAS) Remove them.
15. Once you have the the last 2 screws removed the Logic board is free. The speaker wires lead from the speaker to the logic board on the bottom side. These are soldered in butthere is enough play in them to allow you to make the mods.
16. NOTE: The keyboard lock switch is a funky little piece of plastic with a sliding stainless metal contactor that is just wedged in between the front case and the logic board. Remove both the switch contacts and the plastic switch. (best know it now or loose them in the carpet)  
ALSO: don't touch the innards of the keyboard itself, which will now be exposed. It appears that the keys make direct contact with pads on the circuit board, and you don't want grit and skin oil to be getting in there.
17. On the component side of the PC board you will see lots of nifty surface mounted components, a box-like capacitor (used for maintaining the channel freqs while you change the batteries.. and make modifications :) near the edge of the PC board you will see a couple of small diodes

mounted

vertically. These will be labeled on the PC board as D12 and D13. You will also see places for two other diodes to be soldered in (labeled D11 and D14) but nothing is installed in these.

- 18. Now carefully clip the lead coming from D13 and bend the diode away slightly to make a gap between the resulting two pieces of wire. Clip it near the middle to leave plenty of room to resolder, in case you ever want to undo the mod.

You have completed the mod for complete 800mhz band coverage.

Follow the same steps backwards (18->1) and replace "remove" with "replace" and "desolder" with "solder"

N.B. These instructions are from last night, All the steps are in correct order as well as the general information. The diagrams are from memory so components may not be in the exact location indicated, but they will be very close.

LASTLY, Now that you have made the mods, you can use the warranty card to light the Bar-B-Q Grill with.

##### DIAGRAMS #####

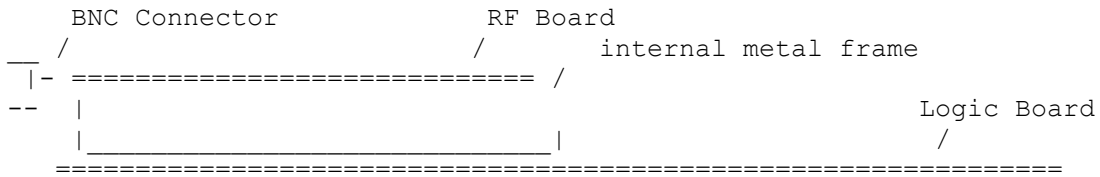

SIDE VIEW OF RF-BOARD, METAL FRAME, LOGIC BOARD

-----

L E G E N D

|-----

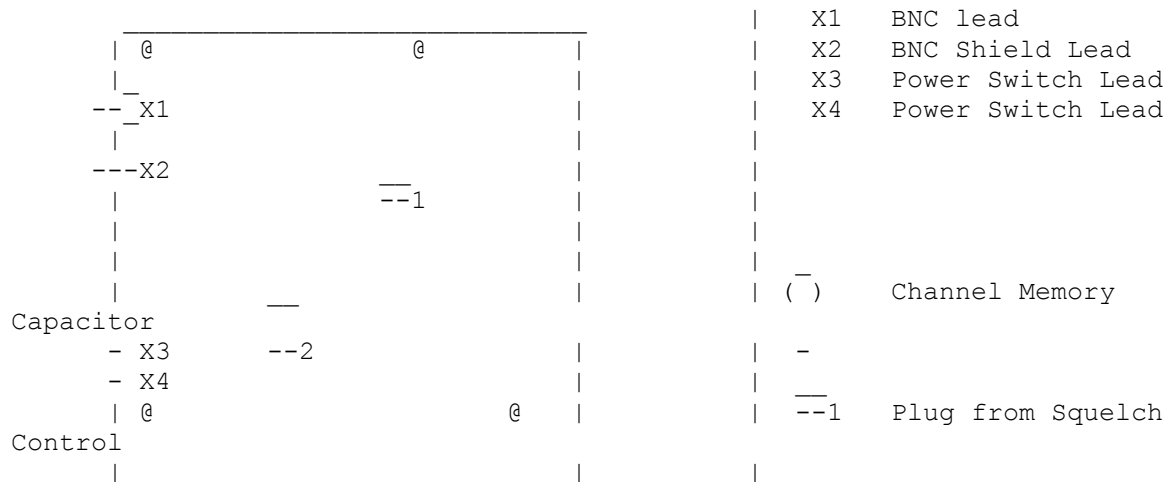

TOP OF RF-BOARD

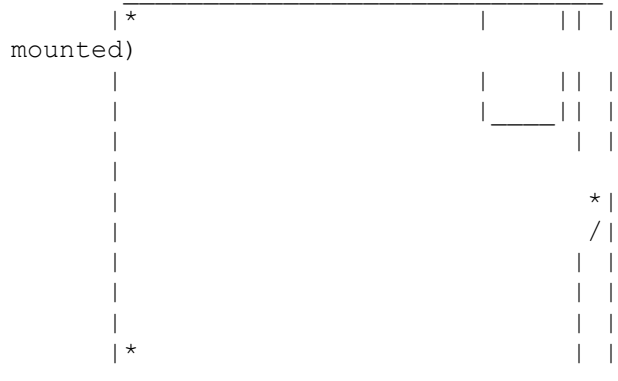

TOP OF INTERNAL METAL SUPPORT FRAME

- 2 Plug from Volume Contol
- @ Threaded Stand-off
- \* Phillips Screws
- 0 Diode (vertical
- . Unoccupied space for diode

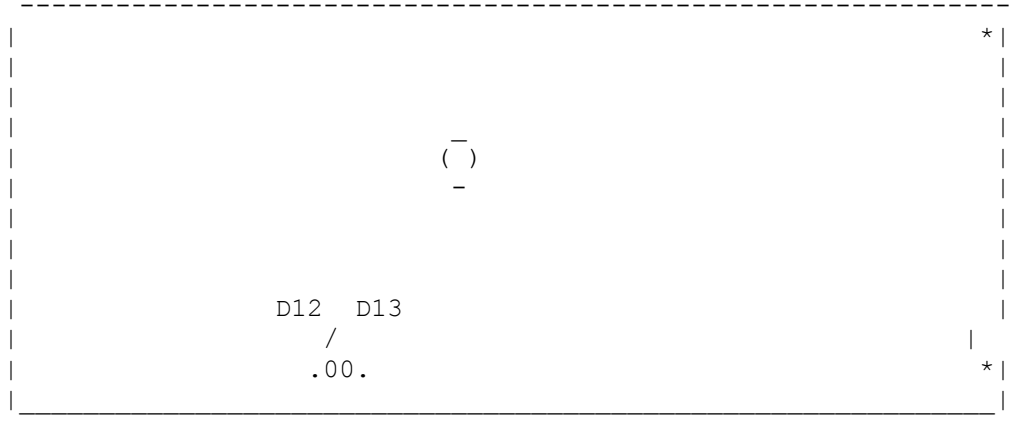

COMPONENT SIDE OF LOGIC BOARD

--  
Happiness is being a cynic, That way everything Sucks.



Newsgroups: alt.radio.scanner  
From: riyadth@boi.hp.com (Riyadth Al-Kazily)  
Subject: A (useless?) modification for the PRO-38  
Sender: news@mail.boi.hp.com (News Server Project)  
Message-ID: <ByrCr7.Mvy@mail.boi.hp.com>  
Date: Fri, 4 Dec 1992 23:18:42 GMT  
Organization: Hewlett-Packard Company / Boise, Idaho  
Lines: 95

Modifications for the Radio Shack PRO-38 10ch scanner

These PRO-38 modifications may also apply to the current PRO-41, and the Uniden BC50XLT and BC55XLT scanners, which appear to be the same unit in different packaging.

Initially I wanted to enable my scanner to receive TV audio bands, just for fun. This started a quest for modification information, and I learned a lot about what can and can't be done with a scanner. Unfortunately, I didn't learn until after I performed this modification that TV audio (and FM radio) is broadcast in WFM (wideband FM), but most scanners only receive NFM (narrow-band FM). This results in major garbling of the sound when the scanner is tuned to a TV audio frequency.

Anyway, on with the modification. I purchased the Realistic Service Manual for the PRO-38, part number 20-139, for a paltry \$5.28 and a 1 week order delay. In it I found quite a bit of useful information. It contains full board layouts, a block diagram, a detailed schematic, and some pinout information for the UNIDEN UC-1143 microprocessor which controls frequency selection. This is in addition to the test and alignment procedures. There is even a nifty reset/test mode [WHICH ERASES STORED FREQUENCIES!], switch on while depressing 2-9-MANUAL. This programs all channels to test frequencies.

The first thing I found was the ability to select U.S. or European band coverage, through a jumper on the CPU board. Installing this jumper (normally missing in the U.S.) changes the VHF-low frequency range from 29-54MHz to 66-88MHz. This looked very much like what I wanted for at least some of the TV audio reception. But it sounded like garbage, then I found out about WFM/NFM... So I removed this mod (I don't know of any frequencies in that range that would be useful).

I looked through the service manual some more, and found that there were 3 pins on the processor that appeared to be inputs (from the test voltages given in the manual) yet were not used or given any other designation. I grounded each one of these pins, as I did with the European mode jumper, and tested the results. Only one of them made any difference, and it too is probably useless. What it did was to change the VHF-high frequency range from 136-174MHz to 118-174MHz. This extends the frequency coverage into the aircraft band, but this band is AM, and this radio does not have any AM detector circuitry (as far as I know).

I was hoping that some magic pin would enable 16 channels (as on the similar mobile PRO-2025), but I couldn't find one. There is the possibility of more keys being added, as the scan matrix is 3x8, but

only 16 keys are used (8 more could be added). The PRO-2025 has 2 more buttons, PRIORITY and WX (weather), and both of these features would be nice. Maybe someone else has some ideas? I was thinking of getting the PRO-2025 service manual, to see the differences, but I may just get a better scanner and be done with it :-)

If anyone out there can come up with more modifications or information about this scanner, please let me know. There are quite a few of us out there that have simple scanners like this, and we would like to get more out of them. Not all beginners go straight to a PRO-2006, after all :-)

#### THE MOD:

##### European band selection:

1. Add a jumper to the digital board, connecting the empty pads near the upper left corner of the IC when looking at the board from the component side (display up/speaker down - facing away from you). When completed you should be able to power up and enter frequencies in the 66-88MHz range, with frequencies in the 29-54MHz range resulting in E(rror). Note, it should be possible to place a small switch on this jumper so that the unit can change from European to US modes (probably only when powered off). Once a frequency is entered into memory, it can be received no matter what bands are enabled.

##### FM "Air-band" coverage:

2. Add a jumper between pin 67 of the microprocessor and ground. Pin 67 is one down from the pin connected to the pad used in the European band selection, it is the third from the top on the left side of the chip. Ground can be obtained at the opposite side of the European band jumper pad. Be very VERY careful while soldering to the pins of the surface mount chip, and have a VERY fine soldering iron tip.

Once the jumper is in place, frequencies can be entered in the 118-135MHz range, and no other range is lost.

If you think I take any responsibility for any errors on your part (or on my part for that matter), you have another thing coming. No warranty is expressed or implied. Use at your own risk.

--

```
[ Riyadhth Al-Kazily  riyadth@hpdmd48.boi.hp.com riyadth@hpbs1904.boi.hp.com ]
[ (208) 323-4987      | When am i going to have time to use all this   ]
[ Boise, Idaho       | stuff I'm collecting? More important, how can   ]
[ DoD #295 1983 BMW R65 | I get more stuff? Amiga 500+ (+ stuff, that is) ]
```



From: ag684@cleveland.Freenet.Edu (Mark Stephany)  
Subject: Re: Mods for PRO-43  
Date: 18 Oct 92 13:18:07 GMT

This is what I've got on the Pro-43, not my words.

=====

#### PRO-43

A few people have mentioned the cellular mod for the PRO-43; it turns out you should not remove but MOVE the diode. Doing so allows cellular coverage as well as low band (up to 88 MHz) coverage.

#### PRO-43

##### Cellular Frequency Restoration and Low Band Expansion

Note: It is not lawful to monitor cellular or conventional mobile telephone conversations.

The following procedure requires familiarity with microcircuit soldering and will violate your warranty. Grove Enterprises assumes no liability resulting from its attempt, nor will accept the modified scanner for return under any condition.

TOOLS NEEDED: Fine point, low power soldering pencil; solder wick or a desoldering tool; pointed awl, hemostats or pointed tweezers; small Philips screwdriver; solder.

- 1) Remove the battery, antenna and back cover (held in place by four screws).
- 2) Remove the six screws holding the top circuit board in place. Carefully unsolder the two antenna connections from the board. Bend the antenna ground tab fully up from the board. Carefully lift the board, unplugging the black connector at its base, and lay the board out of the way on its bundle of colored wires.
- 3) Remove the two screws from the next board and lift it, carefully unplugging the white connector at the bottom of the board. Lift it up and lay it aside on its brown wire (which can be unplugged if necessary).
- 4) Unsolder and remove the metal shield from the final board, revealing the microprocessor; note the row of diodes labeled D1-D5 above it. Only diodes D1, D2, and D4 are present; assisted by a pointed tool, unsolder and remove D4, the lone diode (this restores cellular frequencies which will be searched in 30 kHz steps).
- 5) Resolder the removed diode carefully into position D3 to extend low band coverage to 88 MHz.



6) Reassemble the boards, paying particular attention to the alignment of the plugs. Test the radio by entering any frequency between 870 and 890 MHz (cellular) and 51-88 MHz (low band).

---

From: horak@convex.com (David Horak)  
#Subject: Re: Mods for PRO-43  
Date: 19 Oct 92 17:14:41 GMT

I would be very careful about re-installing the diode for 51-88 coverage. In earlier Pro34/37 models, this could be done too (I did it). The scanner would indeed program the new frequency limits, but would not pick up anything in that band. I later discovered that I would have to re-align the receiver to pick up anything. Also, in the 34/37 models, restoring the 54-88 band REMOVES the 30-54 band! I had an external toggle switch, so I could go back and forth but it was of little use, since the radio had to be re-aligned each time I wanted to change bands. The Pro-43 is a different animal, so I can't say for sure what it can/can't do. Just beware of the possible problems of restoring the 51-88 band.

David



This file is meant to replace the old PRO-43 mod file. 17.12.92

From: armille@afterlife.ncsc.mil (A. Ray Miller)

Summary: cellular (870-890 MHz) and low band (51-88 MHz) restoration for PRO-43

A few people have mentioned the cellular mod for the PRO-43; it turns out you should not remove but MOVE the diode. Doing so allows cellular coverage as well as low band (up to 88 MHz) coverage.

Acknowledgments to Grove Enterprises; this information came from them. They are selling the PRO-43 for \$300 which is \$50 less than Radio Shack. I have no connection with them other than as a satisfied customer.

#### PRO-43

#### Cellular Frequency Restoration and Low Band Expansion

Note: It is not lawful to monitor cellular or conventional mobile telephone conversations.

The following procedure requires familiarity with microcircuit soldering and will violate your warranty. Grove Enterprises assumes no liability resulting from its attempt, nor will accept the modified scanner for return under any condition.

TOOLS NEEDED: Fine point, low power soldering pencil; solder wick or a desoldering tool; pointed awl, hemostats or pointed tweezers; small Philips screwdriver; solder.

- 1) Remove the battery, antenna and back cover (held in place by four screws).
- 2) Remove the six screws holding the top circuit board in place. Carefully unsolder the two antenna connections from the board. Bend the antenna ground tab fully up from the board. Carefully lift the board, unplugging the black connector at its base, and lay the board out of the way on its bundle of colored wires.
- 3) Remove the two screws from the next board and lift it, carefully unplugging the white connector at the bottom of the board. Lift it up and lay it aside on its brown wire (which can be unplugged if necessary).
- 4) Unsolder and remove the metal shield from the final board, revealing the microprocessor; note the row of diodes labeled D1-D5 above it. Only diodes D1, D2, and D4 are present; assisted by a pointed tool, unsolder and remove D4, the lone diode (this restores cellular frequencies which will be searched in 30 kHz steps).
- 5) Resolder the removed diode carefully into position D3 to extend low band coverage to 88 MHz.

6) Reassemble the boards, paying particular attention to the alignment of the plugs. Test the radio by entering any frequency between 870 and 890 MHz (cellular) and 51-88 MHz (low band).

--

A. Ray Miller  
arm@super.org | armille@afterlife.ncsc.mil

=====

From: ross@novax.llnl.gov  
Date: 19 Aug 92 16:51:08 GMT

Here is my keypad beep delete mod for the RPO-43:

1. Remove battery.
2. Remove back cover (4 screws).
3. Remove top board (6 screws, desolder two antenna connections and bend antenna ground lead up out of the way). Be careful of black connector at bottom of board. Flip board over and lay aside (wire connectors need not be disconnected).
4. Remove middle board (remove 2 screws and wire connector). Be careful of two multi-pin connectors along underside of board. Set middle board aside.
5. Locate 10 pin connector on side of bottom board (labeled CN3). Note that one end of connector has pin 10 labeled as such. Count back to pin 6 and bend pin 6 ninety degrees towards the large RF shield. Make sure the bent pin clears the RF shield.
6. Reassemble and your done OR do the cell mod since you are so close.

Have fun. Gary Ross >usual disclaimer>

-----

Subject: Improved audio for the PRO-43 portable scanner  
From: parnass@cbnewse.cb.att.com (Bob Parnass, AJ9S)  
Date: Wed, 2 Dec 1992 01:15:35 GMT

#### IMPROVED AUDIO FOR THE PRO-43 SCANNER

by Bob Parnass, AJ9S

The Radio Shack PRO-43 scanner audio is too bassy.1 The lack of treble makes it difficult to hear the PRO-43 in noisy situations, especially while listening in a car or truck. Louis Shirley sent me a schematic and suggested I remove C341, a tiny 0.015 ufd surface mount capacitor.

I'm glad to report that removing C341 made a great improvement. The audio is now much "crisper," more like the Uniden 200xlt, although still not quite as loud. Turning the volume control up still overloads the PRO-43's small, internal speaker, but there's less need to do that once C341 is removed.

The PRO-43 contains 3 printed circuit boards, and the middle (second) board contains the audio circuitry. Finding C341 is difficult, as it is neither marked with a value nor a component designation. It is located on the foil side of the middle board, under IC304, an LM386 amplifier IC. C341 is in parallel with, and physically next to, R350 (33,000 ohm). R350 is slightly larger than C341 and is marked 333. Both R350 and C341 are connected between pin 2 of the LM386 and ground.

#### A Note About 50-88 MHz Reception

Now that I have a schematic, I see that the European version of the PRO-43 has different coils and capacitors in the low (mid) band front end filter. That explains why the 75 MHz sensitivity isn't stellar after adding diode D3 to enable 30-88 MHz coverage.

- 
1. See "PRO-43 Product Review," by Bob Parnass, AJ9S, in the November 1992 RCMA Journal.

--

=====  
Bob Parnass, AJ9S - AT&T Bell Labs - [parnass@ihlpm.att.com](mailto:parnass@ihlpm.att.com) - (708)979-5414

=====  
Compiled for [garfield.catt.ncsu.edu](mailto:garfield.catt.ncsu.edu) by:

Brad Steinman  
University of Toledo Computer Services  
[cscon0151@uoft02.utoledo.edu](mailto:cscon0151@uoft02.utoledo.edu)



From: armille@afterlife.ncsc.mil (A. Ray Miller)  
Newsgroups: alt.radio.scanner  
Subject: TWO frequency mods for the PRO-43  
Summary: cellular (870-890 MHz) and low band (51-88 MHz) restoration for PRO-43  
Message-ID: <1992Aug20.045656.5971@afterlife.ncsc.mil>  
Date: 20 Aug 92 04:56:56 GMT  
Distribution: usa  
Organization: The Great Beyond  
Lines: 51

A few people have mentioned the cellular mod for the PRO-43; it turns out you should not remove but MOVE the diode. Doing so allows cellular coverage as well as low band (up to 88 MHz) coverage.

Acknowledgments to Grove Enterprises; this information came from them. They are selling the PRO-43 for \$300 which is \$50 less than Radio Shack. I have no connection with them other than as a satisfied customer.

PRO-43  
Cellular Frequency Restoration and Low Band Expansion

Note: It is not lawful to monitor cellular or conventional mobile telephone conversations.

The following procedure requires familiarity with microcircuit soldering and will violate your warranty. Grove Enterprises assumes no liability resulting from its attempt, nor will accept the modified scanner for return under any condition.

TOOLS NEEDED: Fine point, low power soldering pencil; solder wick or a desoldering tool; pointed awl, hemostats or pointed tweezers; small Philips screwdriver; solder.

- 1) Remove the battery, antenna and back cover (held in place by four screws).
- 2) Remove the six screws holding the top circuit board in place. Carefully unsolder the two antenna connections from the board. Bend the antenna ground tab fully up from the board. Carefully lift the board, unplugging the black connector at its base, and lay the board out of the way on its bundle of colored wires.
- 3) Remove the two screws from the next board and lift it, carefully unplugging the white connector at the bottom of the board. Lift it up and lay it aside on its brown wire (which can be unplugged if necessary).
- 4) Unsolder and remove the metal shield from the final board, revealing the microprocessor; note the row of diodes labeled D1-D5 above it. Only diodes D1, D2, and D4 are present; assisted by a pointed tool, unsolder and remove D4, the lone diode (this restores cellular frequencies which will be searched in 30 kHz steps).

5) Resolder the removed diode carefully into position D3 to extend low band coverage to 88 MHz.

6) Reassemble the boards, paying particular attention to the alignment of the plugs. Test the radio by entering any frequency between 870 and 890 MHz (cellular) and 51-88 MHz (low band).

--

A. Ray Miller  
arm@super.org | armille@afterlife.ncsc.mil





Newsgroups: alt.radio.scanner  
From: parnass@cbnewse.cb.att.com (Bob Parnass, AJ9S)  
Subject: Improved audio for the PRO-43 portable scanner  
Organization: AT&T Bell Laboratories, Naperville, IL  
Date: Wed, 2 Dec 1992 01:15:35 GMT  
Message-ID: <1992Dec2.011535.16065@cbnewse.cb.att.com>  
Keywords: scanner radio, audio, modification, midband sensitivity  
Lines: 45

x

#### IMPROVED AUDIO FOR THE PRO-43 SCANNER

by Bob Parnass, AJ9S

The Radio Shack PRO-43 scanner audio is too bassy.1 The lack of treble makes it difficult to hear the PRO-43 in noisy situations, especially while listening in a car or truck. Louis Shirley sent me a schematic and suggested I remove C341, a tiny 0.015 ufd surface mount capacitor.

I'm glad to report that removing C341 made a great improvement. The audio is now much "crisper," more like the Uniden 200xlt, although still not quite as loud. Turning the volume control up still overloads the PRO-43's small, internal speaker, but there's less need to do that once C341 is removed.

The PRO-43 contains 3 printed circuit boards, and the middle (second) board contains the audio circuitry. Finding C341 is difficult, as it is neither marked with a value nor a component designation. It is located on the foil side of the middle board, under IC304, an LM386 amplifier IC. C341 is in parallel with, and physically next to, R350 (33,000 ohm). R350 is slightly larger than C341 and is marked 333. Both R350 and C341 are connected between pin 2 of the LM386 and ground.

#### A Note About 50-88 MHz Reception

Now that I have a schematic, I see that the European version of the PRO-43 has different coils and capacitors in the low (mid) band front end filter. That explains why the 75 MHz sensitivity isn't stellar after adding diode D3 to enable 30-88 MHz coverage.

---

1. See "PRO-43 Product Review," by Bob Parnass, AJ9S, in the November 1992 RCMA Journal.

--

=====  
Bob Parnass, AJ9S - AT&T Bell Labs - parnass@ihlpm.att.com - (708)979-5414





6. x is existing PRO-43 circuitry

If you use an analog meter, preferably a real S-Meter like salvaged from an old junked CB rig, then rig it as follows to connect to the circuit above:

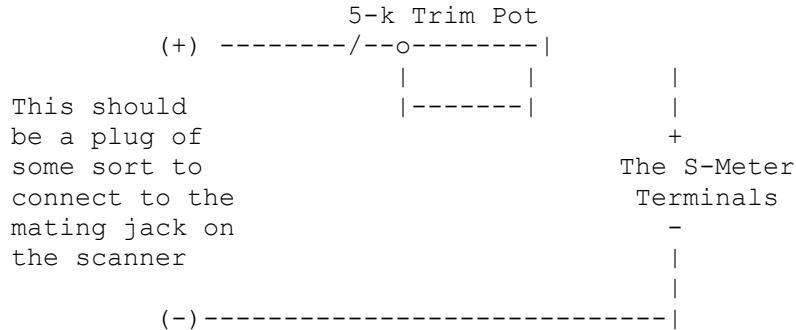

You can also build the 10-segment LED S-Meter as shown in Volume 2 of my SCANNER MODIFICATION HANDBOOK, available from leading mail order radio dealers everywhere. ISBN 0-939780-14-3 published by CRB Research Books, Inc. Commack, NY.

After connected and working, locate the PRO-43 very near a known strong transmitter, perhaps a ham transmitter, a police cruiser, your favorite security guard's handheld or right next to a cordless telephone, or anything else known to transmit a strong signal. Tune the scanner to the frequency, and adjust the 5-k trim pot above so the meter reads exactly full scale. All other signals will read proportionally lower to yield "relative signal strength" measurements! A hell of a circuit here, boys & girls! Have fun!

Developed & distributed by: Bill Cheek  
COMMtronics Engineering  
PO Box 262478  
San Diego, CA 92196-2478

Ok to distribute, but credit appreciated. Thanks!

Bill Cheek

--- GEcho 1.00/beta+

\* Origin: Hertzian Intercept, San Diego (6pm-1pm) 619-578-9247 (1:202/731.1)



From: wa2ise@cbnewsb.cb.att.com (robert.f.casey)  
Newsgroups: rec.radio.amateur.misc  
Subject: PS50 fix  
Message-ID: <1991Dec10.043500.26138@cbfsb.att.com>  
Keywords: mod  
Sender: news@cbfsb.att.com  
Organization: AT&T Bell Laboratories  
Date: Tue, 10 Dec 1991 04:35:00 GMT  
Lines: 41

copied from packet:

| Msg# | TSF | Size | #Rd | Date   | Time | From  | MsgID        | To             |
|------|-----|------|-----|--------|------|-------|--------------|----------------|
| 8740 | BF  | 1561 | 0   | 07-Dec | 0501 | KD2EJ | 28375_WB2QJA | INFO@ALLBBS () |

Sb: PS-50 IMPROVE VOLTAGE SURGE

\*\*\*\*\*  
Info sheets downloaded from Kenwood BBS in California.  
Permission has been granted as stated in the READ.ME file on the BBS  
for anyone to relay these bulletins without requesting compensation.

These bulletins have not been modified in any way.

\* COPYRIGHTED KENWOOD CORP. U.S.A.

\*\*\*\*\*

SB-916

PS-50 Improved Voltage Surge Protection

5-23-86

We have received a few reports regarding the loss of transistor Q4, resistors R2, and R3, and zener diode D4 on the AVR UNIT. Apparently a voltage surge on the power input might cause D4 to short. If this occurs the surge current thru resistors R2 and R3 could be high causing the failure of the two resistors and Q4.

Procedure:

On the AVR unit X43-1520-00 open or remove diode D4.

If you receive a unit with no output voltage check D4, R2, R3 and Q4. You should replace R2, R3, and Q4 if there is any sign of damage to any of these components.

This change applies to serial numbers before 7040001.

Time required for this change is 1/2 hour or less.

(c) 121589TKC

=====  
I haven't tried or verified this, proceed at your own risk. WA2ISE





From: wa2ise@cbnewsb.cb.att.com (robert.f.casey)  
Newsgroups: rec.radio.amateur.misc  
Subject: R5000  
Keywords: mods  
Message-ID: <1991Dec10.044014.26455@cbfsb.att.com>  
Date: 10 Dec 91 04:40:14 GMT  
Sender: news@cbfsb.att.com  
Organization: AT&T Bell Laboratories  
Lines: 26

copied from packet:

| Msg# | TSF | Size | #Rd | Date   | Time | From  | MsgID        | To             |
|------|-----|------|-----|--------|------|-------|--------------|----------------|
| 8739 | BF  | 946  | 0   | 07-Dec | 0504 | KD2EJ | 28376_WB2QJA | INFO@ALLBBS () |

Sb: R-5000 IMPROVE VOLTAGE SURGE

SB-919

R-5000 No Freq. Change thru Computer Interface 7-21-87

R-5000 receivers below serial number 804xxxx may not change frequency when operated with a personal computer/interface. To allow correct operation, rplace IC-52 on the Control Unit. The correct part number for IC-52 is MBM27C128-25JA2.

CAUTION:

The R-5000 incorporates CMOS technology. Observe precautions for handling electrostatic sensitive devices.

This modification may be performed under warranty.  
Time required for this change is 1/2 hour or less.

(c) 121589TKC

=====  
Note: I haven't tried or verified this, proceed at your own risk. WA2ISE



Date: 13 Jan 89 19:24:00 GMT  
Subject: R7000 Display/Sensitivity Problem

If you are having trouble with you Icom R7000 display being flaky and then a sudden decress in sensitivity try the following:

PROBLEM: ICOM R7000 radios that are used 24 hours a day for a long time (2 years ) when shut off the display will become flaky and it is also possible for a lost in overall gain (3 to 40 db).

SOLUTIONS: Officially there is ICOM ECO SB# 9288-004, attached below.

Unofficially from Tech who repairs R7000  
The ECO does help the display problem, but most likely it is not the problem. \*

\* note repairing your own radio my void you warranty and only allow a qualified technician to do the job, otherwise damage could happen to your R7000. If the VCO does not track then a major alignment would have to be done after. Check the ICOM IC-R7000 Service Manual for more details before starting this repair, and to make sure I have not made any typeing errors you should get a copy of the ECO from ICOM !

1st SOLUTION:

Replace on the DC to DC Board the following capacitor.  
Check the noise with an oscilloscope on both sides of R3, if the noise is not way down on one side then replace C2 a 33uf 16V capacitor. Noise feedback can decress the overall sensitivity of the R7000.

Replace on the Display Board  
C19 and C20 a 10 uf 16VDC capacitor

I found that on my R7000 C19 & C20 were the cause of my display problems. They are 10 uf eletrolytics capacitors that are lemmon yellow pc mounted units, when they go bad the base of the yellow caps change to a brown color.

I put in the following ECO first but it did not help. If you look at the service manual you will see that the ECO values are on the schematic but my unit had the old values. I suggest that you check the above first, it is a lot easier to do, C19/C20 can be done in 10-15 min while the ECO will take about a hour.

2nd SOLUTION: The ECO

ICOM America, INc  
2380-116th Ave, N.E.  
Bellevue, Washington 98004  
206-454-7619

SERVICE BULLETIN

UNIT MODEL           R7000  
SB#                   9288-004  
EFFECTIVE DATE        4/1/88  
SERIAL # AFFECTED:    ALL  
PRODUCT GROUP:        Amateur

BACKGROUND INFORMATION:

Display failure do to weak components

TECHNICAL INFORMATION:

Improvement in DC to DC converter and display power supply.

| PARTS AFFECTED  | BOARD TYPE     | CHANGE TO    | NEW PART NUMBER |
|-----------------|----------------|--------------|-----------------|
| Q1/Q2 2SC 1214  | DC to DC Board | 2SC 2655     | 906-00385       |
| R1/R2 3.3 KOHM  | DC to DC Board | 5.16 K       | 915-01173       |
| C3/C4 PF        | DC to DC Board | 0.001 MF 50V | 918-01500       |
|                 | ceramic cap    |              |                 |
| Q11/Q12         | Display Board  | 2SC2655      | 906-00385       |
| R31/R32 3.3KOHM | Display        | 5.16k Ohm    | 915-01173       |
| C13/C16         | Display        | 0.001 MF     | 918-01500       |

DETAIL PROCEDURE:

1. Remove top and bottom cover.
2. Remove front panel sub-assembly from main chassis of radio
3. Remove the DC to DC board and replace components as listed
4. Reinstall DC to DC board.
5. Replace front panel sub-assembly onto main chassis of radio
6. Replace top and bottom covers.

ESTIMATE TIME TO COMPLETE IS 1 hour

Page 2 of the ECO has a new schematic but no information

-----end of ECO-----



Date: Thu, 15 Jun 89 23:19:24 PDT  
From: wim@hlis00.enet.dec.com (Wim Beekman @UTO - PA3AGZ - DTN 838-2088)  
Subject: R7000 modifications

Newsgroups: rec.ham-radio  
#Subject: Icom R-7000 Anthology  
Posted: 12 Oct 88 21:52:03 GMT  
Organization: AT&T Bell Laboratories - Naperville, Illinois

Here is a repost of just a few of the articles about the Icom R-7000 receiver posted to the net over the past years. There were also articles on interfacing Icom equipment with computers, but I have not included them in this posting.

- 1 -

#### EXAMINING THE ICOM IC-R7000 RECEIVER

Bob Parnass, AJ9S

The long awaited ICOM R7000 is here. I bought my R7000 (S/N 001400) on June 14, 1986 from Spectronics, and agree with other R7000 owners: ICOM did their homework on this radio.

I had several questions about the R7000 that were not answered in ICOM's advertisements, and could only be answered by fiddling with the real thing:

1. Can one set the R7000 to behave like a "normal" scanner, waiting for a transmission to complete before resuming the scan? Contrary to the review in July Monitoring Times, the answer is YES. There are 4 choices of when to resume scanning (or seaching), and this is one of them.
2. Does the R7000 have a "search and store" mode, like the old Bearcat 250? Yes, and it's well done. There is a mode which will search between two frequency limits, and store the active frequencies in the top 20 channels. The R7000 is smart enough not to store duplicate frequencies.
3. Does the R7000 use the concept of a "channel bank"? Yes, one can select and deselect any of the 99 channels to be in a bank. This is much more flexible than traditional scanners. For example, the user can form a bank composed of channels 2, 5, 31, 48, and 79.
4. Does the Priority Scan feature work like a Bearcat scanner? Well, sort of. The best way to

describe the ICOM R7000 priority algorithm is to say it resembles using a Bearcat scanner in the manual mode with the priority feature selected. One cannot "scan" more than one channel on the 7000 while sampling the priority channel. On the plus side, the priority frequency does not use up any of the 99 channels, but is programmed from the keyboard and has its own register. The user can use the "scan speed" control to set how often the priority frequency is sampled, a nice touch. In practice, the R7000 dwells on the priority frequency for a little too long, essentially chopping up the signal on the non priority frequency too much.

- 2 -

Using the internal, top-mounted speaker, the R7000 has good audio power and fidelity, better than my R71A.

The user manual is generally good, and a schematic is furnished. Some broken English makes it unclear as to whether the R7000 battery backed up RAM contains firmware as in the R71A.

There are provisions for activating a tape recorder when a signal is received, but there is about a 1 second delay in activation, causing the recorder to miss the start of the transmission. I may replace the capacitor in that relay circuit when I get the nerve to open the cabinet for the first time.

Another relay is used to switch in some filters for reception above 512 MHz, so one hears the relay clicking while scanning a mixture of low and high frequencies, a bit unnerving.

There's a lot of fun to be had with the R7000. It was interesting tuning through the link and paging signals in the 72-76 MHz band, and listening to military aircraft in the 200-400 MHz band.

My UHF antenna system consists of a government surplus

FAA discone, good for coverage between 150-1200 MHz. Although not as good as a Butternut SC3000 antenna in the 150-174 and 440-512 MHz ranges, the discone has the edge in the 225-400 and 512-1200 MHz bands. At these frequencies, a low loss feedline is very important, and I use a Belden 9913 clone made by International Wire and Cable.

- 3 -

#### COOL YOUR ICOM R7000 RECEIVER WITH ANOTHER HEAT SINK

Bob Parnass, AJ9S

The new ICOM R7000 25-2000 MHz receiver is a super radio, but the power supply tends to run hot. The two biggest heat generators are the pass transistor and bridge rectifier module. The stock heat sink, a flat piece of metal bolted to the inside of the cabinet rear, is inadequate. After 30 minutes of use, the back panel gets very hot, and the entire cabinet warms.

I added a small heat sink to the outside of my radio, using the screw that holds the bridge rectifier to the stock heat sink. An application of heat conductive grease between the added sink and the cabinet helps the heat transfer process. Now the rest of the cabinet gets barely warm to the touch.

- 4 -

#### ADD A COOLING FAN TO YOUR ICOM R-7000 RECEIVER

by Brian Kantor, WB6CYT1

In my R-7000, adding a fan makes a big difference. I've had it on continuously for three days now, and it's still nice and cool. Turns out most of the heat comes from the transformer core in the AC supply. One of those 3-1/2" 12V DC fans fits just nicely - a pair of 1/4" standoffs screwed through two of the upper back panel ventilation slots holds it in place, the power leads snake through the lower ventilation slots, and some duct tape to form a gasket, and it pulls the hot air right out. If you pick the 12V off the power supply regulator board at W3 (orange lead), it will even work properly when you run the radio off 12 volts.

[In order to blow hot air out, the fan must suck in



cool air from somewhere. Users are advised to be on guard for dust being drawn into fan-equipped R-7000s. - Editor]

- 
1. Brian Kantor, WB6CYT. University of California San Diego. ARPANET address: brian@ucsd.edu

- 5 -

#### TV INTERFACE FOR R7000

John Biro

I just got the video interface for the R7000, and to my surprise it is not an internal option. It bolts to the side of the radio (right side were the rubber feet use to mount). It is about 1 inch wide, and the same height and length as the R7000, and in a matching cabinet.

TV video is taken off the 10.7 MHz IF output jack, this presents a problem if you are using it for a Band Scope. It also "steals" the power from the IF output (the center pin of the IF out carries 12VDC so be careful not to short it out).

The interface provides RCA type jacks for both Video out and Audio out. The Video is standard levels and the Audio is low level output for input to a typical audio amp (it can not drive a speaker directly). I am not sure why the audio output is there as you can monitor the audio on the R7000, looking at the circuit they do have a sideband filter circuit so I would assume the audio is cleaner but I have not tried it and do not have any problem with the R7000 audio receiving WBFM from the TV stations.

Results: The TV-R7000 works OK, but I am just disappointed in the fact that it does not mount internally in the R7000. This could also help in its high price tag of \$119. I had a Yaesu FRG9600 with video option (only about \$30), and it worked about the same. The picture quality is good, and it is very stable. My antenna is vertically polarized, so I am working crossed polarized for TV stations but still get good results, strangely better on UHF than VHF freq. In fact, I get UHF on this set up better than my late model TV upstairs.

I think that I am most disappointed in the fact that

the unit mounts on the side of the R7000. I don't have the extra inch of bench space, so I had to put rubber feet on the unit and lay it on its side on top of the R7000. It works fine and I do not see any difference with the case of each unit tied together or not.

I made a "T" adapter and ran both the BAND-SCOPE and TV on the IF output. I have not tried to add a third option to the IF output yet but it seems to be buffered from the main IF (wide band data 9600 baud).

- 6 -

The unit comes with schematic, installation info, and cables to hook it up to a video/audio monitor. Installation is 5 minutes or less if you know where to find your screw driver the only tool required.

Now to look for some Amateur TV and for Hidden TV stations. There is more out there than featured in the TV Guide.

- 7 -

#### 198 CHANNELS FOR YOUR R7000 RECEIVER?

by Bob Parnass, AJ9S

The ICOM R7000 appears to use a uPD446C, 16K static RAM chip, for storing 99 memory channels. By looking at the pinout of this chip (IC8 on the Logic Unit) in my service manual, it appears that ICOM is only using 1/2 its memory capacity. Address lead A10 (pin 19) is soldered to a ground pad.

To double the number of memory channels in the R7000 to 198, it looks like one could "lift" pin 19 of IC8, and connect it to pin 24 (+Vcc) through a 10,000 ohm resistor. A SPST switch could be used to ground pin 19.

Another challenge would be finding a place on the R7000 to put the added "Memory Bank" switch. Perhaps one could use the Noise Blanker switch, and just leave the NB on at all times.

I don't have time to try this experiment, and would be interested in hearing results from any enterprising hobbyist willing to try this.

Long live tinkering!

[PS: Jack Albert, WA9FVP, reports that he tried the modification, and it works! Jack doesn't have the remote control option in his R7000, so he elected to use the front panel REMOTE switch as a bank switch. He installed a 48,000 ohm resistor between IC8 pin 19 and ground, and ran a wire from the REMOTE switch, through an 82,000 ohm resistor, to pin 19. When you switch between banks, you must also rotate the channel selector knob, forcing to the microprocessor to read from memory.]

- 8 -

## MODIFY YOUR ICOM R7000 TO SCAN AND SEARCH FASTER

by Bob Parnass, AJ9S

This article describes how to increase the scan and search speeds of the ICOM R7000 receiver by 60% without noticeable performance degradation.

### Background

The front panel SCAN SPEED control on the R7000 receiver allows the user to adjust the speed of scanning and searching operations, as well as the rate at which the priority channel is sampled. Rotating the control counterclockwise decreases the speed, and rotating it clockwise increases the speed.

When the SCAN SPEED control on my R7000 (serial number 001400) was turned fully clockwise, the radio would scan a maximum of about 8 channels/second, or search about 8 increments/second. As the following table shows, the stock R7000 can scan about as fast as a Radio Shack PRO-30 or PRO-2003.

TABLE 1. Maximum Scan Rates of Selected Receivers

| Scanner                         | Maximum Scan Rate<br>(channels/second) |
|---------------------------------|----------------------------------------|
| Kenwood TR-2600                 | 1.2                                    |
| Radio Shack PRO-30              | 8                                      |
| Radio Shack PRO-2003            | 8                                      |
| ICOM R7000 (stock)              | 8                                      |
| ICOM R7000 (after modification) | 13                                     |
| Regency M400                    | 13                                     |
| Bearcat 20/20                   | 15                                     |

|             |    |
|-------------|----|
| Bearcat 300 | 15 |
|-------------|----|

### R7000 Scan Circuits

The scan rate of the R7000 is determined, in part, by a simple clock outside the microprocessor. The front panel SCAN SPEED rheostat and resistor R18 (and other components in the LOGIC UNIT) control the speed of this clock. The clock output is connected to what appears to be an input port on the microprocessor. The upshot is that we can affect the scan rate without affecting

- 9 -

the other chores performed by the microprocessor.

The modification consists simply of soldering a 470,000 ohm resistor across the leads of resistor R18 on the LOGIC UNIT circuit board.

How was the value of 470,000 ohms chosen? Experimentation with different resistor values showed that for values both above and below 470,000 ohms, the R7000 scan rate decreases. Not having the R7000 Service Manual, I assume this can be explained by the firmware within the microprocessor associated with the scan rate input port.<sup>2</sup>

Adding the 470,000 ohm resistor in parallel with R18, rather than just replacing R18, has a few advantages:

1. The modification is easily undone, returning the radio to stock condition.
2. The LOGIC UNIT board does not have to be removed, as would be the case if R18 was unsoldered from the foil side.

### Making the Modification

Accessing this circuit board is not difficult, and involves the same steps used when installing the optional Remote Controller or Speech units.

Use a towel to cover your work area to avoid scratching the R7000 cabinet. Unplug the R7000 from the AC line, and turn the radio upside down. Remove the bottom cover by removing the 12 screws holding it in place.

Remove the 4 screws holding what ICOM terms the "parti-

tion panel". Pictures on pages 32 and 34 of the R7000 Instruction Manual show the partition panel. After removing this panel, the component side of the LOGIC UNIT circuit board is accessible.

- 
2. Perhaps the firmware polls the scan rate input port infrequently. Another possibility is that the scanning pulses interrupt the processor, and the interrupt firmware is limited in its ability to process frequent interrupts.

- 10 -

Locate R18, a 270,000 ohm 1/8 watt resistor, near connector J5. You may wish to remove plug P5 from J5 temporarily if it gets in your way. Carefully solder a 470,000 ohm resistor in parallel with R18. I used a 1/4 watt resistor as it was the smallest on hand.

Reassemble the radio, connect it to AC power and antenna, and enjoy.

In the modified R7000, the scan and search rates are still adjustable using the SCAN SPEED control. With the control turned fully clockwise (maximum speed), the modified R7000 scans at about 13 channels/second and won't miss weak signals.

- 11 -

A LOW COST PANADAPTOR  
FOR THE R-7000

by Bob Parnass, AJ9S

A panadaptor, or spectrum display, is a device which portrays visually the signals in a part of the radio spectrum. Panadaptors allow radio listeners to "see" activity on a portion of band without requiring the listener to tune the receiver.

They are useful for detecting the presence of spread spectrum signals or "hidden" signals riding on a sub-carrier of a main channel. Panadaptors are invaluable for detecting spurious emissions from transmitters, and unwanted products caused when 2 or more signals mix.

Panadaptors most often employ a cathode ray tube (CRT) for the display, and must be connected to the intermediate frequency (IF) amplifier stage of a receiver, at a point before filtering takes place.

The ICOM R-7000 2-2000 MHz receiver rear panel has a phono jack for wide band 10.7 MHz IF output. A DC voltage is also present at this connector and is used to power an ICOM TV accessory.

I've seen mention of 3 panadaptors for the R7000:

1. John Biro's article on retuning a Yaesu YO901 Multiscope panadaptor for 10.7 MHz, restricted bandwidth use. Selectable bandwidths of 20, 100, or 200 KHz are available.
2. The Sherwood Communications SCA-7000 signal monitor, priced at \$1600, and reviewed in May 1987 "Monitoring Times".<sup>3</sup> Bandwidth adjustable from 1 KHz - 1 MHz.
3. The Spectra-Display, priced at \$350, which requires use of an external scope.<sup>4</sup> Bandwidth

---

3. Sherwood Communications, 1310 Industrial Highway, Southampton, PA 19866. tel (215)357-9056.

4. Spectra-Display is sold by GTI Electronics, RD 1 Box 272, Lehighton, PA 18235. tel (717)386-4032.

adjustable from 200 KHz - 10 MHz. Optional preamplifier required for 12 MHz wide sweep.

In the past month, several Kenwood SM-220 monitor scope/panadaptors have appeared at hamfests selling in the \$200 to \$250 range. The Kenwood SM-220 can display transmitted or received signals. To add spectral display capability to the SM-220, one must purchase the optional BS-5 or BS-8 module, which consist of a printed circuit board, a steel enclosure, interconnecting cables, and a new graticule. The panadaptor module mounts inside the SM-220 cabinet.

The BS-5 is used with the TS520 and TS530 transceivers, which have an IF of 3.395 MHz. The BS-8 is used with the TS820 and TS830 transceivers, which have an IF of 8.830 MHz. Since the IF of the ICOM R7000 is 10.7 MHz,

one must alter the panadaptor circuitry to accept 10.7 MHz input.

If you have any choice in the matter, get the BS-8, as it requires fewer changes than the BS-5, and may even require no changes at all!

The panadaptor module circuit consists of several stages, but only two are directly related to the IF frequency:

1. A crystal oscillator is used as a marker generator.
2. A voltage tuned oscillator is swept across the IF of the receiver, and employs a varicap diode, an inductor and capacitors.

The marker generator is not vital for panadaptor operation. It merely provides a single "pip" that one may use to center the display on the CRT screen, and is similar in purpose to the crystal calibrator in older receivers.

The marker generator circuits in the BS-5 and BS-8 are identical except for one crystal. One need only replace the 3.395 MHz crystal (in the BS-5), or 8.830 MHz crystal (in the BS-8) with a 10.7 MHz crystal to adapt the SM-220 marker to 10.7 MHz IF. I did not alter this stage, although I would if I had a 10.7 MHz crystal handy.

The voltage tuned oscillator is the stage that deserves our attention. The changes required depend on whether

- 13 -

you have the BS-5 or BS-8 panadaptor module.

#### Changes for BS-5 Module

Change the following capacitors:

1. C231 from 1000 pf to 68 pf.
2. C232 from .01 uf to 1000 pf. (You can use the capacitor which used to be C231.)
3. C234 from 100 pf to 22 pf.
4. C236 from 47 pf to 22 pf.
5. C237 from 680 pf to 100 pf. (You can use the

capacitor which used to be C234.)

Solder a 10 microhenry inductor in parallel with L204, a 20 microhenry inductor.

#### Changes for BS-8 Module

I haven't tried the BS-8 module, but encourage you to try using it as is, without modification unless necessary.

These steps are needed only if you cannot find settings of the side mounted alignment controls that get the display to behave as specified in the owner's manual:

1. Remove C233, the 33 pf disc capacitor, from the printed circuit board.
2. Replace coil L204, the 4.7 microhenry inductor, with a 6 or 7 microhenry inductor.

#### Alignment

Follow the alignment procedure in the SM-220 owner's manual to adjust the panadapter. This consists of adjusting 2 potentiometers and 1 trimmer capacitor through holes thoughtfully provided in the side of the cabinet.

The alignment instructions rely on the use of the internal Marker Generator to generate a signal at the center of the passband. If you haven't converted the

- 14 -

Marker Generator circuit, you can tune your receiver to a frequency with a signal present at a known frequency (like 162.550 MHz - the National Weather Service), and use that as a frequency standard.

Most of the time spent in alignment will be in alternate adjustments between the trimmer capacitor and the wide band sweep potentiometer, which interact with each other.

#### Wider Bandwidth

The SCAN WIDTH switch on the stock SM-220 can be set to display a 40 KHz or a 200 KHz wide picture. I adjusted my modified SM-220 to display a 100 KHz or a 500 KHz wide picture. By adjusting the controls on the side of



the SM-220, wider bandwidths are possible, but wider bandwidths make it more difficult to resolve individual signals close to each other in frequency. As the bandwidth gets wider, the horizontal sweep loses linearity, causing the graticule calibration lines to be inaccurate.

#### Connection to R-7000

As mentioned earlier, a DC voltage is present at the R-7000 IF output connector and is used to power an ICOM TV accessory. A direct connection between the R-7000 IF output connector and SM-220 would damage at least one of these units.

To block the DC voltage, a 0.1 microfarad capacitor was soldered inside the R-7000, between the IF output jack and the adjacent jack labeled "spare". Connection between the R-7000 and SM-220 is then made using a short length of RG-58/U coaxial cable, with one end plugged into the R-7000 "spare" jack, and the other end plugged into the rear of the SM-220.

This leaves the original IF output jack undisturbed so it can be used with the TV adaptor accessory.

#### Vertical Sensitivity

When I connected my modified SM-220 to my R7000, the SM-220 would display only the strongest of signals. To improve the display sensitivity, I inserted a 20 dB gain RF amplifier between the R7000 and SM-220. The

- 15 -

amplifier was a spare Ameco PLF2 FET receiver preamp, adjusted for 10.7 MHz, but other amplifiers can be used, provided they have at least a 500 KHz bandwidth, and sufficient gain, at 10.7 MHz.

#### False Readings - Images

The SM-220 circuit is like a superheterodyne receiver. The panadaptor itself has a 455 KHz IF, and like other superheterodyne receivers with a low IF frequency, is prone to images.

An image is manifested as a false pip, which moves across the screen as the receiver is tuned, and is 910 KHz (twice the IF) away from the actual signal.

The images discussed here are in the SM-220, not in the receiver. Images are bothersome on the strongest signals, like those 300 watt paging transmitters that saturate the county with RF, belching out strange digital noises or voices (now illegal to monitor).

#### Use With Other Receivers

The modified SM-220 can be used with other receivers having a 10.7 MHz IF. In other receivers, one would need to find the proper point in the IF stage (before filtering takes place), install a connector, then wire a DC blocking capacitor between the IF stage and connector.

=====  
===  
Bob Parnass AJ9S, AT&T Bell Laboratories - att!ihuxz!parnass - (312)979-5414



From: georgez@synopsys.com (George Z)  
Newsgroups: comp.archives  
Subject: [rec.radio.amateur.misc] Radio Mods  
Message-ID: <1991Aug11.083643.17874@agate.berkeley.edu>  
Followup-To: rec.radio.amateur.misc  
X-Original-Date: 5 Aug 91 17: 58:02 GMT  
X-Original-Newsgroups: rec.radio.amateur.misc

Archive-name: auto/rec.radio.amateur.misc/Radio-Mods  
Original-posting-by: georgez@synopsys.com (George Z)  
Original-subject: Radio Mods  
Reposted-by: adam@soda.berkeley.edu

In response to my posting of last week regarding the radio mods info, I have the following information:

PCSERVER -- An email server for MS-DOS.

Available Commands:

=====

|                         |                                                                                            |
|-------------------------|--------------------------------------------------------------------------------------------|
| SENDME <filename>       | Requests a file from the server.                                                           |
| SENDME <filename> \$HEX | Requests a file and the server will send it as Hex.                                        |
| GET <filename>          | Same as SENDME.                                                                            |
| DIR <options>           | Sends a list of files in the current directory.<br>DIR *.*      DIR *.EXE      DIR *.MOD   |
| CD <options>            | Changes the default directory.                                                             |
| VERSION                 | Displays the current version of PCSERVER with some statistics on the installation and use. |

All commands must start at the first position on the line. The server ignores the subject line in the header of the message. Only commands in the body of the message will be considered.

Example:

If you wanted to request the file called TS440.MOD from the MODS directory, you would send the following commands in your mail message:

```
CD MODS
SENDME TS440.MOD
```

This will cause two mail messages to be generated. The first message would notify you that the "CD MODS" was taken ok; the second message would contain the file TS440.MOD.

The files are also available through anonymous FTP to 129.100.22.100

Any questions can be directed to:

Mark Bramwell,  
The University of Western Ontario  
School of Business Administration,

mbramwel@novell.business.uwo.ca

---

Well, thats all for now, I hope you all find this usefil...

Thanks for your interest and help.

'73 de George KJ6VU

.



Article 40146 of rec.radio.amateur.misc:  
Newsgroups: rec.radio.amateur.misc  
Path: west.West.Sun.COM!news2me.EBay.Sun.COM!sun-barr!cs.utexas.edu!swrinde!  
emory!kd4nc!n4tii  
From: n4tii@kd4nc.uucp (John Reed)  
Subject: Mods for RCI-2950  
Message-ID: <1993May20.195809.24314@kd4nc.uucp>  
Organization: KD4NC HAM Packet Radio Gateway  
References: <1tfkd2INN7dl@uwm.edu>  
Date: Thu, 20 May 1993 19:58:09 GMT  
Lines: 111

erchul@csd4.csd.uwm.edu (David A. V. Erchul) writes:

>

> Now that I have decided to get a RCI 2950  
> (Thanks Nick, Robert, John & haga?)

> Would some kind soul PLEASE mail/post  
> any/all mods for the RCI 2950.

> Thanks  
> Dave

OK.....here they go...

Subj: Ranger 2950 mods

Someone here recently posted a message asking for available mods  
for the Ranger RCI-2950 10 meter radio. Here's what I have.

#### Frequency Modification

1. Remove the case. I \*think\* you can remove either the top cover  
or the bottom cover to get to the PC board with the jumpers.  
It will be a small PC board immediately behind the front panel.
2. Locate "J2". There will be a jumper on pins P3 and P4.
3. Remove this jumper to expand coverage to 26 MHz - 29.7 MHz.
4. Move the jumper from P3-P4 to P1-P2 to expand coverage to  
26 MHz - 32 MHz.
5. After moving (or removing) the jumper, press the CPU reset button  
(located below J2).

NOTE: Operation between 30-32MHz may require retuning the VCO.

#### CB Channel Readout Modification

1. Locate J1. There will be a jumper on pins P1-P2.
2. Remove jumper and place on P2-P3.
3. Press the LOCK button on the front panel. The readout will now  
display the CB channel number 1-40 -- also will display "A" channels.
4. Press LOCK again to return to VFO mode.

NOTE: The SHF button will not operate while in CB mode.

This modification will disable the frequency lock function.

CB Channel 9 Select Modification

1. Locate J3. There is a jumper between P1-P2.
  2. Remove the jumper and place it on P2-P3.
  3. Press the "roger beep" button to go directly to CB Channel 9.
- NOTE: Doing this modification makes it impossible to turn off the roger beep feature (unless, \*possibly\* you make sure the roger beep is turned off before moving the jumper. I'm not sure).

---

"Tuneup" Modifications

Adjust VR14 (AMC) for maximum forward modification. Mod limiter Q32 can be removed for more modulation, but it also disables VR12 (SSB ALC) and disables variable power for SSB. I do not recommend removing Q32; you'll have plenty of modulation as is.

Tune L34, L13, L14, L46 and L10 in AM mode for maximum forward swing, using a peak-reading wattmeter. Try to balance for even power from top to bottom of frequency range.

NOTE: You'll have a LOT of trouble identifying these cans. Sorry, I don't know for sure where they are either.

Adjust VR13 (AM High Power) for 12 watts dead key with the front panel RF power control at maximum. Adjust VR15 (AM Low Power) for 2 watts dead key with front panel RF power control at minimum. From the 12-watt dead key you should see a forward swing of 30-40 watts. From the 2-watt dead key you should see a forward swing of 18-20 watts.

Adjust VR12 (SSB High Power ALC) for maximum PEP on SSB, then back off just a little, with front panel RF power control at maximum. Adjust VR16 (SSB Low Power ALC) for 5-6 watts PEP on SSB with front panel RF power control at minimum. You should see 40-50 watts PEP on SSB with front panel RF power control at maximum.

---

Microphone wiring diagram

Pin 1 -- shield  
Pin 2 -- Audio  
Pin 3 -- Transmit  
Pin 4 -- Receive  
Pin 5 -- Frequency select up            These might be reversed.  
Pin 6 -- Frequency select down /

---

Disclaimer:

The preceding message is posted for information only. I do not condone the modification of amateur transceivers for use outside the amateur band. It is \*possible\* that performing the tune-up modifications will shorten the life of the radio's components due to driving them too close to their design tolerances. I accept no responsibility for possible damage to any radio that is modified in this way. I cannot personally vouch for any of these modifications; they were given to me by a technically-inclined friend.

---

--- GEcho/beta



\*\*\*\*\*

I hope those help....I assume no liability for the above mods...I got them off some BBS somewhere and just merely passing them along...

(I'm pretty sure they work...no CB bootleggin' there good buddy!)

John

n4tii%kd4nc.uucp@gatech.edu



Newsgroups: rec.radio.amateur.misc  
From: n4tii@kd4nc.uucp (John Reed)  
Subject: Re: Mods for RCI-2950  
Message-ID: <1993May20.195809.24314@kd4nc.uucp>  
Organization: KD4NC HAM Packet Radio Gateway  
References: <1tfkd2INN7dl@uwm.edu>  
Date: Thu, 20 May 1993 19:58:09 GMT  
Lines: 90

Subj: Ranger 2950 mods

Someone here recently posted a message asking for available mods for the Ranger RCI-2950 10 meter radio. Here's what I have.

#### Frequency Modification

1. Remove the case. I \*think\* you can remove either the top cover or the bottom cover to get to the PC board with the jumpers. It will be a small PC board immediately behind the front panel.
2. Locate "J2". There will be a jumper on pins P3 and P4.
3. Remove this jumper to expand coverage to 26 MHz - 29.7 MHz.
4. Move the jumper from P3-P4 to P1-P2 to expand coverage to 26 MHz - 32 MHz.
5. After moving (or removing) the jumper, press the CPU reset button (located below J2).

NOTE: Operation between 30-32MHz may require retuning the VCO.

#### CB Channel Readout Modification

1. Locate J1. There will be a jumper on pins P1-P2.
2. Remove jumper and place on P2-P3.
3. Press the LOCK button on the front panel. The readout will now display the CB channel number 1-40 -- also will display "A" channels.
4. Press LOCK again to return to VFO mode.

NOTE: The SHF button will not operate while in CB mode.

This modification will disable the frequency lock function.

#### CB Channel 9 Select Modification

1. Locate J3. There is a jumper between P1-P2.
  2. Remove the jumper and place it on P2-P3.
  3. Press the "roger beep" button to go directly to CB Channel 9.
- NOTE: Doing this modification makes it impossible to turn off the roger beep feature (unless, \*possibly\* you make sure the roger beep is turned off before moving the jumper. I'm not sure).

---

#### "Tuneup" Modifications

Adjust VR14 (AMC) for maximum forward modification. Mod limiter Q32 can be removed for more modulation, but it also disables VR12 (SSB ALC) and disables variable power for SSB. I do not recommend removing Q32; you'll have plenty of modulation as is.

Tune L34, L13, L14, L46 and L10 in AM mode for maximum forward swing, using a peak-reading wattmeter. Try to balance for even power from top to bottom of frequency range.

NOTE: You'll have a LOT of trouble identifying these cans. Sorry,

I don't know for sure where they are either.

Adjust VR13 (AM High Power) for 12 watts dead key with the front panel RF power control at maximum. Adjust VR15 (AM Low Power) for 2 watts dead key with front panel RF power control at minimum.  
>From the 12-watt dead key you should see a forward swing of 30-40 watts.  
>From the 2-watt dead key you should see a forward swing of 18-20 watts.

Adjust VR12 (SSB High Power ALC) for maximum PEP on SSB, then back off just a little, with front panel RF power control at maximum. Adjust VR16 (SSB Low Power ALC) for 5-6 watts PEP on SSB with front panel RF power control at minimum. You should see 40-50 watts PEP on SSB with front panel RF power control at maximum.

---

Microphone wiring diagram

Pin 1 -- shield  
Pin 2 -- Audio  
Pin 3 -- Transmit  
Pin 4 -- Receive  
Pin 5 -- Frequency select up            These might be reversed.  
Pin 6 -- Frequency select down /

---

Disclaimer:

The preceding message is posted for information only. I do not condone the modification of amateur transceivers for use outside the amateur band. It is \*possible\* that performing the tune-up modifications will shorten the life of the radio's components due to driving them too close to their design tolerances. I accept no responsibility for possible damage to any radio that is modified in this way. I cannot personally vouch for any of these modifications; they were given to me by a technically-inclined friend.

---

--- GEcho/beta

\*\*\*\*\*

I hope those help....I assume no liability for the above mods...I got them off some BBS somewhere and just merely passing them along...

(I'm pretty sure they work...no CB bootleggin' there good buddy!)

John  
n4tii%kd4nc.uucp@gatech.edu



Subject: Squelch Improvements for Scanners

IMPROVE THE SQUELCH IN YOUR MONITOR RECEIVER

by Bob Parnass, AJ9S

The squelch control in some FM monitor receivers is difficult to use because of too much hysteresis. The American Heritage Dictionary of the English Language defines hysteresis as the:

- o "Failure of a property changed by an external agent to return to its original value when the cause of the change is removed."

It's like having play in a car's steering wheel, or backlash in a gear set. Too much hysteresis in a squelch circuit forces one to keep the squelch at a tighter setting, missing weaker signals when scanning or searching. The squelch hysteresis problem was first addressed in a 1984 article about the Radio Shack PRO-24 crystal controlled scanner.<sup>1</sup>

Why do engineers design these circuits with any hysteresis? Basically, hysteresis prevents weak signals from "popping" the squelch open and closed rapidly, which would be very annoying to the listener. A squelch circuit with hysteresis requires a stronger signal to open the squelch than it does to keep it open.

Models cursed with too much hysteresis include the Bearcat 800XLT2, Radio Shack PRO-2003, PRO-20043, and others. Don't despair, the fix is simple for most radios. Unfortunately, the Uniden/Bearcat 600XLT and 760XLT series use tiny surface mount components, which makes modification very difficult. I've successfully reduced the squelch hysteresis on other models by replacing a single resistor.

- 
1. "The Radio Shack PRO-24 Scanner," by Bob Parnass, excerpted in the "Technical Topics" column, RCMA Newsletter, February 1984.
  2. "The Bearcat 800XLT ... an Owner's Report," by Bob Parnass, in Monitoring Times, March 1986.
  3. "Product Review: The Radio Shack PRO-2004 Programmable Scanner," by Bob Parnass AJ9S, in The Radio Enthusiast, February 1987, and Monitoring Times, March 1987.

Hysteresis is usually implemented by providing feedback from the squelch gate input to output, through a resistor. The higher the resistor value, the less feedback there is, and less hysteresis. My modification involves replacing the "stock" resistor with a higher value resistor, as identified in the table below.

This article cannot provide step-by-step instructions for each radio. I always encourage radio hobbyists to purchase the service manuals for their equipment. The most useful sections of the manual are the schematics and printed circuit diagrams. Good manuals will also describe the theory of operation and alignment procedures, and contain a complete parts list.

If your radio has too much hysteresis, and is not listed in the table, study the service manual. Motorola MC3357 and MC3359 integrated circuits, which contain IF and squelch circuitry, are popular in scanners. In these receivers, look for the hysteresis resistor to be connected to these ICs.

NOTES:

1. The author cannot furnish modification information for other radios.
2. Don't attempt this, or any other internal modification, unless you are skilled in electronic servicing.
3. Make sure your receiver is disconnected from any power source before opening the cabinet.

| Squelch Hysteresis Resistor In Selected Receivers |                      |               |                                                                                                |
|---------------------------------------------------|----------------------|---------------|------------------------------------------------------------------------------------------------|
| Receiver Model                                    | Resistor Designation | Factory Value | Comments                                                                                       |
| Radio Shack PRO-24                                | R35                  | 33K           | replace with 220K.<br>Located between pins 12 and 14 of MC3357 (IC1)                           |
| Radio Shack PRO-2002                              | R197                 | 47K           | try 220K.                                                                                      |
| Radio Shack PRO-2004                              | R148                 | 47K           | remove R148<br>or replace with 220K.<br>On linear board, between pins 12 & 14 of TK10420 (IC2) |
| Bearcat 220                                       | R75                  | 2.7M          | may be ok as is                                                                                |
| Bearcat 20/20                                     | R75                  | 2.7M          | may be ok as is                                                                                |
| Bearcat 250                                       | R66                  | 2.2M          | may be ok as is                                                                                |
| Uniden/Bearcat 800XLT                             | R91                  | 860K          | replace with 2.2M.<br>Located on pin 14 of MC3359P IC                                          |
| Plectron P1                                       | R81                  | 180K          | may be ok as is                                                                                |
| Plectron 700                                      | R96                  | 180K          | replace with 560K                                                                              |







Subject: Sony 2010 repair/mod

HOW TO DETECT AND REPAIR THE  
COMMONLY BLOWN TRANSISTOR IN THE SONY 2010

Michael Covington, N4TMI

(Free distribution; you are welcome to copy and distribute  
this document.)

As is well known, transistor Q303 in the front-end of the Sony ICF-2010  
general coverage receiver is easily damaged by static electricity.  
Here is information on how to diagnose and fix this problem.

WHAT ARE THE SYMPTOMS?

A 10- to 20-dB loss of sensitivity on AM (longwave, medium wave, short  
wave). If you have a good antenna you may not even notice the loss.  
In all other respects the radio functions normally.

HOW DO I TEST IT?

If you buy a used 2010 it's a good idea to perform this test even if you  
do not notice a performance problem.

Remove the back cover and locate transistor Q303, near the antenna input.  
Identify its three terminals (D, G, and S).

Now measure the voltage from each of those terminals to ground, with the  
receiver turned on and receiving shortwave. (A convenient ground connec-  
tion is the outer part of the antenna jack.)

The voltages should be: S 0.2V G 0.0 V D 2.9 V

Note especially the drain (D) voltage. If it is substantially lower than  
2.9V, the transistor is leaky. (Mine measured 1.6V when defective.)  
If it's substantially higher (like 4.5V), the transistor is open.

HOW DO I FIX IT?

The popular MPF-102 transistor, available at Radio Shack, is a suitable  
replacement. (Sony used a 2SK152, not widely available in the U.S.A.)  
Simply unsolder the old transistor and install the new one, then check  
voltages again. No alignment is necessary.

HOW DO I PREVENT FURTHER TROUBLE?

By connecting the shortwave antenna through a protective diode network,  
as shown below.

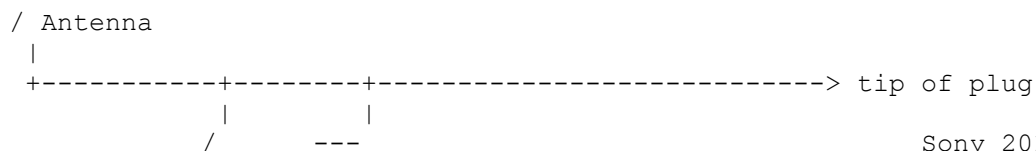

Sony 2010

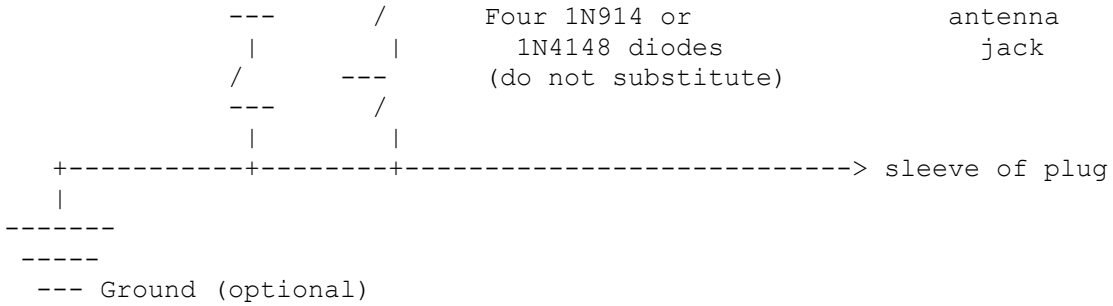

The diodes limit all voltages going into the receiver. Use the specified types; other kinds would produce loss of signal, signal mixing (resulting in image frequencies), or both.

The 2010 has a built-in protective diode network connected to the built-in telescoping antenna but not the antenna jack.

--

```

=====
Michael A. Covington, Ph.D. | mcovingt@uga.cc.uga.edu | ham radio N4TMI
Artificial Intelligence Programs | U of Georgia | Athens, GA 30602 U.S.A.
=====

```



From : KC6HPN @ WB6YMH.#SOCA.CA.USA.NA  
To : 9600 @ ALLUS  
Date : 920426/2249  
Subject: TAPR 9600 MODEM MODS PART 1  
Path : K6VE!WB6YMH

From: KC6HPN @ WB6YMH.#SOCA.CA

TAPR FULL-DUPLEX (NEW) 9600 BAUD MODEM MODS BY KC6HPN (PART 1 OF 4)  
APRIL 23, 1992

These modifications correct several problems that can seriously degrade the performance of the new (not the K9NG) TAPR 9600 baud modem. They have significantly improved the usability of my modem. DCD (Data Carrier Detect) operation, in particular, went from intermittent to rock solid. All mods have been implemented on my (first production run) TAPR modem board, which is installed in a PK232MBX.

I welcome any comments and will answer any questions on these modifications. Just drop a message in my BBS mailbox, KC6HPN @ WB6YMH.#SOCAL.CA.USA.NA.

73, Brian, KC6HPN

#### MODULATOR SIDE MODIFICATION:

1. HOW: Remove capacitor C5 (0.001 uf).

WHY: Op-amps tend to oscillate when driving a non-isolated capacitive load to ground. U22B, a TLC274 op-amp is driving C5 to ground through C31. U22B may oscillate at approximately 400 kHz due to the pole created by C5. This oscillation will be superimposed on the modulating waveform. To diagnose this problem, examine the eye pattern at TXA. The eye should be sharp, if it is fuzzy, the op-amp is oscillating.

NOTE: C5 normally functions as part of an RFI filter to prevent noise from entering the modem via the TXA line. I have found that in my situation C2 and R2 alone are sufficient. Those with RFI problems should not remove C5. Instead, place a 220 to 470 ohm resistor in series with C31 to provide resistive isolation from C5. This resistor will cause a slight loss in output drive. If necessary, you may increase output drive by changing R39 to 300 k.

NOTE: The first TAPR kits used a TL084 op-amp for U22 which may be slightly more resistant to oscillation. However, the TL084 may still oscillate.

#### DEMODULATOR SIDE MODIFICATION:

1. HOW: Change U4 from a TL084 to a TLC274 op-amp.  
Replace D2 (1N4148) with a germanium diode (Bvr > 15 volts)  
or if not available with a 1N3600 silicon diode.

WHY: Noise margin. The data slicer output is extremely dirty. An increase in noise margin represents improved bit recovery performance.

The TLC274 can pull its output nearly to ground, the TL084 cannot. This

becomes important in U4A, where the op-amp is used as a schmitt-trigger comparator (data slicer). The op-amp output drives a digital input to ground through diode D2. D2, a 1N4148, adds 0.9 volts offset from ground, and a TL084 will add from 0.5 to 0.8 volts to this offset. Since a 74HCxx series part must see less than 1.4 volts (VCC=5.0 v) to sense a logic 0, the resulting noise margin may be as low as  $1.4 - (0.8 + 0.9) = -0.3$  volts. This will cause bit recovery errors and intermittent dropout of DCD (i.e. many retries) With the TLC274 and 1N3600, noise margin is  $1.4 - (0.05 + 0.6) = 0.75$  volts - much better-. Germanium diodes, now somewhat rare, add only 0.35 volts offset and will boost noise margin even further to about 1.0 volts.

A trade off is that the TL084 slew rate is twice as fast as the TLC274, making it a faster comparator. However, increased noise margin seems to be the critical item in my modem.

CONTINUED IN PART 2 OF 4 ...

From : KC6HPN @ WB6YMH.#SOCA.CA.USA.NA  
To : 9600 @ ALLUS  
Date : 920426/2231  
Subject : 9600 MODS PART 2 OF 4  
Path : K6VE!WB6YMH

From: KC6HPN @ WB6YMH.#SOCA.CA

TAPR FULL-DUPLEX (NEW) 9600 BAUD MODEM MODS BY KC6HPN (PART 2 OF 4)

2. HOW: Remove capacitor C24 (330 pf) and replace resistor R34 (2.2 k) with a wire (zero ohm) jumper -BUT ONLY IF YOU PUT IN MOD#3 -

WHY: Capacitance and series resistance are the kiss of death to digital circuits. Unless U19F is a schmitt-triggered gate, such as the 74HC14, (which it is not), its output will glitch due to the slow risetime of the input waveform. Since U19F is in the data path, this will cause an increase in bit errors, even when the modem is receiving a strong, well formed signal. Ironically, the RC circuit formed by R34 and C24 may have been intended to filter out glitches from the bit recovery circuit (U7B, U11D) which has problems of its own (see mod#3). Or it may have been intended to solve a critical race condition by providing an RC delay (never use an RC for this...use a flip-flop instead). In the case of my modem, removing this circuit once mod#3 was made improved performance.

3. Okay, the easy part is over. This mod is the most critical and the most difficult. I'm also going to do "WHY" first this time, and "HOW" later.

WHY: It is very, very necessary to add a double-buffering circuit directly after the data slicer (U4A, D2). A double buffer circuit consists of two flip-flops connected in SERIES and operated off of the same clock (fig.1). Its purpose is to synchronize external, asynchronous, signals to an internal clock without causing glitches.

+5 v

┌

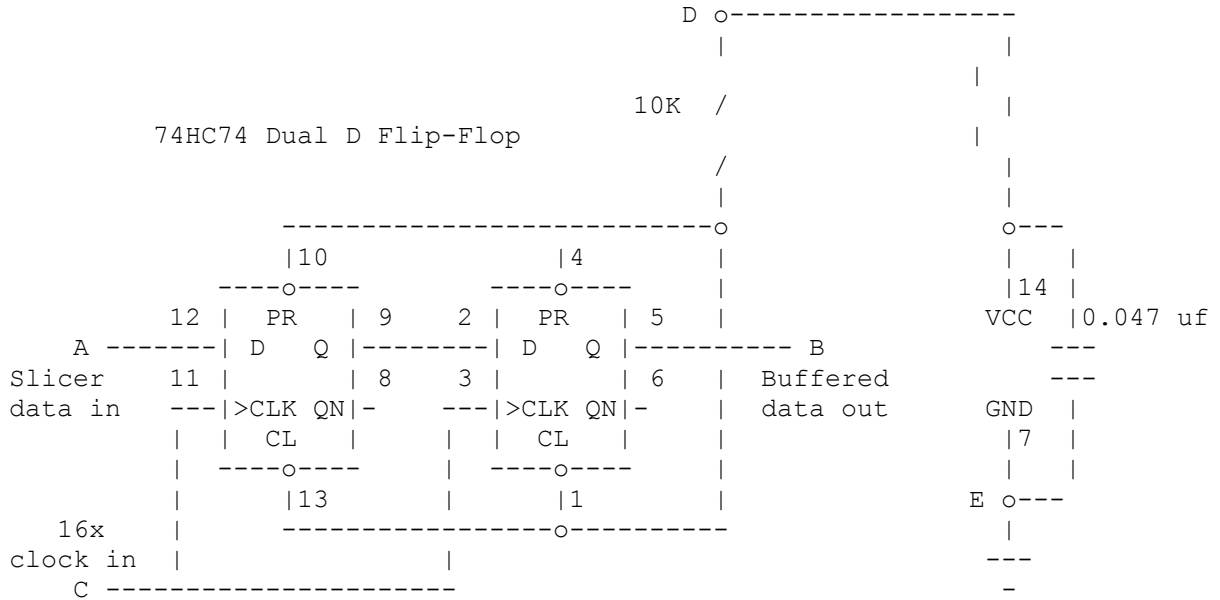

Figure 1: DOUBLE BUFFER CIRCUIT

CONTINUED IN PART 3 OF 4 ...

From : KC6HPN @ WB6YMH.#SOCA.CA.USA.NA  
 To : 9600 @ ALLUS  
 Date : 920426/2234  
 Subject : 9600 MODS PART 3 OF 4  
 Path : K6VE!WB6YMH

From: KC6HPN @ WB6YMH.#SOCA.CA

TAPR FULL-DUPLEX (NEW) 9600 BAUD MODEM MODS BY KC6HPN (PART 3 OF 4)

If the input signal to a flip-flop is in transition when the flip-flop is clocked, the flip-flop will briefly become metastable. That is, its output will hover between logic 0 and logic 1. In a short period, the flip-flop will resolve the metastable state and settle to a 1 or a 0. Two identical flip-flops connected to in PARALLEL to the same asynchronous input (as are U7B and U16) may not only produce glitches on their outputs, but will often settle to DIFFERENT logic states. Ooops! Half the modem thinks it sees the bit, half doesn't. This causes bit errors and faulty DCD.

What the double-buffer does is this: 1. On the first clock edge, the first flip-flop clocks in the asynchronous data and resolves the metastable state. 2. On the second clock, the second flip-flop clocks in the settled data and provides a stable, glitch-free output. Propagation delay and setup and hold time requirements prevent the two flip-flops from clocking the glitchy data straight through, even though they are using the same clock edge.

A deglitched, synchronous output is then passed to U16 for DCD and bit clock generation, and to U7B for bit recovery. Glitches formerly generated in U7B by metastability and passed to U19F through U11D are eliminated, removing the



need for a (bad) glitch filter formed by R34 and C24.

This circuit improved both DCD reliability and data recovery considerably on my modem. If your DCD indicator (on the modem) flickers even during a strong signal and you get many retries, this circuit will help.

HOW: The general method is to construct a circuit assembly using an IC socket and mount the assembly "dead bug" style (upside-down) in the vacant U6 space. If you are using the optional internal clock generator and U6 is present, use any other convenient location. Once assembled and connected, the assembly is secured to the modem PC board by double-backed tape.

(A) Obtain a 14-pin PC mount IC socket, preferably with an integral VCC decoupling capacitor, such as those made by AUGAT. Turn the socket over. Using fine insulated wire or resistor lead stubs, etc., construct the assembly as follows:

- I. Wire pins 1, 4, 10, and 13 together
- II. Wire pins 3 and 11 together
- III. Wire pins 2 and 9 together
- IV. Solder a 10k resistor between pins 1 and 14
- V. If you are not using a decoupled socket, solder a 0.047 uf capacitor between pins 14 and 7

(B) Once the assembly is completed, place it to one side and examine the modem board. Using a soldering iron and tweezers, lift the non-banded end of diode D2 clear of its mounting hole. Next, using the same procedure, lift the end of R19 nearest to U5, the 7805 voltage regulator. Bend the hanging ends of D2 and R19 together so that they touch.

(C) Using thin, flexible wire, connect point A (pin 12) on the double buffer assembly to the joined ends of D2 and R19. Secure with solder

(D) Using thin, flexible wire, connect point B (pin 5) on the double buffer assembly to the mounting hole vacated by R19. The area around the empty R19 hole is crowded, so solder carefully.

CONTINUED IN PART 4 OF 4 ...

From : KC6HPN @ WB6YMH.#SOCA.CA.USA.NA  
To : 9600 @ ALLUS  
Date : 920426/2236  
Subject : 9600 MODS PART 4 OF 4  
Path : K6VE!WB6YMH

From: KC6HPN @ WB6YMH.#SOCA.CA

TAPR FULL-DUPLEX (NEW) 9600 BAUD MODEM MODS BY KC6HPN (PART 4 OF 4)

(E) Solder one end of a thin, flexible wire to U18, pin 11 on the back side of the modem board. Bring the end of the wire up and around to the top of the board, routing it alongside U18. Connect the wire to point C (pin 11) on the double buffer assembly.

(F) Next, connect a wire to point E (pin 7), ground, of the double buffer

assembly. Solder the other end of the wire to the center pin of U5, the 7805 voltage regulator.

(G) Connect a wire to point D (pin 14), +5 volts, of the double buffer assembly. Solder the other end of the wire to the pin of U5 furthest from the modem PC board edge.

(H) Carefully turn the assembly upright and insert a 74HC74 dual D flip-flop IC into the socket. Make sure the notch on the IC is on the same side as the notch on the socket.

(I) Apply a thin strip of double-backed tape to the IC, invert the IC and assembly and stick it to the modem PC board in the unused U6 location.

(J) Carefully power up the TNC and check for normal operation.

HINTS: Use heat shrink tubing wherever possible to minimize exposed connections. Carefully premeasure all wire lengths before soldering. Wires to the assembly should be long enough to allow access to the IC, for insertion and removal, but no longer.

- END OF TAPR MODEM MODS FILE -



Subject: TNC2 Duplex Mod

I thought I would pass along a fix for a problem that has been cropping up more and more across the country with packet on full duplex machines.

It would appear that a lot of synthesized radios wander in transmit frequency when the first key up. If your located in a crowded repeater area there is a very good chance your keying up a repeater that might be within 50Khz of your transmitting frequency, on the input of repeaters. Especially bad is the ICOM 2AT. We have spoken with ICOM about this problem and they are working on it.

There is a simple fix for folks running MFJ TNC's or TNC2 hardware clones. This does not include the Pac-Comm Tiny 2's or their latest TNC's on the market. It must be a TNC2 hardware compatible clone, such as the MFJ TNC's.

The fix involves soldering a 4.7uf tantalum cap across R44 with the positive side towards Q8, or the junction of R44 and R45. This will give you around 500ms delay of audio on the XR2206 chip, while allowing your radio to key up immediately, without tones for 500ms. After you make the mod, you will need to increase your Txdelay anywhere between 10-20 over what your using as a default now. Some experimenting with the Txdelay is require to get things adjusted correctly.

Hope this mod will help users out there, and I'd appreciate a note back to anyone trying this and finds it fixing this problem. It has cured our problem in this area. You may wish to post this as a bulletin for users to try out and circulate it to other BBS's.

73, Steve N7HFZ @ N7HFZ  
NAPRA Technical V.P



Date: 2 May 88 15:22:00 GMT

Posted by: silver!commgrp@iuvox.cs.indiana.edu

Subject: Kenwood TH-215A modification

KENWOOD TH-215A handheld transceiver out-of-band modification:

1. Remove two screws from belt clip
2. Remove 4 screws from back of radio
3. Slide front assembly off
4. Locate set of 4 jumpers:

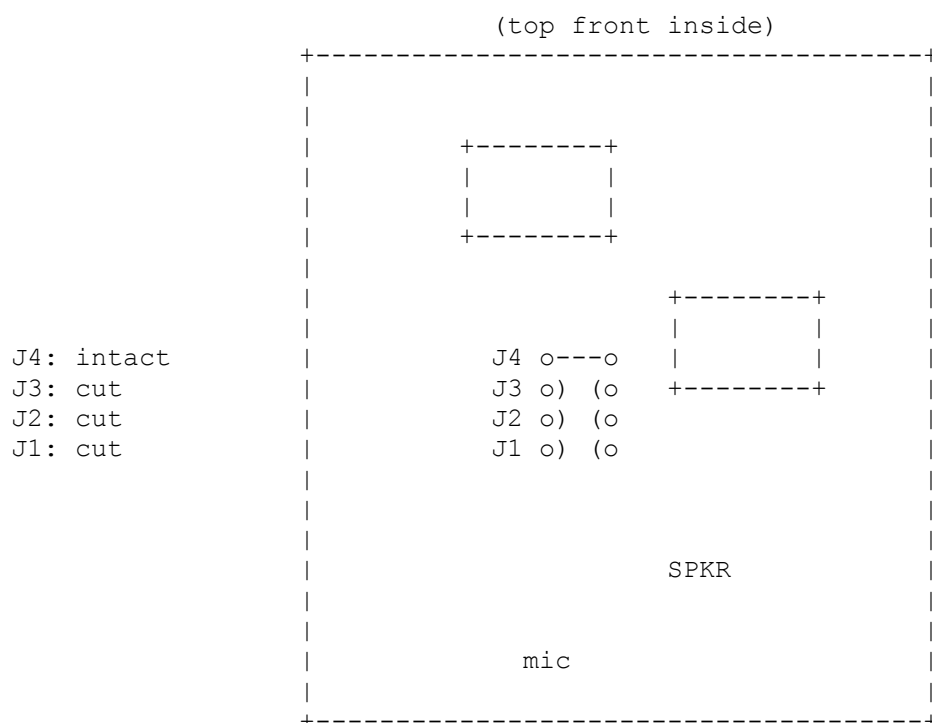

5. Reassemble radio.
6. Reset microprocessor: Turn radio on while simultaneously pressing both F key and ENTER key.

--

DISCLAIMER: I do not own a TH-215A and have not verified the above information. Hopefully, the modified frequency range includes 162 MHz weather-broadcast freqs. Remember, it is ILLEGAL to transmit outside the ham band with non-FCC-type-accepted equipment, even if you are licensed to use such frequencies.



From: jkesling@cup.portal.com (John Darrell Kesling)  
Subject: Re: Kenwood TH225A modifications wanted  
Date: 23 Oct 91 06:22:02 GMT  
Organization: The Portal System (TM)  
Lines: 60

The TH-251A is very similar to the TH-225A. The following TH-215A mod has been tested on the TH-225A and seems to work, thanks Steve (W9OMX). All the standard disclaimers apply, use at your own risk, etc.

73's  
John - WA8ZGO - jkesling@cup.portal.com

----- cut here -----

Date: 2 May 88 15:22:00 GMT  
Posted by: silver!commgrp@iuvox.cs.indiana.edu  
>Subject: Kenwood TH-215A modification

KENWOOD TH-215A handheld transceiver out-of-band modification:

1. Remove two screws from belt clip
2. Remove 4 screws from back of radio
3. Slide front assembly off
4. Locate set of 4 jumpers:

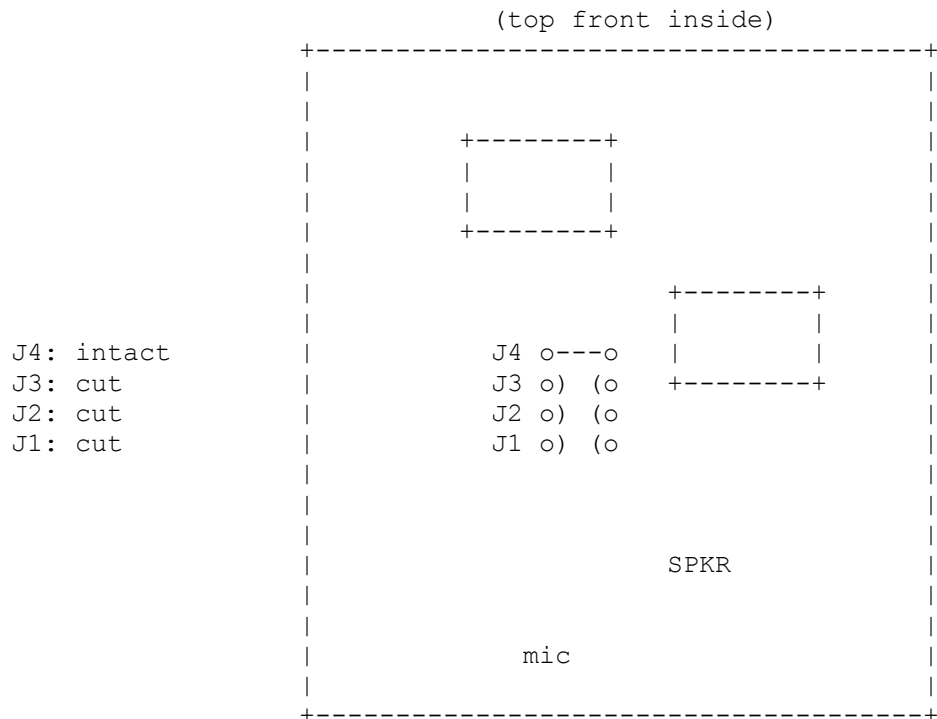

5. Reassemble radio.



6. Reset microprocessor: Turn radio on while simultaneously pressing both \_F\_ key and \_ENTER\_ key.

--

DISCLAIMER: I do not own a TH-215A and have not verified the above information. Hopefully, the modified frequency range includes 162 MHz weather-broadcast freqs. Remember, it is ILLEGAL to transmit outside the ham band with non-FCC-type-accepted equipment, even if you are licensed to use such frequencies.



Date: 10 Jun 89 19:41:32 GMT  
Subject: Kenwood HT-45A mods? ( and TH-25AT )

Ok, I've promised it for a long time and now it's time to live up to my promises. Here are some mods for the TH-25AT and the TH-45AT. Please note that I do not encourage transmitting on a frequency for which you do not have a license, nor do I encourage transmitting on a non-amateur frequency without FCC type accepted equipment (in the United States). Lament: when are the Japanese going to produce a 440 FM HT for the US market that has receive coverage outside the US amateur band? Lord knows that there's a market for it - there's MONEY to be made.

First let me recommend that you buy the service manuals for these radios. The service manual is not expensive (about \$15 I think) and it will greatly help you in performing these modifications.

Look at the schematic for your radio. In the lower left hand corner is an IC labeled IC2. This is an ASIC microprocessor. At the lower right hand corner of this uP are several diodes and pull-up/pull-down resistors. They are D4, D3, R19, R18, R28, R20, R21, R22, R25, R26, and a couple of resistors that are not even on the schematic that attach to B2 (pin 51 on IC2) and B3 (pin 50 on IC2). The TH-45AT schematic shows R23 on the ASIC uP pin B2.

The schematic for the TH-25AT shows:

|         |         |     | R18-R21 | R25 | R26,27 | R28 | R36 |
|---------|---------|-----|---------|-----|--------|-----|-----|
| TH-25A  | M,M2    | -12 | O       | X   | X      | X   | X   |
| TH-25A  | M3,M4,X | -23 | O       | X   | X      | O   | X   |
| TH-25AT | K       | -11 | O       | O   | X      | X   | X   |
| TH-25AT | M,M2    | -12 | O       | X   | X      | X   | X   |
| TH-25E  | T       | -52 | X       | X   | O      | O   | O   |
| TH-25E  | W       | -62 | X       | O   | O      | O   | O   |

And the schematic for the TH-45AT shows:

|         |         |     | R19-R21 | R22 | R23 | R25 | R26,27 | R28 | R36 |
|---------|---------|-----|---------|-----|-----|-----|--------|-----|-----|
| TH-45A  | M1,M2,X | -21 | O       | O   | O   | X   | X      | O   | X   |
| TH-45A  | M3,M4   | -22 | O       | X   | O   | X   | X      | X   | X   |
| TH-45AT | K       | -10 | O       | X   | O   | X   | X      | O   | X   |
| TH-45AT | M1,M2   | -21 | O       | O   | O   | X   | X      | O   | X   |
| TH-45AT | M3,M4   | -22 | O       | X   | O   | X   | X      | X   | X   |
| TH-45E  | T       | -51 | X       | O   | X   | X   | O      | X   | O   |
| TH-45E  | W       | -61 | X       | O   | X   | O   | O      | O   | O   |

where O means USED, and X means NOT USED.

Some of the above codes are:

K USA  
T England  
X Australia  
M Other Areas

These components are found on the flexible circuit board under the display. To get to them, take the radio apart. Some unsoldering of obvious grounding wires may be necessary. You will see where the

flexible circuit board plugs into a socket on the main circuit board. Before unplugging it, make sure you know what's in the memories, because they will be lost. Unplug the flexible circuit board and unfold it so that the components are accesable. One of the fold-out parts of the flexible board will look something like this:

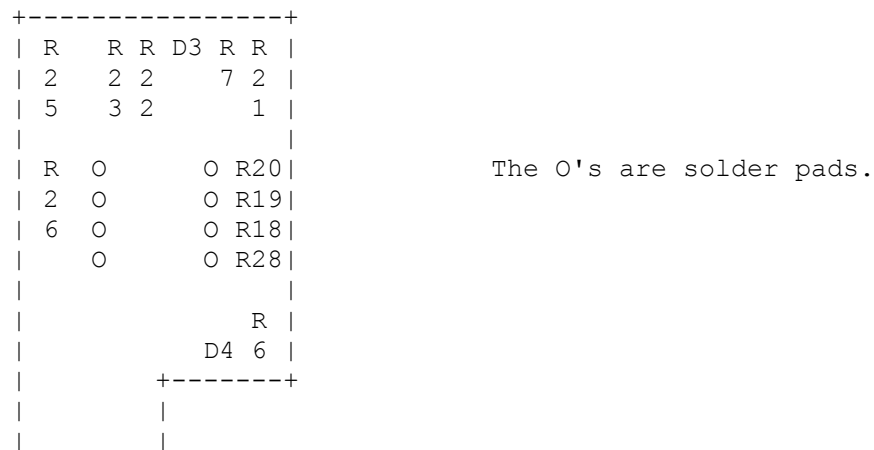

The fold out board is actually square, but with only characters for graphics, I couldn't draw it that way.

On both radios, R36 is for the European tone burst to "whistle up" repeaters.

On both radios, D4 is for selecting the type of display. With D4 in, the display is normal. With D4 removed, the display is a channel display.

D3 is for selecting VHF or UHF. With D4 in, the radio thinks its a VHF radio. With D4 removed, the radio thinks its a UHF radio. Don't change this on your radio.

On the TH-25AT:  
(All frequencies given in MHz.)

R22 in  
R28 out  
This is how the radio is delivered in the USA. TX 144-148, RX 141-163 (I think).

R22 out  
R28 in  
The radio tunes from 142-151. This may be the modification given to US MARS members. I don't remember where the unit will transmit. It may or may not transmit outside the range from 144-148.

R22 in  
R28 in  
The radio tunes only from 144-148.

R22 out  
R28 out  
Frequencies may be selected from 100-200 MHz (on the display only - your

PLL will not lock up in this entire range). In addition, TX is possible where your PLL locks up.

R25 out

Removing R25 disables automatic offset selection.

R23 and R24 are used for selecting the step size for tuning. I can't remember which positions are for which step sizes, and alas I didn't write down what I found. If you want to play with this, go ahead.

On the TH-45AT:

(All frequencies are given in MHz.)

R18 in

R28 in

This is how the radio is delivered in the USA. The radio covers 438-450 MHz.

R18 in

R20 out

The radio is prohibited from tuning outside 440-450 MHz.

R18 out

R28 in

The radio will only tune from 215-230 MHz. Note that the PLL would not lock up! (What did you expect?) Could it be possible that Kenwood originally planned a 220 version of this radio, but then scrapped their plans?

R18 out

R28 out

The radio will tune from 200-500 MHz (on the display only - your PLL will not lock up over this entire range). Transmitting is possible anywhere your PLL will lock up.

I have found a quick and easy way to retune your PLL (in the TH45-AT) with a minimum of test equipment. All you need is a scope and a small tuning tool. First, take off the battery pack holder plate. Then, remove the silvery sticker covering the tuning pot access holes. If the radio is positioned on its back, with the top folded over so that the touch tone pad is also facing down, the test point you want (TP1) is on the bottom half of the radio, near the center (left to right), and close to the battery; the tuning pot you want (TC1) is on the bottom, and closest to the PTT switch. Under no circumstances change the tuning of TC51. This is used to calibrate the output of the radio with the display the radio is giving; you don't want to mess with it. Once again, the Service Manual makes it very clear where these points are, if you are having trouble with my descriptions. On with retuning the PLL. With the radio on, and receiving, monitor the voltage and the waveform on test point TC1. Tune the radio DOWNWARDS in frequency until the PLL unlocks. Note that the radio will beep when this happens, and the waveform on TP1 will change. Tune the radio about 1 MHz higher so that the PLL locks up again, and note the voltage on the testpoint, TP1. Now, tune the radio to the LOWEST frequency that you want to be able to receive. Adjust TC1 until the voltage on the test point TP1 is the same as what was noted earlier. Button the radio back up, and you're done. You will not be able to tune the PLL to any range you want.

There are limits. On my radio, I have been able to retune the radio so that I can receive from 439.2-468.6 MHz with a set of batteries fresh out of the charger. The tuning range will probably diminish as the battery voltage decreases. I have not retuned the PLL on my 2m HT, but I'd imagine the same technique will prove fruitful.

I may have some more information on these radios someplace. If I can find it, I will add to this posting, and post it again with the updated information. Enjoy.

In the rare case that original ideas are found here, I am responsible. Internet: hendrick@frith.egr.msu.edu

Kenneth J. Hendrickson  
Owen W328, E. Lansing, MI 48825  
UUCP: ...!frith!hendrick

N8DGN

[ Editor Note: With my radio, I had to remove the following resistors to enable full rx/tx: R19, R20, R21, R22, R28 de VE3PZR ]



From: aviator@athena.mit.edu (Joakim Karlsson)  
Subject: Re: Needed: Kenwood TH-26A and TH-46A Mods  
Date: 3 Oct 91 12:50:26 GMT  
Organization: Flight Transportation Associates, Cambridge, MA  
Lines: 177  
Nntp-Posting-Host: e40-008-10.mit.edu

What follows below is the most extensive description of TH-27A mods that I have ever seen. Sorry about the ALL CAPS, it came that way. I've performed the "snip-the-green-wire" mod on mine in order to be able to use it for the Civil Air Patrol. Works great. ...Joakim

---- Cut here ----

The following info on the TH27A was posted before, just after Christmas, and is reposted due to recent queries. Please respond directly to the author, Tom, at Internet: N5OFF@W5DDL.AARA.ORG,  
Packet: N5OFF@K5ARH.#LFTLA.LA.USA.NA

I HAVE BEEN DOING SOME EXPERIMENTING WITH MY TH-27A, AND HAVE FOUND IT TO BE AN EXCELLENT AIRCRAFT RECEIVER AS WELL AS A FINE TWO METER TRANSCEIVER. IT WILL ALSO DO FULL 136-174 MHZ TX/RX, BUT I HAVE NOT YET FOUND A MOD CONFIGURATION THAT WILL ALLOW FULL TX/RX AND AIRCRAFT RECEIVE AT THE SAME TIME (EXCEPT THE ASIAN CONFIG, TH-F27, WHICH I WILL DESCRIBE BELOW).

WHEN MODIFIED FOR FULL 136-174 TX/RX IN ANY OF THE WESTERN CONFIGS THE AIRCRAFT AM IS DEFEATED (SEE CHART BELOW). IN THE ASIAN CONFIG, THE RIG BECOMES A VERSATILE WIDE BAND RECEIVER 118-174, 200-400 (DISPLAY ONLY) AND WILL TX 136-174. THE PROBLEM WITH THIS CONFIG IS THAT SOME OF THE KEY POSITIONS BECOME RELOCATED (SEE CROSS REFERENCE). THE KEY DIFFERENCES ARE OBVIOUS IF YOU COMPARE A JAPANESE KENWOOD BROCHURE WITH A YANKEE ONE.

SO, CAN ANYONE OUT THERE SHED SOME LIGHT ON HOW TO GET FULL 136-174 TX/RX AND PRESERVE THE RELATIVELY HIGH QUALITY AIRCRAFT RECEIVE PRESENT IN THE WESTERN STANDARD CONFIGURATION? I HAVE INCLUDED BELOW MY SUMMARY OF THE POSSIBLE RESISTOR COMBINATIONS, ALONG WITH A PARTIAL RESULTS LIST. (DID I MISS A RESISTOR SOMEWHERE?)

| R334 | R335 | R337 | W301 | REMARKS                                     |
|------|------|------|------|---------------------------------------------|
| O    | -    | O    | O    | K,P US STOCK CONFIG                         |
| O    | O    | O    | O    | E 144-146 TX/RX NO AIRCRAFT                 |
| O    | O    | O    | -    | E2 136-174 TX/RX NO AIRCRAFT                |
| -    | -    | O    | O    | M 144-148 TX/RX NO AIRCRAFT                 |
| -    | -    | O    | -    | M2 136-174 TX/RX NO AIRCRAFT                |
| O    | O    | -    | O    | X 144-148 TX/RX                             |
| O    | -    | O    | -    | US MARS 118-174 RX 142-152 TX               |
| O    | -    | -    | -    | US MARS+ 136-174 TX/RX NO AIRCRAFT          |
| -    | -    | -    | O    | ASIAN STOCK                                 |
| -    | O    | O    | -    | ASIAN MOD 118-174,200-400 RX,<br>136-174 TX |
| O    | O    | -    | -    | 136-174 TX/RX NO AIRCRAFT                   |
| O    | -    | -    | O    | NOT TRIED                                   |



|   |   |   |   |                                                          |
|---|---|---|---|----------------------------------------------------------|
| - | 0 | - | 0 | NOT TRIED                                                |
| - | 0 | 0 | 0 | NOT TRIED                                                |
| - | - | - | - | ASIAN RECEIVE MOD 118-174 RX,<br>200-400 RX, 144-148 TX  |
| - | 0 | - | - | COMMERCIAL 136-174 TX/RX, 5.7 MHZ<br>OFFSET, 150 DEFAULT |

"0" MEANS RESISTOR OR JUMPER IN PLACE

"-" MEANS OPEN

THE FIRST SIX CONFIGS ARE SHOWN ON THE KENWOOD SCHEMATIC  
W301 IS OUR OLD FRIEND, THE GREEN WIRE.

TH-27A TO TH-F27 (ASIAN VERSION) KEY RELOCATIONS

|               |   |                     |
|---------------|---|---------------------|
| TH-27A KEY    | = | TH-F27 KEY          |
| TONE/TONE SEL |   | CALL/C-SCAN         |
| CALL/C SCAN   |   | BELL/STEP           |
| 3 TALT        |   | 3 TONE              |
| SHIFT/REV     |   | REV/SHIFT           |
| MHZ/STEP      |   | MHZ (NO F FUNCTION) |

I HAVE SETTLED ON THE ASIAN MOD FOR MY TH-27A, AND FIND THAT  
THE BUTTON DIFFERENCES ARE EASY TO LIVE WITH. ALL FUNCTIONS ON THE  
RIG SEEM TO WORK IN THE ASIAN CONFIG EXCEPT I DON'T THINK THE  
AUTO-DIALER WILL DIAL A \* OR #. NO BIG DEAL FOR ME. IT WILL MANUALLY  
SEND A # OR \* THOUGH.

AS STATED EARLIER, THE COVERAGE OF THE RIG IN THE ASIAN CONFIG IS

118-136 AM RX (WITH A REAL AM DETECTOR)  
136-174 FM TX/RX  
200-400 RX

I DON'T THINK THE 200-400 WORKS AT ALL BECAUSE I'VE COMPARED IT  
TO STRONG LOCAL SIGNALS ON A SCANNER AND HEARD NOTHING ON THE  
TH-27A. SEE THE SENSITIVITY MEASUREMENTS BELOW.

OTHER BUTTON DIFFERENCES NOT MENTIONED EARLIER ARE:

|          |                |                         |
|----------|----------------|-------------------------|
|          | TH-27A         | TH-F27                  |
| F1SEC, 3 | TONE ALT SOUND | TONE SELECT             |
| F MHZ    | STEP           | BAND SWITCH 118/145/340 |

OTHER NOTES:

AUTOPATCH WORKS WELL

CTCSS TONES SENT OK, DTMF AND CTCSS SQUELCH WORKS

BAND SCANNING, ETC WORKS OK

PROCESSORR RESET DEFAULTS TO 145.000 INSTEAD OF 144.000

TX/RX NO PROBLEM ON VHF FM

RX AIRCRAFT, GREAT! AS GOOD AS A BEARCAT 100/200, BETTER THAN ICOM 2SAT. THE TH-27A HAS A "REAL" AM DETECTOR/AGC (SEE SCHEMATIC).

WISH LIST, FOR SOMEONE ON THE NET TO FIGURE OUT THE MOD TO GIVE 136-174 TX AND PRESERVE THE AIRCRAFT RECEIVE IN ONE OF THE STANDARD US OR WESTERN CONFIGURATIONS. IS IT NECESSARY TO GO TO THE ASIAN CONFIGURATION TO HAVE YOUR CAKE AND EAT IT TOO?

SENSITIVITY MEASUREMENTS

TH-27A 12/18/90

USING AN IFR MOD 1000S SERVICE MONITOR

REFERENCE IS 1 LED SEGMENT LIT

1000 HZ TONE

| FREQ.<br>MHZ | SIGNAL<br>MICROVOLTS |    |
|--------------|----------------------|----|
| 118          | 1.7                  | AM |
| 120          | 1.5                  |    |
| 122          | 0.9                  |    |
| 124          | 0.9                  |    |
| 126          | 0.9                  |    |
| 128          | 0.9                  |    |
| 130          | 0.8                  |    |
| 132          | 0.8                  |    |
| 134          | 0.8                  |    |
| 136          | 0.8                  |    |
| 136          | 0.5                  | FM |
| 138          | 0.4                  |    |
| 140          | 0.4                  |    |
| 142          | 0.3                  |    |
| 144          | 0.3                  |    |
| 146          | 0.3                  |    |
| 148          | 0.4                  |    |
| 150          | 0.4                  |    |
| 152          | 0.4                  |    |
| 154          | 0.4                  |    |
| 156          | 0.5                  |    |
| 158          | 0.5                  |    |
| 160          | 0.5                  |    |
| 162          | 0.6                  |    |
| 164          | 0.8                  |    |
| 166          | 0.8                  |    |
| 168          | 0.8                  |    |
| 170          | 1.0                  |    |
| 172          | 1.3                  |    |
| 174          | 1.5                  |    |
| 200-400      | NO RX                |    |

INSERT USUAL WARNING/DISCLAIMER HERE.

DE TOM N5OFF@K5ARH.LA.USA

--

-- James Dugal,                   N5KNX                                   Internet: jpd@usl.edu  
Associate Director                                                           Ham packet: n5knx@k5arh  
Computing Center                                                            US Mail: PO Box 42770 Lafayette, LA  
70504  
University of Southwestern LA.           Tel. 318-231-6417                    U.S.A.

--

Joakim Karlsson                                   | aviator@athena.mit.edu  
Flying Fanatic in Training | FAA: P-ASEL CAP: Freedom 226 Mobile FCC: N1JHW  
"Oh, I have slipped the surly bonds of earth  
And danced the skies on laughter-silvered wings"



Newsgroups: rec.radio.amateur.misc  
From: Terry.Murphy@bbs.oit.unc.edu (Terry Murphy)  
Subject: TH27a Mods  
Message-ID: <1992Jun16.194528.18571@samba.oit.unc.edu>  
Sender: usenet@samba.oit.unc.edu  
Nntp-Posting-Host: lambada.oit.unc.edu  
Organization: Extended Bulletin Board Service

Date: Tue, 16 Jun 1992 19:45:28 GMT

A full review of the Kenwood TH27a ran in the March Issue 1991 of CQ

Keyboard Mods to access AM detector and change band:

Press the ENT key once or twice to place HT in VFO mode and in the 2m band  
Depress the F key for 2 secs. (Note flashing F in lower right corner)  
Release F key and press MHz key  
HT will shift to 118.00 MHz and activate the am detector  
Store any freqs from 118-138 into memory  
Hit F key till it flashes  
Hit MHz key  
Your back on 139-170MHz with FM detector

This is a very sophisticated HT and now a great bargain  
73-AB4VJ

From njitgw.njit.edu!dorm.rutgers.edu!rutgers!cs.utexas.edu!uunet!  
snorkelwacker.mit.edu!bloom-picayune.mit.edu!athena.mit.edu!aviator Fri Oct 4  
00:50:05 EDT 1991

Article: 8156 of rec.radio.amateur.misc  
Path: njitgw.njit.edu!dorm.rutgers.edu!rutgers!cs.utexas.edu!uunet!  
snorkelwacker.mit.edu!bloom-picayune.mit.edu!athena.mit.edu!aviator  
From: aviator@athena.mit.edu (Joakim Karlsson)  
Newsgroups: rec.radio.amateur.misc  
Message-ID: <1991Oct3.125026.22682@athena.mit.edu>  
Date: 3 Oct 91 12:50:26 GMT  
References: <4285@shodha.enet.dec.com>  
Sender: news@athena.mit.edu (News system)  
Organization: Flight Transportation Associates, Cambridge, MA  
Lines: 177  
Nntp-Posting-Host: e40-008-10.mit.edu

What follows below is the most extensive description of TH-27A mods  
that I have ever seen. Sorry about the ALL CAPS, it came that way.  
I've performed the "snip-the-green-wire" mod on mine in order to be  
able to use it for the Civil Air Patrol. Works great. ...Joakim

---- Cut here ----

The following info on the TH27A was posted before, just after Christmas,  
and is reposted due to recent queries. Please respond directly to the  
author, Tom, at Internet: N5OFF@W5DDL.AARA.ORG,  
Packet: N5OFF@K5ARH.#LFTLA.LA.USA.NA

I HAVE BEEN DOING SOME EXPERIMENTING WITH MY TH-27A, AND HAVE  
FOUND IT TO BE AN EXCELLENT AIRCRAFT RECEIVER AS WELL AS A FINE

TWO METER TRANSCEIVER. IT WILL ALSO DO FULL 136-174 MHZ TX/RX, BUT I HAVE NOT YET FOUND A MOD CONFIGURATION THAT WILL ALLOW FULL TX/RX AND AIRCRAFT RECEIVE AT THE SAME TIME (EXCEPT THE ASIAN CONFIG, TH-F27, WHICH I WILL DESCRIBE BELOW).

WHEN MODIFIED FOR FULL 136-174 TX/RX IN ANY OF THE WESTERN CONFIGS THE AIRCRAFT AM IS DEFEATED (SEE CHART BELOW). IN THE ASIAN CONFIG, THE RIG BECOMES A VERSATILE WIDE BAND RECEIVER 118-174, 200-400 (DISPLAY ONLY) AND WILL TX 136-174. THE PROBLEM WITH THIS CONFIG IS THAT SOME OF THE KEY POSITIONS BECOME RELOCATED (SEE CROSS REFERENCE). THE KEY DIFFERENCES ARE OBVIOUS IF YOU COMPARE A JAPANESE KENWOOD BROCHURE WITH A YANKEE ONE.

SO, CAN ANYONE OUT THERE SHED SOME LIGHT ON HOW TO GET FULL 136-174 TX/RX AND PRESERVE THE RELATIVELY HIGH QUALITY AIRCRAFT RECEIVE PRESENT IN THE WESTERN STANDARD CONFIGURATION? I HAVE INCLUDED BELOW MY SUMMARY OF THE POSSIBLE RESISTOR COMBINATIONS, ALONG WITH A PARTIAL RESULTS LIST. (DID I MISS A RESISTOR SOMEWHERE?)

| R334 | R335 | R337 | W301 | REMARKS                                                  |
|------|------|------|------|----------------------------------------------------------|
| 0    | -    | 0    | 0    | K, P US STOCK CONFIG                                     |
| 0    | 0    | 0    | 0    | E 144-146 TX/RX NO AIRCRAFT                              |
| 0    | 0    | 0    | -    | E2 136-174 TX/RX NO AIRCRAFT                             |
| -    | -    | 0    | 0    | M 144-148 TX/RX NO AIRCRAFT                              |
| -    | -    | 0    | -    | M2 136-174 TX/RX NO AIRCRAFT                             |
| 0    | 0    | -    | 0    | X 144-148 TX/RX                                          |
| 0    | -    | 0    | -    | US MARS 118-174 RX 142-152 TX                            |
| 0    | -    | -    | -    | US MARS+ 136-174 TX/RX NO AIRCRAFT                       |
| -    | -    | -    | 0    | ASIAN STOCK                                              |
| -    | 0    | 0    | -    | ASIAN MOD 118-174, 200-400 RX,<br>136-174 TX             |
| 0    | 0    | -    | -    | 136-174 TX/RX NO AIRCRAFT                                |
| 0    | -    | -    | 0    | NOT TRIED                                                |
| -    | 0    | -    | 0    | NOT TRIED                                                |
| -    | 0    | 0    | 0    | NOT TRIED                                                |
| -    | -    | -    | -    | ASIAN RECEIVE MOD 118-174 RX,<br>200-400 RX, 144-148 TX  |
| -    | 0    | -    | -    | COMMERCIAL 136-174 TX/RX, 5.7 MHZ<br>OFFSET, 150 DEFAULT |

"0" MEANS RESISTOR OR JUMPER IN PLACE

"-" MEANS OPEN

THE FIRST SIX CONFIGS ARE SHOWN ON THE KENWOOD SCHEMATIC  
W301 IS OUR OLD FRIEND, THE GREEN WIRE.

TH-27A TO TH-F27 (ASIAN VERSION) KEY RELOCATIONS

| TH-27A KEY    | = | TH-F27 KEY          |
|---------------|---|---------------------|
| TONE/TONE SEL |   | CALL/C-SCAN         |
| CALL/C SCAN   |   | BELL/STEP           |
| 3 TALT        |   | 3 TONE              |
| SHIFT/REV     |   | REV/SHIFT           |
| MHZ/STEP      |   | MHZ (NO F FUNCTION) |

I HAVE SETTLED ON THE ASIAN MOD FOR MY TH-27A, AND FIND THAT THE BUTTON DIFFERENCES ARE EASY TO LIVE WITH. ALL FUNCTIONS ON THE RIG SEEM TO WORK IN THE ASIAN CONFIG EXCEPT I DON'T THINK THE AUTO-DIALER WILL DIAL A \* OR #. NO BIG DEAL FOR ME. IT WILL MANUALLY SEND A # OR \* THOUGH.

AS STATED EARLIER, THE COVERAGE OF THE RIG IN THE ASIAN CONFIG IS

118-136 AM RX (WITH A REAL AM DETECTOR)  
136-174 FM TX/RX  
200-400 RX

I DON'T THINK THE 200-400 WORKS AT ALL BECAUSE I'VE COMPARED IT TO STRONG LOCAL SIGNALS ON A SCANNER AND HEARD NOTHING ON THE TH-27A. SEE THE SENSITIVITY MEASUREMENTS BELOW.

OTHER BUTTON DIFFERENCES NOT MENTIONED EARLIER ARE:

|         |                |                         |
|---------|----------------|-------------------------|
|         | TH-27A         | TH-F27                  |
| F1SEC,3 | tone ALT SOUND | tone SELECT             |
| F MHZ   | STEP           | BAND SWITCH 118/145/340 |

OTHER NOTES:

AUTOPATCH WORKS WELL

CTCSS TONES SENT OK, DTMF AND CTCSS SQUELCH WORKS

BAND SCANNING, ETC WORKS OK

PROCESSORR RESET DEFAULTS TO 145.000 INSTEAD OF 144.000

TX/RX NO PROBLEM ON VHF FM

RX AIRCRAFT, GREAT! AS GOOD AS A BEARCAT 100/200, BETTER THAN ICOM 2SAT. THE TH-27A HAS A "REAL" AM DETECTOR/AGC (SEE SCHEMATIC).

WISH LIST, FOR SOMEONE ON THE NET TO FIGURE OUT THE MOD TO GIVE 136-174 TX AND PRESERVE THE AIRCRAFT RECEIVE IN ONE OF THE STANDARD US OR WESTERN CONFIGURATIONS. IS IT NECESSARY TO GO TO THE ASIAN CONFIGURATION TO HAVE YOUR CAKE AND EAT IT TOO?

SENSITIVITY MEASUREMENTS

TH-27A 12/18/90  
USING AN IFR MOD 1000S SERVICE MONITOR  
REFERENCE IS 1 LED SEGMENT LIT  
1000 HZ TONE

| FREQ.<br>MHZ | SIGNAL<br>MICROVOLTS |    |
|--------------|----------------------|----|
| 118          | 1.7                  | AM |
| 120          | 1.5                  |    |
| 122          | 0.9                  |    |

124 0.9  
126 0.9  
128 0.9  
130 0.8  
132 0.8  
134 0.8  
136 0.8  
136 0.5 FM  
138 0.4  
140 0.4  
142 0.3  
144 0.3  
146 0.3  
148 0.4  
150 0.4  
152 0.4  
154 0.4  
156 0.5  
158 0.5  
160 0.5  
162 0.6  
164 0.8  
166 0.8  
168 0.8  
170 1.0  
172 1.3  
174 1.5  
200-400 NO RX

INSERT USUAL WARNING/DISCLAIMER HERE.

DE TOM N5OFF@K5ARH.LA.USA

--  
-- James Dugal, N5KNX Internet: jpd@usl.edu  
Associate Director Ham packet: n5knx@k5arh  
Computing Center US Mail: PO Box 42770 Lafayette, LA  
70504  
University of Southwestern LA. Tel. 318-231-6417 U.S.A.

--  
Joakim Karlsson | aviator@athena.mit.edu  
Flying Fanatic in Training | FAA: P-ASEL CAP: Freedom 226 Mobile FCC: N1JHW  
"Oh, I have slipped the surly bonds of earth  
And danced the skies on laughter-silvered wings"





Newsgroups: rec.radio.amateur.misc  
Path: taco!gatech!darwin.sura.net!spool.mu.edu!news.nd.edu!nova!jonathan  
From: jonathan@nova.decio.nd.edu (Jonathan Bradshaw)  
Subject: Kenwood TH28A Mods (here they are)  
Message-ID: <1992Oct5.223344.26956@news.nd.edu>  
Sender: news@news.nd.edu (USENET News System)  
Organization: University of Notre Dame, Notre Dame  
Date: Mon, 5 Oct 1992 22:33:44 GMT  
Lines: 63

I just got the following. I CANNOT VERIFY THIS. However I do know the aircraft (hold F down then LOW) toggle does work.

~From: LAIRDPG@lub001.lamar.edu  
~Subject: Re: TH28A mods? Anyone?  
  
~Date: Sun, 16 Aug 92 19:59:26 PDT

TH28A Mods:

- 1) Remove the 4 screws holding the radio together.
- 2) With your finger in the battery bay, separate the two parts.
- 3) The inside of the keypad case has a copper RF shield. Move this shield out of the way by removing the 2 screws and bending it up and away from the PC board. (There may be double sticky tape holding the shield to the IC.) Under the shield you will find a large IC surrounded by an array of diodes, as follows:

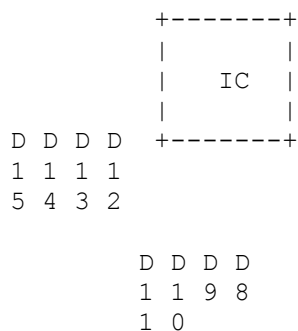

(The diode numbers are read vertically.)

NOTE: Diodes D15 & D14 are NOT present in the American version.

- 4) Remove diodes D8 and D10.
- 5) Install one of these diodes in D14.

This enables the following three extended modes:

- 1) Extended receive from 360 Mhz to 400 Mhz.
- 2) Extended receive from 400 Mhz to 520 Mhz.
- 3) Extended transmit/receive from 136 Mhz to 174 Mhz.

in addition to the existing aircraft frequencies of:

4) Receive from 118 Mhz to 136 Mhz. (AM)

(AM and FM are switched automatically according to the frequency range.)

To switch between the modes, press the [F] key for one second, then press the [LOW] key. This will switch between:

- a) Amateur VHF band (136 Mhz to 174 Mhz).
- b) 340 Mhz band (340 Mhz to 400 Mhz).
- c) Aircraft band (118 Mhz to 136 Mhz).

To get the extended amateur UHF receive, press the [BAND] key while in the 136 Mhz to 174 Mhz mode.

--

Jonathan Bradshaw | jonathan@nova.decio.nd.edu -or- jbradsh2@darwin.cc.nd.edu  
Packet: n9oxe@n0ary.#nocal.ca.usa.na | Prodigy: XMSN02B | (Os/2) (DOS) (Linux)  
WNDU-AM/FM/TV South Bend, IN | Disclaimer "My opinions are not my employers"  
- "Busy life, not enough time to look in the mirror." - Deborah Ann Gibson -



Date: Thu, 26 Oct 89 15:19 CDT  
From: SURESH KAGOO N9GSA/4S7???  
Subject: KENWOOD TH-75A MOD

TH-75A MARS/CAP MODIFICATION  
-----

This modification will allow the TH-75A to transmit from 142 to 152 MHz and 420 to 450 MHz. Specifications are guaranteed for the Amateur Bands only. Through the transceiver will display 136 to 174 MHz and 335 to 512 MHz, the PLL circuit may not lock through the entire range.

CAUTION  
-----

Protect your license. Make sure that you operate on authorized frequencies only.

MODIFICATION PROCEDURE  
-----

1. Disconnect the battery and antenna.
2. Remove the three case screws and two battery plate screws.
3. Lift the front panel from the body of the transceiver, but do not disconnect the two flex cables.
4. Cut the green jumper wire (W1) that is located to the left side of the CPU in the front panel assembly.
5. Assemble the transceiver by reversing steps 1-3.
6. Reset the CPU by holding the M key as the power is turned on.

I have tried it and it works.

Suresh Kagoo N9GSA/4S7???

Memphis State University  
Memphis, Tennessee

Internet : SKAGOO@MEMSTVX1.BITNET  
Bitnet : SKAGOO@MEMSTVX1



From: gwalsh@kilroy.jpl.nasa.gov (Gerald J. Walsh)  
Newsgroups: rec.ham-radio  
Subject: Here are the Kenwood TH-77A mods!

Here is the complete list of mods that are know to date for the Kenwood TH-77A Dual Band hand held:

>From the factory, it can receive 138-174MHz and seems to do it quite  
More? y  
well with the supplied rubber duck antenna can receive 438-450MHz and, likewise, does this quite well too! One very interesting feature of the TH77A is that it can do \*DUAL\* UHF receive! To do this it uses the VHF receive section and you have less sensitivity, but I really haven't noticed much signal degradation at all.

NOW! On to the \*EXTRA\* capabilities (there are other BASIC functions that I didn't mention, those were just the highlights).

After making a few modifications to this radio, you can get it to do the regular stuff that the IC24AT will do, such as AM aircraft, expanded UHF (400-512 depending on PLL lock) and 800-950 (again, depending on PLL lock) in addition to cross band repeat.

HOW DO YOU DO THIS!?

Easy (if you've got a steady had for removing a chip resistor!).

Open it up. There are 3 screws visible on the outside and 4 more  
More? y  
underneath the battery pack. Unlike most radios, this one doesn't have a spring for the battery release switch. It gets spring action from the metal plate that you will remove when you take out the four screws.

Anyway, the area you will be working in is on the control board which is fixed to the front section of the radio. In particular, look for the yellow electrolytic capacitor (its yellow in mine) that is at the dead center of the board (there are two IC's, one above this and 1 below this). You will have to remove the electrolytic capacitor (C124) and set it aside for a few minutes. You will be putting it back afterward. The reason for removing this is so that you can remove a chip resistor that is underneath it. To avoid tearing the flex board foil traces, do not bend the leads of the capacitor. There is a green wire that is connected to one side of this capacitor. If you disconnect one side of this green wire, you will get RX from 400-512 (PLL lock depends on the radio, but you can DIAL from 400 to 512). Orient the radio so that the volume controls and BNC are at 12 O'Clock on your table (farthest from you) and the bottom (where the battery connects) is at 6 o'clock area where you

More? y  
removed the capacitor, you will see a blank space where there could have been a chip resistor followed by two chip resistors side-by-side and in the next row below that, you will see 3 more that are side-by-side. There is one to the left of these two rows that is kind of off center. Now, there are three ways to configure this radio at this point:

- 1 - With one side of the green wire pulled, you will have 136-174 RX, 400-512 RX. If that's all you want, you are done.
- 2 - By removing the rightmost chip resistor (R129), in addition to keeping one side of the green wire disconnected, you will have 136-174 RX, 400-512 RX, 118-136 AM RX, 800-950 RX.
- 3 - By removing both of the chip resistors, in addition to putting the green wire BACK where it belongs, you will have 136-174 RX/TX, 400-512 RX/TX, 118-136 AM RX and 800-950 RX.

All three of these options include, of course, putting the electrolytic capacitor back in place afterwards.

NOTE! ONCE YOU START DOING THIS STUFF, YOUR MEMORIES AND POWER ON SWITCH More? y CONFIGURATIONS WILL ALL BE LOST! MAKE A NOTE OF HOW YOU ARE SETUP BEFORE YOU BEGIN!

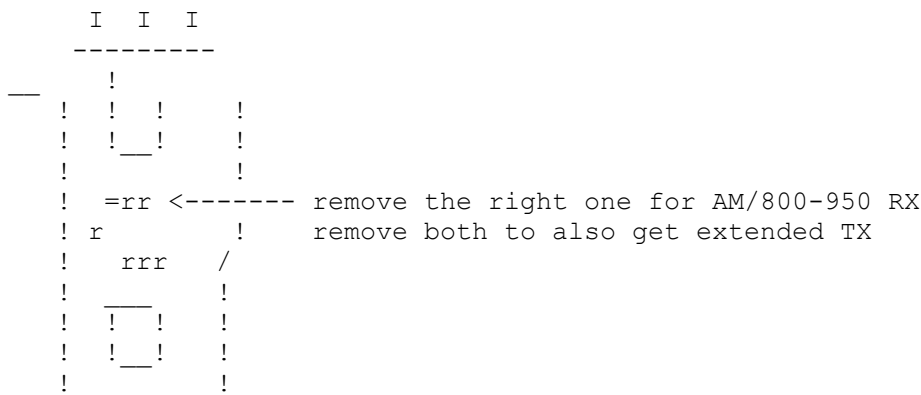

Layout shown with electrolytic capacitor C124 removed

The best way to do this is to heat up both sides of the resistor and More? y push it out of the way with something small. At least this was the best way for me! Once it's out, put the capacitor back in place and close it up. (Put the green wire back also, if you are making the out of band TX mod too!)

#### TO OPERATE THE NEW FEATURES

To receive AM aircraft, get the VHF side in the main band and hit the ENT key twice to go to the VFO. Once you are in the VFO, hit the UxU key twice. Once for dual UHF receive and the 2nd time for AM (118-136).

To receive 800-950, get the UHF side in the main band and hit the ENT key twice to go to the VFO. Once you are in the VFO, hit the UxU key once.

To enable crossband repeat, hold down the SUB BAND UP ARROW key while turning on power. To disable, do the same thing again. Kenwood says that both bands can contain shift information but only one band can include an encode/decode tone.



More? y

One more thing. The POWER ON + 8 KEY that allows you to select the kind of memory recall will be a bit different. Now, you will have an extra option in the right side of the display. E1 or E2 which may be selected with the VFO control on the top of the radio. E1 mode will allow you to automatically make the radio switch to AM or switch to the 800MHz stuff as you use the VFO knob to move through your memory channels. E2 mode will skip over any memories that are AM or 800-950MHz. In E2, the only way to recall one of the \*special\* memories is to go to the VFO, hit the UxU key to go to AM or 800MHz and then recall one of these memories. Personally, I have mine in E1 and don't know any reason why anyone would want to be in E2, but its there if you need it!

The Kenwood modification sheet says the following about AM sensitivity:

While the receiver sensitivity is neither specified nor guaranteed for the AM range, the sensitivity is typically less than 1uV for 10dB signal plus noise to noise ratio between 123-131MHz. The band edges, however, measure between 8-20uV for 1dB S+N/N ratio.

More? y

SOME PERSONAL OBSERVATIONS

My radio seems to have a hole in it in the 800MHz band. I get this beeping sound when I try tuning between 864-875MHz (I believe the TH77A beeps when it can't lock). Also, the sensitivity could be better around 483MHz (local Sheriff). I did notice that using the dual UHF receive and tuning to 483MHz was better than using the straight UHF receive. (Remember, the dual UHF RX uses the VHF section with reduced sensitivity. Well, its reduced in the amateur portion, but seems to be enhanced out of the band!) At around 506MHz (Los Angeles PD) its VERY weak. I could barely hear anything WITH an outside antenna. Maybe some tweaking inside could improve this (I haven't really looked for the VCO yet).

By the way, Pontus did mention that checking the input frequency was a bit annoying. You have to hit FUNCTION SHIFT to get the radio to REVERSE and listen to the input. I agree!

Anyway, hope this information helps you get more from you new toy!  
Its a \*REALLY\* nice radio!!

Gerald J. Walsh  
Jet Propulsion Laboratory

-----  
Note: I haven't tried or verified this, proceed at your own risk. WA2ISE  
And don't transmit out of band!





Remove D4 = Cross band repeat  
Remove D5 (or W1) = Mars/CAP  
Remove D6 (or W2) = Wide band rcv

The book doesn't seem to indicate that D6 is necessary for wide band receive, so try removing only D3 (and D4 if you want) and see if you get all the capabilities. If not, then remove D6 too.

D5 has priority over D3, so DO NOT REMOVE D5 if you want full xmit. I had already made the mods for the OLD MODEL (which included the removal of D5) and had to resolder D5.

| Left VFO                 | Right VFO                  |
|--------------------------|----------------------------|
| 50.000-85.2x (with beep) | 50.000-110.xxx (with beep) |
| 85.2x-179.995            | 110.xxx-179.995            |
| 300.00-399.975           |                            |
| 400.000-511.9875         | 400.000-511.9875           |
|                          | 800.00-999.9875            |

xxx is variable. My guess is the beep is some sort of error notation of some kind, but what? Someone, somewhere said it has something to do with the PLL...

At this time, I can't do the xmit testing since I don't have a dummy load here.

We had a dummy load when we were testing the mod from the 5A book and the xmit opened up to much more than the MARS/CAP mod allowed.

Brendan  
(No call yet - passed Tech exam on Jan 3rd)

=====  
Note: I haven't tried or verified this, proceed at your own risk. And  
DO NOT transmit outside of legal bands! WA2ISE  
/EX



Subject: Guide to TH-78A Undocumented Features  
The Complete Guide to Undocumented Features of the TH-78A

The information contained in this document is derived from many sources. Unfortunately, I have not kept track of everyone who has provided input, but I would like to thank those who have helped me compile this information.

This document is probably not complete: Please send any additions or corrections to [aviator@athena.mit.edu](mailto:aviator@athena.mit.edu) (Internet) or [nljhw@kalsrd.#ema.ma.usa.na](mailto:nljhw@kalsrd.#ema.ma.usa.na) (amateur radio packet) or [ma0226@malbbs.mawg.ner](mailto:ma0226@malbbs.mawg.ner) (Civil Air Patrol packet).

I've had one report that the TH-78A is capable of in-band full duplex operation. I've been unable to repeat this on my unit, which only has the CAP/MARS mod perform. Confirmation of this feature would be appreciated.

Please Note: I can take no responsibility for any problems which may be caused by attempting to access one of the features described here. This document may be distributed in its original form only, and not via packet radio.

## 1. Hardware Mods

Hardware modifications for the TH-78A are performed by manipulating a series of 6 surface mounted diodes, identified as D1 through D6. The TH-78A block diagram contains a table identifying 7 configurations involving D2, D3, D5, and D6. However, none of the configurations described below are included in that table.

To open the radio, follow the instructions on p. 64 of the manual. The two TX/RX busy indicators (LEDs) have rubber seals placed over them. These have a tendency to fall off when opening or closing the radio.

The diodes are located on the CPU board, which is mounted inside the front panel of the radio. The CPU board is readily identified by a brass shield covering the CPU, as well as the socket for the ME-1 memory expansion chip. All position references in this document assume that you are looking at the CPU board with the rotary encoders and TX/RX busy indicators at the top. If you have installed the ME-1 EEPROM, I recommend that you temporarily remove it to facilitate access to the diodes.

The diodes are located in a vertical row just below the lower right corner of the brass shield. The diodes are numbered sequentially, starting with D1 at the top.

The U.S. stock configuration has all diodes in place. The function of D1 is not known at this time. D2, D3, D5, and D6 are thought to control TX and RX ranges. D4 controls cross-band repeat.

Before removing a diode, Kenwood recommends unsoldering the brass shield. There are four solder points, one at each corner. The brass shield is attached to the CPU with a small piece of double-sided adhesive tape. An alternate method consists of unsoldering the right side of the appropriate diodes, which are visible underneath the shield, and bending them to approximately a 45 degree angle, forming an open circuit.

## Early Model Radios Only

=====  
CAP/MARS mod: Remove D6 only. Yields RX 118-174 TX 142-152 RX 400-512  
TX 425-455

Beyond MARS mod: Remove D5 only. Yields RX 50-180 TX 136-180 RX 300-400  
[VHF side only] RX 400-512 TX 400-512 RX 800-950 [UHF side only]

## Late Model Radios Only

=====  
Beyond MARS mod: Remove D3. Also remove jumper W1. Yields RX 50-180  
TX 136-180 RX 300-400 [VHF side only] RX 400-512 TX 400-512 RX 800-950  
[UHF side only]

Note: The frequency ranges include the lower limit, but exclude the upper  
limit (i.e. 118-174 really means 118.000-173.995).

Crossband repeat mod: Remove D4. Apparently, this mod is independent of the  
D5/D6 mods.

## 2. Undocumented Features

Crossband Repeat: Press F for 1 second, then 0 [requires D4 mod] Repeat the  
same sequence to disable.

Wideband RX: Press F for 1 second, then BAND [requires D5 mod] On the VHF  
side this yields 300-400 RX, on UHF 800-950 RX.

Sample Channels: Press DUAL during power-up Programs some sample  
frequencies in VHF and UHF memory channels (it's a pain to undo the  
sample programming).

Cloning: Press 0 during power-up [requires D5 or D6 mod] Allows cloning  
over the air. All keys except PTT and POWER are disabled. Press PTT to  
send DTMF cloning sequence. Presumably, receiving TH-78A must be in  
same mode.

Toggle SHIFT/SPLIT Mode: Press SHIFT during power-up This is described in  
the manual, but the documentation is not complete. The TH-78A can  
operate in two modes: In SPLIT mode, non-standard offsets (i.e. split  
frequencies) are supported, but the default offset is not programmable.  
In SHIFT mode, non-standard offsets are not allowed, but the default  
offset is programmable. To select the default offset, press F for 1  
second, then SHIFT. See p. 30 of the manual for details on changing the  
default offset.

Toggle CALL Button Function: Press CALL during power-up. The CALL button  
can operate in one of two modes. In th default mode (CALLSW), it  
switches between the call channel and the last memory channel (if in  
memory recall mode) or last frequency (if in VFO mode). After toggling  
the CALL button functionality (VMC), it will switch from the VFO to the  
last memory channel and then back to the CALL channel.

=====  
Game Mode: Press M and PTT during power-up [be careful not to accidentally reset the memory (M+POWER)]

[Much of this was provided by james@brokaw.lcs.mit.edu]

To exit the game mode at any time, press the LAMP key. It is not possible to change the volume, lamp, or frequency settings while in game mode. The top part of the display will show H.00, which represents the high score. The lower part shows a scrolling message, "PRESS ANY KEY". Pushing any key starts a "Follow Simon" type game. The display will briefly show one of the characters "1", "2", "3", or "F". Press the corresponding key. The game consists of repeating the displayed character sequence, which increases by one character each round.

After you "win" the Simon memory game by getting correctly entering a sequence of twenty characters, the next game is a draw poker game. The way it works is that you choose your bet (from 1 to 10) by pressing 2 to increment the bet and 5 to decrement the bet. Then, press F to deal the five cards. The face value of the cards is displayed, and the suits can be seen at any time by holding down the PTT key. Any number of cards may be discarded, and to select (or deselect) a card for discarding, press the keys 1, 2, 3, 4, or 5. If a card is selected for discard, it is displayed "face-down".

Press F again to draw new cards. Your new cards will be displayed, and then if your hand is 2-pair or better, the screen will show the rank of your hand on the left (2P for 2-pair, 4K for four-of-a-kind, etc.). On the right the pay-off for that hand will be displayed. Your bet is multiplied by the pay-off factor, and the resulting pile of cash is displayed in the right hand side of the upper screen. (The left hand side of the upper screen contains your table stakes, which are initially 100 coins from winning the Simon game.)

If you win the poker hand, pressing any key steps into the next stage. If you lose the poker hand, your bet is deducted from your stakes and you are asked to start another poker hand. In the next stage, you are asked "TRYB/S" which means, "Do you want to try double-or-nothing in a guessing game for Big or Small cards?" Press F for yes, press TONE for no. If you say no, your winnings are credited into your stakes and you are asked to start another poker hand. If you say yes, then a single shuffling/incrementing card is displayed on the left, and three stars are displayed on the right. You have to choose to go for either BIG or SMALL, by pressing 2 or 5. You can keep pressing 2 and 5 to change your mind. When you are ready, you must try to hit the F key to stop the rotating card display, and the card will show, and you will either win, lose, or draw. If you draw, you have to play big/small again, I think. If you lose, your winnings are gone and you can play poker again. If you win, your winnings double and you are asked whether you want to play big/small again.

The payoffs on the poker are set against you, odds-wise; the double-or-nothing game includes a draw, so the odds are against the player there unless you can time hitting the F key to win more than half the rounds. I haven't managed to do this, so I don't know if there is anything beyond this, all I know is that when the table stakes are exhausted, you go back to playing Simon again.







From: George\_Lin@mindlink.bc.ca (George Lin)  
Newsgroups: rec.radio.amateur.misc  
Subject: Re: Kenwood TH-78 mods / Game  
Message-ID: <13077@mindlink.bc.ca>  
Date: 30 Jun 92 09:38:25 GMT  
Organization: MIND LINK! - British Columbia, Canada  
Distribution: world  
Lines: 125

To "open up" as many feature as possible on the TH78A, remove diodes D4 & D5 (located under the copper shield).

This allows the following transmit and receive frequencies

| RECEIVE           |          | TRANSMIT    |
|-------------------|----------|-------------|
| -----             |          | -----       |
|                   | VHF BAND |             |
|                   | -----    |             |
| 50-135.995 (AM)   |          | (NA)        |
| 136-179.995       |          | 136-179.995 |
| 300-399 (AM & FM) |          | (NA)        |
|                   | SUB-UHF  |             |
| 400-511.99        |          | 400-511.99  |
|                   | UHF BAND |             |
|                   | -----    |             |
| 400-511.99        |          | 400-511.99  |
| 900-949.9875      |          | (NA)        |
|                   | SUB-VHF  |             |
| 50-179.995 (FM)   |          | 136-179.995 |

PERSONAL NOTES:

I found that marine weather reports at 162.40MHz in my area were received much better on the VHF-SUB band, than on the VHF band. Possible hole?

If you are having problems with intermod, try switching BANDS (ie. USING the SUB-VHF rather than the VHF etc.)

Cellular Phones are in the 870-890 range, but the frequency increments are every 30kHz. The TH78A will only increment in 25kHz steps at this frequency range, so the exact Cellular channel frequency cannot be tuned in (most of the time).

Removing D4 enables the CROSS-BAND REPEATER function.

CROSS-BAND REPEATER

-----  
Press [F] key for 1 second, then the [0] (zero) key to turn this function on and off (MHz dot will flash when in repeater mode).

ANSWERBACK FUNCTION (during paging reception)

-----

Hold down [MHz] key and switch power ON to turn this function ON or OFF.

#### 300 MHz AM/FM SWITCHING

-----

Hold down [VFO] key and switch the power ON to switch between AM and FM reception.

#### VHF & UHF EXPANSION

-----

Press and hold the [F] key for 1 second, then press the [BAND] key in the respective bands.

#### CHANNEL DISPLAY MODE

-----

Hold down [3] key and switch the power ON. Channels are displayed by number instead of frequency. (NOTE: this function only works when Alpha-Numeric memory is enabled)

#### CLONE FUNCTION

-----

Hold down the [0] and switch the power ON.

#### \*\*\* GAME \*\*\* (Available without any modifications)

-----

Hold down the [M] and [PTT] keys and switch the power ON.  
(Be very careful the PTT is depressed or else a memory reset will occur.)

1) Play the memory game.

The radio will beep and display one of the following characters: "1, 2, 3, F" (top row of buttons). Radio starts with one character and adds a new one on after every round until 20 characters are reached. You must press the keys in the same sequence they are displayed. When you can follow the radio for 20 characters, then you will win 100 coins and enter the poker game.  
(Note: I am terrible at this game, so I cheated by writing down the character sequence on paper.)

2) Poker game. (Much more interesting than the first game, IMHO)

Place the bet (1 to 10).

Increase the bet with the up key [2], decrease the bet with the down key [5].

Press [F] to deal the cards.

Cards are (2,3,4,5,6,7,8,9,+,J,K,Q,A NOTE: 10 = "+")

Press [PTT] to see the suits.

Press numbers 1 through 5 to change the respective cards.

Press [F] to deal the new cards.

If you win any amount, you can bet for double or nothing.

Press [F] to play "BIG or SMALL".

Press [LOW] to keep your winnings.

#### BIG or SMALL

-----

A random card will be chosen.

Push [2] (big) if you think this card is going to be larger than 8.

Push [5] (small) if you think this card is going to be less and 8.

(if an 8 is drawn, then a tie occurs, and you neither win nor lose)

Press [F] to draw the random card.  
You either double your winnings or lost it all.

Press [F] to continue playing Big or Small.  
Press [LOW] to keep winnings and continue playing poker.

Push the [LAMP] key to exit the game mode.

Note: While in game mode, receive functions still operate!

-----  
| George Lin                   | 145.270 MHz |  
| George\_Lin@mindlink |    VE7FKU    |  
-----



Newsgroups: rec.radio.amateur.misc  
From: rfc@allegra.att.com (Robert F. Casey)  
Subject: TH78A mod file, crossband repeat, extended RX/TX, cloning  
Message-ID: <1992Oct25.051148.8822@allegra.att.com>  
Organization: AT&T Bell Laboratories, Murray Hill, NJ  
Date: Sun, 25 Oct 1992 05:11:48 GMT  
Lines: 156

copied from packet:

```
Msg# TSF   Size #Rd Date  Time Arrived Seq #      Msg ID      Route
2182 BF    7214  2 22-Oct 1938z 22-Oct (019609 - 029771WT3V ) []
N2CZF ==> MODS@ALLUSA
"TH-78A Modification File"
```

Date: 22 Oct 92 15:38:10 EDT (Thu)  
From: n2czf@wt3v.nj.usa (Rich Garcia)  
Message-ID: <029771WT3V>  
Reply-To: n2czf@wt3v.nj.usa  
To: mods@allusa

FILENAME:TH-78A.MOD June 25,1992  
Revised: October 22, 1992  
Modifications for the Kenwood TH-78A Dual Band Micro-HT.  
By Rich Garcia N2CZF. Packet Via N2CZF@WT3V.NJ.USA

Owner assumes all responsibility for modifying or using these modifications!.

The following mods will provide for Crossband Repeat and extended receive and transmit on the Kenwood TH-78A HT.

I believe other functions are also enabled by these mods. which I have not found yet but I will update the file as news progresses.

Diode #4- Crossband Repeat  
Diode #5- Extended Receive and out of band Transmit.

Remove all screws and open radio as explained in the Kenwood manual for installing the memory expansion module.  
On the back cover you will find the memory expansion module socket and a copper shield to the upper left corner of it.  
Under this shield there will be a row of SMC diodes which are unmarked in a vertical configuration to the lower right portion covered by the shield.

#1 Remove the shield at its four corners with a solder sucker and SMALL! iron.

#2 Carefully count down from the 1st diode in the row to the fourth one and remove for crossband repeat.  
HINT: I found if you BRIEFLY touch the iron to the right side lead while gently pulling up on the SMC diode it should completely come off without needing to apply heat to the other side and further risk board damage.

I used a pair of right angle surgical tweezers for this.

#3 Just as above you may remove the fifth diode to preform the extended receive and transmit modification.

#4 Reset the CPU (yes you will loose all of your programed memories! argh!) by pressing Function for more than one second and then "0".

YOU HAVE NOW COMPLETED THE MODIFICATIONS!

#5 For 800Mhz go to the UHF band with the band switch and press Function for more than one second quickly following with a press of the Band switch again. 8---.-- will appear.

#6 For 300MHz go to the VHF band and repeat as above. Original bands are restored by repeating the "F Band" sequence.

MY observations... All original functions have maintained the same which is great. Aircraft band which was accessible before the mod remains with the same characteristics. It seems that VHF-High band has improved a bit on sensivity where it was dead as a dog before the mod (above 155.000MHz) but the 162.000 MHz band where weather radio is is still a bit deaf for reception at any distance but about 20 Miles. This depends on your (or my) terrain and transmitter output power.

On UHF all public safety frequencies up to about 500 MHz seem to come in well but sensivity greatly drops from there (we really can't ask for more). Frequencies can be programed in up to the 920MHz ham band but I have no way of measuring sensivity. 800MHz works but the signals are very weak, you must be near the transmitter for reception. Assuming you are in the town or city where the transmissions originate it should work.

Transmit is enabled up to and incl. 500MHz but after testing this on a frequency counter I find that a signal is only generated to about 490 MHz, even though the trans. LED shows output in the higher frequencies.

Crossband repeat seems to work fine but the audio is unacceptable for use, BE AWARE the radio gets HOT! Prolonged use or use on a busy frequency would not be recommended. Also remember this is a dual band HT please use a proper antenna while in this mode to avoid a high SWR, we should all know better... Right?

After first booting up the CPU in the mod I found that the message screen showed "Cloning" so it seems that this radio now has cloning capabilities. After searching I have found that holding the "0" key and powering up the radio will display the clone feature, see below for further explanation. This leads me to believe that this HT may have some more "Hidden" features that I am trying to find, some may be useful.

Thanks to Gary KC8UD who sent me the following via packet .....

CLONING:

The TH-78 can be cloned without cloning cables or special equipment. It is



done

entirely with RF, and, in fact, can be transmitted over the air, and even via repeaters. This may be extremely useful for those users who do not have the patience to program their own radios themselves. This application would also be useful for clubs and user groups. (However, this can take as long as 50 minutes with the ME-1 expansion module. It is recommended that a dummy load be used to prevent unwanted QRM.)

- (1) Both radios must be on the same frequency.
- (2) Activate both radios by pressing the "0" key while turning the power on. The radios will display CLONE.
- (3) Now, click the PTT of the "master" radio. The radio will transmit in the economy low power mode. This may take about 4 minutes for fifty channels. When the data has been transferred, both radios will revert back to the original frequency.
- (4) Turn both radios off and then on again. They will now operate normally while the slave radio has the same memory contents as the master radio.

\*\* I have not tried the following modification myself, try at your own risk \*\*

\*\*\* Rich N2CZF \*\*\*

#### FREQUENCY EXPANSION

(1) You can receive from 340 - 399.987 Mhz FM by removing chip diode D8 on the control unit. To access this function, press the [F] key for one second, and then the [LOW] key. This toggles between AMATEUR, AIR band (AM) and 360 Mhz. AM and FM modes are selected automatically, depending on frequency.

\*\* Since "F" for a second and "Low" toggles the power output, I wonder \*\*  
\*\*\* Rich N2CZF \*\*\*

There is also a couple of arcade type games on the TH-78A. To start the game you press and hold [PTT] and [M] keys while turning the unit on. The first game is a follow me type game. The radio beeps and shows a sequence of numbers flashing on the screen. You have to match the same sequence on the tone pad. Each time the sequence gets longer by one number. You have to keep remembering the sequence as one gets added each time. Once you get to a certain high score on that game, it breaks into a poker type game. To exit the game mode press the LAMP key at any time. The receiver still works in the game mode and you can adjust volume but no other features.

RG> The games seem to work fine and it is interesting that they have inserted that into the programming of the chips. Does anyone know of any further features in the radio be it games or radio functions.

73's Rich N2CZF Bricktown, NJ

=====  
Note: I haven't tried or verified this, proceed at your own risk. And do not transmit outside of legal bands! WA2ISE



Subject: More TH 78 Mods

Hello all,

This is again the TH-78 mods i archived, original is from PE1ACG @ ON4UBO i received on packet.

If you have other mods, please send them to me to complete my archives, THANKS.

Frederic,

FC1JSO @ stna7.stna.dgac.fr

-----  
SECRET FUNCTION MANUAL OF THE KENWOOD TH-78x PORTO

TH-78E RX EXPANSION (ON)

Press PTT + VFO, then POWER ON.

New RX ranges after this modification:

VHF Band 50 - 136 Mhz only AM)

136 - 174 Mhz (only FM)

320 - 390 Mhz (AM + FM) see note below.

UHF Band 405 - 510 Mhz (only FM)

800 - 950 Mhz (only FM)

VHF Band:

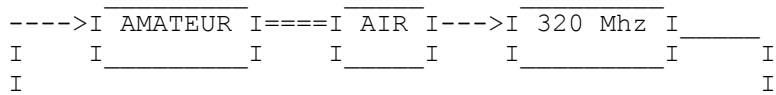

UHF Band:

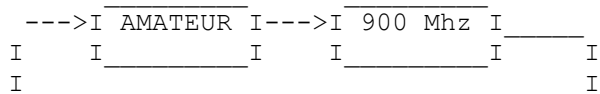

Note: Receiving mode of the 340 Mhz Band can be switched fr[m FM to AM by press and hold VFO key then POWER ON.

TH-78E RX EXPANSION (OFF)

Reset your TH-78E by pressing the I M I key, when powering ON  
I I

TH-78E TX EXPANSION

Remove the diode D6 from the control unit.

New TX ranges after this modification:

VHF Band 136.000 - 174.250 Mhz (FM)  
 UHF Band 400.000 - 493.000 Mhz (FM)

TH-78E UHF BAND 432-438 Mhz LIMITED RANGE

Remove the diode D3 from the control unit.

TH-78A/E EXTENDED FUNCTION

You can change the frequency range and use various secret function of the TH-78A/E by changing his destination. A secret function is available without modification.

Destination modification

The destination is determined by diodes D2, D3, D5, and D6. Change the destination with reference to table 2. For information about setting the destination by diode, see the destination column of table 2.

The diodes are protected by a shield plate. Remove the shield plate, then remove the appropriate diodes.

Refere to your schematic diagram TH-78A/E 2/2  
 Control Unit Board X53-342X-XX A/5

|   |              | Copper shield plate | Table 2 |             |         |         |         |        |
|---|--------------|---------------------|---------|-------------|---------|---------|---------|--------|
| : | _____        | :/                  | I       | I           | I       | I       | I       |        |
| : |              | :                   | I       | I           | I       | I       | I       |        |
| : | I _____ I    | :                   | I       | Destination | ID2     | ID3     | ID5     | ID6    |
| : | I CPU I      | :                   | I       | -----I      | -----I  | -----I  | -----I  | -----I |
| : | I IC 7 I     | :                   | I       | 0-00 (J)    | INo     | INo     | INo     | IYesI  |
| : | I _____ I    | :                   | I       | -----I      | -----I  | -----I  | -----I  | -----I |
| : |              | :                   | I       | 0-11 (K)    | IYesI   | IYesI   | IYesI   | IYesI  |
| : |              | I_:_ I D1           | I       | -----I      | -----I  | -----I  | -----I  | -----I |
| : |              | I_:_ I D2           | I       | 0-21 (M)    | IYesINo | IYesI   | IYesI   | IYesI  |
| : |              | I_:_ I D3           | I       | -----I      | -----I  | -----I  | -----I  | -----I |
| : |              | I_:_ I D4           | I       | 0-22 (M2)   | IYesINo | IYesINo | I       | I      |
| : |              | I_:_ I D5           | I       | -----I      | -----I  | -----I  | -----I  | -----I |
| : | _____        | I_:_ I D6           | I       | 0-71 (X)    | INo     | IYesINo | INo     | I      |
|   |              |                     | I       | -----I      | -----I  | -----I  | -----I  | -----I |
|   | Control unit |                     | I       | 2-71 (E)    | INo     | IYesI   | IYesI   | IYesI  |
|   |              |                     | I       | -----I      | -----I  | -----I  | -----I  | -----I |
|   |              |                     | I       | 2-72 (E2)   | INo     | IYesI   | IYesINo | I      |
|   |              |                     | I       | _____       | I       | I       | I       | I      |

Secret functions after modification

The following functions are added if you modify the destination. See the appropriate description for details.

Frequency range change

Change the diodes (D2, D3, D5, and D6) as shown in the destination column of Table 2.

#### Cross-band repeater

Remove D4 and press the F key for one second, then the 0 key, to turn this        function ON or OFF.       

#### Answerback function (during paging reception)

Hold down the Mhz key and switch the POWER ON to turn this function        ON or OFF.

#### 300-Mhz band AM/FM switching

Hold down the VFO key and switch the POWER ON to switch between AM and FM.       

#### VHF expansion band

Press the F key for one second, then the BAND key, to change the band.              

#### UHF expansion band

Press the F key for one second, then the BAND key, to change the band.              

#### Channel display mode

Hold down the 3 key and switch the POWER ON to change to frequency        display to the memory channel.  
# If you remove D1, only the channel is displayed. Normally, leave D1 # in.

#### Clone function

Hold down the 0 key and switch the POWER ON to use this function.       

#### Secret function available without modification. (Game function)

Hold down the M and PTT key and switch the POWER ON to use this function.              

#### Cross-band repeater

When one band becomes busy, the cross-band repeater function retransmits the received signal on the other band. As soon as the BUSY signal for the receiver band goes low, the transceiver enter receive mode on both bands.

Note 1: DTTS and paging are not checked.

Note Y: If TONE of the transmitter is on, a subtone is output.

Note 3: If the transmitter does not output a subtone, CTCSS is

checked.

### Cross-band repeater ON/OFF

You can turn the cross-band repeater ON and OFF by pressing the

F key for one second, then the 0 key.

The dot indicating Mhz on the frequency display (both bands) flashes while the cross-band repeater function is on.

Note 1: The cross-band repeater does not turn on during dual watch.

Note 2: If you enable the cross-band repeater when the bell function is on, the bell function is turned off and the cross-band repeater function is turned on. You can turn the repeater on only if the bell function for the operation band is off.

Note 3: A dedicated jumper is used to select whether to use the cross-band repeater.

Note 4: The timeout timer is set to three minutes.

### Cross-band repeater operation

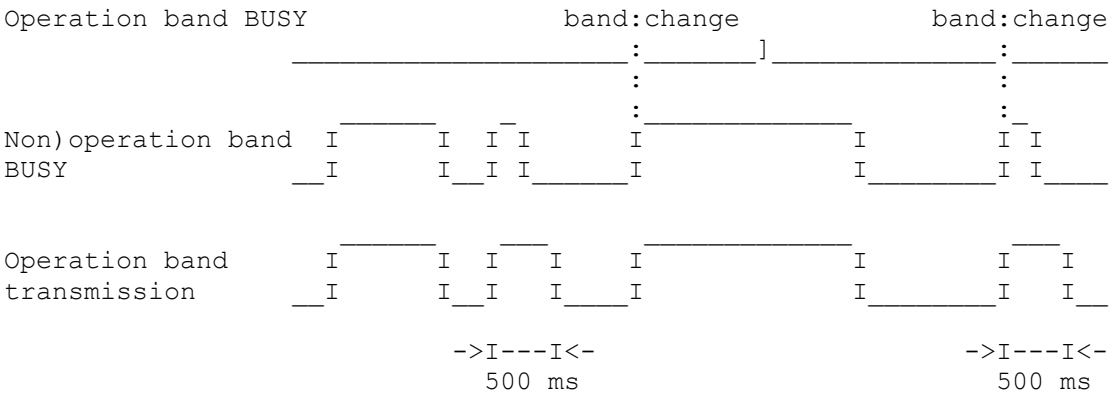

### Answerback function

If the transmitter pages a receiver, it does not know whether the receiver has received the paging signal. When the answerback function is ON, the receiver returns a code automatically if the paging code matches to indicate that it has received the paging signal. The transmitter can thus confirm that the code it sent was actually received.

### Operation

If the paging code matches and the busy signal goes low, the receiver returns a code. If the paging code does not match, the receiver does not return a code. The answerback function is related to the bell function: if you turn the bell function on when the answerback function is on, the answerback function works; If you turn the bell function off, the answerback function does not work. If the answerback function is off, only the bell function can be turned on or off. To turn the answerback function on and off, hold down the Mhz key and switch the POWER ON.

Mhz  
I

Note : This function is available only if reception is

modified.

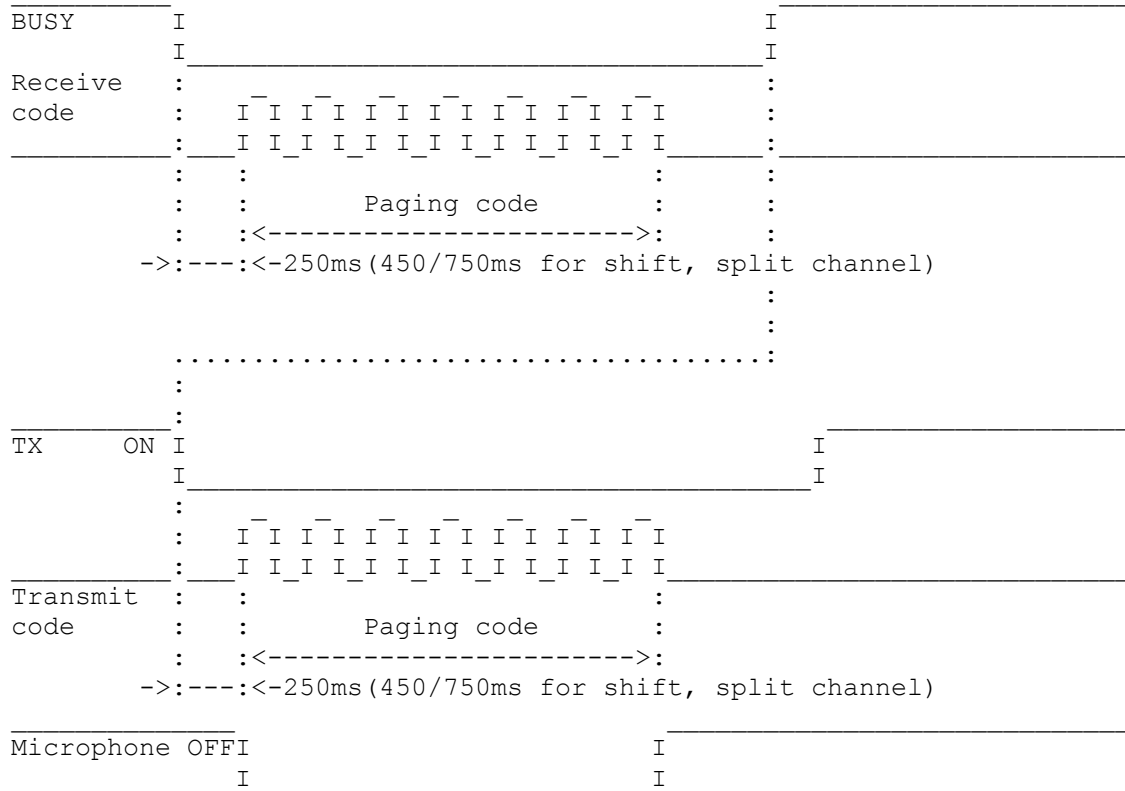

VHF expansion band

You can change the reception of AMATEUR band, AIR band, and POLICE band by pressing the \_\_\_\_\_ key for one second, then the \_\_\_\_\_



key, when the VHF band is VFO.

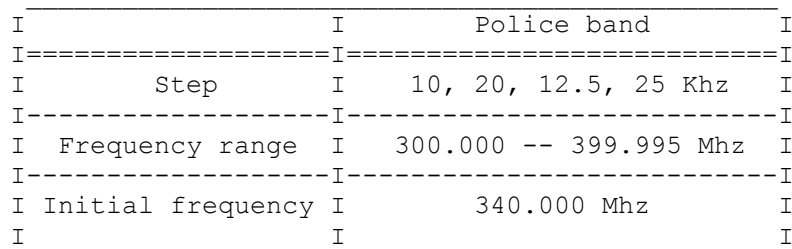

UHF expansion band

You can change the reception of AMATEUR band and CAR TELEPHONE band by pressing the \_\_\_\_\_ key for one second, then the \_\_\_\_\_ key,



when the UHF band is VFO.

|         |         |                                         |         |
|---------|---------|-----------------------------------------|---------|
| I       | I       | Car telephone                           | I       |
| I=====I | I=====I |                                         | I=====I |
| I       | I       | Step 12.5, 25 Khz                       | I       |
| I-----I | I-----I |                                         | I-----I |
| I       | I       | Frequency range 800.000 - 949.987.5 Mhz | I       |
| I-----I | I-----I |                                         | I-----I |
| I       | I       | Initial frequency 800.000 Mhz           | I       |
| I       | I       |                                         | I       |

Note 1:Program scan cannot be performed over bands. It can only be performed within each band.

Note 2:You cannot change the band in MR and CALL modes.

Note 3:The AIR band frequency range is shown below. It is contiguous in the VHF amateur band frequency range.

Note 4:The initial step is the same as the VHF amateur band step.

Note 5:If the AIR band is received as the UHF subband, FM reception is performed.

Note 6:The step is the same as the VHF band step.

|         |         |                                      |         |
|---------|---------|--------------------------------------|---------|
| I       | I       | Air                                  | I       |
| I=====I | I=====I |                                      | I=====I |
| I       | I       | Step 5, 10, 15, 20, 12.5, 25 Khz     | I       |
| I-----I | I-----I |                                      | I-----I |
| I       | I       | Frequency range 50.000 - 135.995 Mhz | I       |
| I       | I       |                                      | I       |

Channel display mode

Select the channel mode by cutting D1 on the CONTROL UNIT.

If you cut D1 on the CONTROL UNIT, you can use channel display mode only. You cannot change it to normal display mode from the panel.

If you do not cut D1 on the CONTROL UNIT, you can change between channel display mode and normal display mode by holding the key and switch the POWER ON.

I 3 I  
I I I

Note :Memory channels for both bands must contain frequencies. If nothing is stored in memory, an error occurs.

-----

Have fun...

Bye





From : WB1E @ K1RQG.ME.USA.NA  
To : MODS @ ALLUS  
Date : 921007/0128  
Msgid : BF 3616@K1RQG  
Subject: KENWOOD TH-78A MOD WARNING

In the course of performing mods on my Kenwood TH-78A dual band handheld, I've discovered a potential flaw in the case design. While handling my walkie one day (after the mods were done), the display went blank and I could not turn the radio back on. With the radio split in half again, I could turn the radio back on but discovered all the memories were erased. The cause turned out to be some component pins on the front face coming in contact with the square bodies of the two volume/channel/squelch switches, when the case is screwed back together snugly. I placed small strips of electrical tape on the sides of the switches to insulate, and reassembled; problem solved. Now I have to reprogram the darn thing....

Mark WB1E @ K1RQG.ME



Date: 13 Mar 89 16:07:03 GMT  
From: oliveb!pyramid!prls!philabs!briar.philips.com!rfc@apple.com (Robert Casey;6282;3.57;\$0201)  
Subject: tiny-2 tnc fix

copied from packet:

| Msg#  | TSP | Size | Read To | @ BBS | From  | Date/Time |
|-------|-----|------|---------|-------|-------|-----------|
| 25853 | BN  | 1240 | 0 ALL   |       | N2EZG | 8903/1617 |

Subject: Paccomm Tiny-2 Factory Mod

Here is the "Factory" fix for Pac-Comm Tiny-2's & Micro-Power 2's that have become hard of hearing. It seems that Pac-Comm has some boards out that work fine when new, but with age the tnc requires a huge amount of Audio input from the speaker jack or it won't decode properly. They are lost as to what is deteriorating in the boards but offer this fix to its customers.

It is quite simple and very neat, all parts are mounted on the under-side of a 16 pin IC socket, the Modem chip TCM3105 (U16) is removed, the modified socket is inserted into existing socket on TNC's board, and the modem chip is re-installed.

Parts Needed:

- 1 - 16 pin IC socket
- 1 - 2222 Transistor NPN (EGC 123AP)
- 2 - 10000 ohm 5% resistors (brown-black-orange-gold)

Instructions:

- Solder 1 resistor to Emitter, other end of resistor to pin 12
  - Solder 1 resistor to Base, other end to pin 2
  - Solder collector to pin 5
- >EndFile<



From: wa2ise@cbnewsb.cb.att.com (robert.f.casey)  
Newsgroups: rec.radio.amateur.misc  
Subject: TM221a, no TX in high power mode fix  
Keywords: fix  
Message-ID: <1991Dec10.045531.26853@cbfsb.att.com>  
Date: 10 Dec 91 04:55:31 GMT  
Sender: news@cbfsb.att.com  
Organization: AT&T Bell Laboratories  
Lines: 36

copied from packet:

| Msg# | TSF | Size | #Rd | Date   | Time | From  | MsgID        | To             |
|------|-----|------|-----|--------|------|-------|--------------|----------------|
| 8736 | BF  | 1141 | 0   | 07-Dec | 0512 | KD2EJ | 28379_WB2QJA | INFO@ALLBBS () |

Sb: TM-221 NO HIGH PWR TXMT.

SB-933

TM-221A No TX in High Power Due to Voltage Drop 4-11-88

Some TM-221A transceivers may intermittently not transmit in the high power mode. This condition may be the result of a voltage drop at the fuse terminals on the power cord. To prevent a voltage drop, solder the terminals by following the procedure below.

- 1 Disconnect the antenna and power supply.
- 2 Open and remove the plastic fuse holder.
- 3 Remove the fuse from the terminals.
- 4 Flow solder between the terminals and the exposed strands of the cable.
- 5 Allow the terminals to cool and then reinstall the fuse and close the holder.

This modification may be covered under warranty.  
Time required for this modification is 0.24 hrs or less.  
(c) 42788TKC

=====  
Note: I haven't tried or verified this, proceed at your own risk. WA2ISE



From: wa2ise@cbnewsb.cb.att.com (robert.f.casey)  
Subject: TM421a TX mod file  
Date: 19 Oct 91 03:23:18 GMT  
Sender: news@cbfsb.att.com  
Organization: AT&T Bell Laboratories  
Lines: 30

copied from packet:

| Msg#                   | TSF | Size | #Rd | Date   | Time | From  | MsgID       | To             |
|------------------------|-----|------|-----|--------|------|-------|-------------|----------------|
| 63056                  | BF  | 1307 | 1   | 14-Oct | 1645 | N2FWQ | 49200_N2IMC | MODS@ALLBBS () |
| Sb: knwood tm421a mods |     |      |     |        |      |       |             |                |

This mod is only intended for experimental applications only! Know what freq you are on and don't use this mod if you are not for sure. The TM-421a is capable of transmitting from 136 to 174 MHz when the following modification is performed. The transmitter specifications will vary from published in-band specifications.

1. Remove the top and bottom covers from the transceiver.
2. Remove the knobs from the front panel.
3. Remove the nut from the mic jack and the nut from the channel selector switch.
4. Remove the 4 screws that secure the front panel to the body of the transceiver
5. Pull the front panel off the transceiver to expose the Control board.
6. Remove the 3 screws from the Control board. Gently pull the board off the transceiver.
7. Cut the GREEN jumper wire on the Control board.
8. Install an MA141A chip diode or 1N914 diode as D209 on the Control Board.
9. Reassemble the transceiver by reversing steps 1 - 6.
10. Reset the microprocessor by holding in the MR key as power is turned on.

---

I haven't tried or verified this, proceed at your own risk. WA2ISE  
And do not transmit outside of legal bands!





Date: Wednesday, 5 June 1985  
From: (unknown)  
Subject: TM-2530/2550/2570 MARS/CAP

The TM-2500 series radios may be easily modified for use on MARS/CAP frequencies from 141-150.995mhz.

Locate the control unit (X54-1860-XX) on the bottom of the radio. This is the same board that the TU-7, and or MU-1 are mounted on. Just to the left of IC3 you will find a row of diodes. Cut diodes D8, and D11. After the diodes have been cut you will have to "reset" the microprocessor.

Microprocessor Reset.

1. Press and hold the [PS] key.
2. Turn ON the power switch.
3. Release the [PS] key.

All of your programmed data such as memory channel data, DCL data, and Phone number data will be erased and you will have to reprogram them. If the radio is not reset, it will not recognize that you have cut the two diodes.



Subject: TM-2530/2550/2570 MARS/CAP

The TM-2500 series radios may be easily modified for use on MARS/CAP frequencies from 141-150.995mhz.

Locate the control unit (X54-1860-XX) on the bottom of the radio. This is the same board that the TU-7, and or MU-1 are mounted on. Just to the left of IC3 you will find a row of diodes. Cut diodes D8, and D11. After the diodes have been cut you will have to "reset" the microprocessor.

Microprocessor Reset.

1. Press and hold the [PS] key.
2. Turn ON the power switch.
3. Release the [PS] key.

All of your programmed data such as memory channel data, DCL data, and Phone number data will be erased and you will have to reprogram them. If the radio is not reset, it will not recognize that you have cut the two diodes.



Date: Mon, 25 Sep 89 14:38:05 EDT  
From: rfc@philabs.Philips.Com (Robert Casey)  
To: mbramwel@uwo.ca

Subject: TM321A Mars/cap mod  
from WM8J msgID 2846\_wa2rkn

To give the TM321 tx coverage from (142 Or 143, don't remember which) to 151.995 mhz, remove the top cover. Look for a loop of wire coming from the display area (the board with the CPU) and going right back. Cutting this wire and then doing a CPU reset is all you need to do. Takes about 2 minutes. Be sure that the ends of the wire don't short to something.

73s

Note: I haven't tried this, proceed at your own risk! WA2ISE



Subject: TM321a weak mic audio fix  
Message-ID: <62440@philabs.Philips.Com>  
From: rfc@briar.philips.com (Robert Casey;6282;3.57;\$0201)  
Date: 28 Aug 89 15:03:59 GMT  
Reply-To: WM8J@WA2SNA

| Msg#                         | TSP | Size | #Rd | Date/Time | MsgID       | From | To         |
|------------------------------|-----|------|-----|-----------|-------------|------|------------|
| 1740                         | BF  | 824  | 0   | 0827/0533 | 4206_WA2SNA | WM8J | ALL@ALLBBS |
| Sb: TM231/WEAK MIC AUDIO FIX |     |      |     |           |             |      |            |

A QUICK AND DIRTY FIX FOR THE KNWD TM231A LOW MIC OUTPUT: KNWD COMES OUT WITH A FIX WHICH IS TO BYPASS R 63 (3.3K). R 63 AND R64 FORM A VOLTAGE DIVIDER AT THE INPUT TO THE MIC AMP. R63 IS ON THE BOTTOM OF THE RIG. WITH THE BOTTOM COVER OFF AND THE FRONT OF THE RIG FACING YOU, LOCATE THE MIC AMP BOARD 3610 WHICH STANDS VERTICALLY OFF THE MOTHER BOARD. FOLLOW THE 3RD PIN FROM THE LEFT TO R63. A JUMPER HERE GIVES THE TX AUDIO A NICE BOOST. BE SURE TO READJUST THE DTMF OUTPUT IN THE MIC (THE ONLY POT IN THE MIC). 73 AND GOOD LUCK. GREG.

1951z, 473 msgs, #1786 last @KD6TH-4 MailBox>





To: mbramwel@uwo.ca  
Date: Wed, 8 Nov 89 10:24:00 est  
Subject: packet mod for TM321  
From: rfc@briar.philips.com (Robert Casey;6282;3.57;\$0201)  
Date: 5 Sep 89 14:37:21 GMT  
Sender: news@philabs.Philips.Com

Msg# TSP Size #Rd Date/Time MsgID From To  
2627 BF 1043 2 0904/0022 4650\_WA2SNA WM8J ALL@ALLBBS  
Sb: TM231PACKETMOD

THE FOLLOWING IS AN EASY MOD TO SQUELCH THE AUDIO AT MIC PIN 6 FOR  
TNC'S

WITHOUT TRUE DCD: OBTAIN FROM KENWOOD A 2SD1757(K) (SURFACE  
MOUNT TRANSISTOR). INSTALL EMITTER TO MIC PIN 8, COLLECTOR TO  
MIC PIN 6, AND JUMPER FROM BASE TO THE UNUSED PIN ON CONNECTOR  
202. USING THE UNUSED PIN RATHER THAN RUNNING THE JUMPER TO THE  
MOTHER BOARD PRESERVES THE PLUG IN FEATURE OF THE FRONT PANEL.  
CONNECT ONE END OF A 4.7 K RESISTOR (I USED A 6.8 K) TO THE  
MUTE LINE (IC 5 PIN 7), AND CONNECT THE OTHER END TO THE UNUSED  
PIN OF CONNECTOR 4, WHICH MATES WITH CONNECTOR 202. THIS NEW  
CIRCUIT IS A CLOSE COPY OF THE AF MUTE CIRCUIT THAT SQUELCHES  
THE RX AUDIO AT THE SPEAKER. IT WORKS PERFECT WITH MY PACCOMM  
MICROPOWER 2. THE HARDEST PART OF THE MOD IS REMOVING THE  
LOCKING RING AROUND THE MIC CONNECTOR. I USED A MODIFIED TABLE  
FORK! GOOD LUCK.

0241z, 939 msgs, #2643 last @KD6TH-4 MailBox>

Note: I haven't tried this, proceed at your own risk! WA2ISE



Article: 8742 of rec.radio.amateur.misc  
From: wa2ise@cbnewsb.cb.att.com (robert.f.casey)  
Newsgroups: rec.radio.amateur.misc  
Subject: TM421a TX mod file  
Keywords: mods  
Message-ID: <1991Oct19.032318.5688@cbfsb.att.com>  
Date: 19 Oct 91 03:23:18 GMT  
Sender: news@cbfsb.att.com  
Organization: AT&T Bell Laboratories  
Lines: 30

copied from packet:

| Msg#  | TSF | Size | #Rd | Date   | Time | From  | MsgID       | To             |
|-------|-----|------|-----|--------|------|-------|-------------|----------------|
| 63056 | BF  | 1307 | 1   | 14-Oct | 1645 | N2FWQ | 49200_N2IMC | MODS@ALLBBS () |

Sb: knwood tm421a mods

This mod is only intended for experimental applications only! Know what freq you are on and don't use this mod if you are not for sure. The TM-421a is capable of transmitting from 136 to 174 MHz when the following modification is performed. The transmitter specifications will vary from published in-band specifications.

1. Remove the top and bottom covers from the transceiver.
2. Remove the knobs from the front panel.
3. Remove the nut from the mic jack and the nut from the channel selector switch.
4. Remove the 4 screws that secure the front panel to the body of the transceiver
5. Pull the front panel off the transceiver to expose the Control board.
6. Remove the 3 screws from the Control board. Gently pull the board off the transceiver.
7. Cut the GREEN jumper wire on the Control board.
8. Install an MA141A chip diode or 1N914 diode as D209 on the Control Board.
9. Reassemble the transceiver by reversing steps 1 - 6.
10. Reset the microprocessor by holding in the MR key as power is turned on.

---

I haven't tried or verified this, proceed at your own risk. WA2ISE  
And do not transmit outside of legal bands!



Path: njitgw.njit.edu!dorm.rutgers.edu!rutgers!cs.utexas.edu!qt.cs.utexas.edu!  
zaphod.mps.ohio-state.edu!pacific.mps.ohio-state.edu!linac!att!cbfsb!  
cbnewsb.cb.att.com!wa2ise  
From: wa2ise@cbnewsb.cb.att.com (robert.f.casey)  
Newsgroups: rec.radio.amateur.misc  
Subject: TM421a TX mod file  
Keywords: mods  
Message-ID: <1991Oct19.032318.5688@cbfsb.att.com>  
Date: 19 Oct 91 03:23:18 GMT  
Sender: news@cbfsb.att.com  
Organization: AT&T Bell Laboratories  
Lines: 30

copied from packet:

| Msg#                   | TSF | Size | #Rd | Date   | Time | From  | MsgID       | To             |
|------------------------|-----|------|-----|--------|------|-------|-------------|----------------|
| 63056                  | BF  | 1307 | 1   | 14-Oct | 1645 | N2FWQ | 49200_N2IMC | MODS@ALLBBS () |
| Sb: knwood tm421a mods |     |      |     |        |      |       |             |                |

This mod is only intended for experimental applications only! Know what  
freq you are on and don't use this mod if you are not for sure.  
The TM-421a is capable of transmitting from 136 to 174 MHz when the following  
modification is performed. The transmitter specifications will vary from  
published in-band specifications.

1. Remove the top and bottom covers from the transceiver.
2. Remove the knobs from the front panel.
3. Remove the nut from the mic jack and the nut from the channel selector  
switch.
4. Remove the 4 screws that secure the front panel to the body of the  
transceiver
5. Pull the front panel off the transceiver to expose the Control board.
6. Remove the 3 screws from the Control board. Gently pull the board off  
the transceiver.
7. Cut the GREEN jumper wire on the Control board.
8. Install an MA141A chip diode or 1N914 diode as D209 on the Control  
Board.
9. Reassemble the transceiver by reversing steps 1 - 6.
10. Reset the microprocessor by holding in the MR key as power is turned  
on.

---

I haven't tried or verified this, proceed at your own risk. WA2ISE  
And do not transmit outside of legal bands!



From: "SURESH KAGOO (N9GSA)" <SKAGOO@MEMSTVX1.bitnet>  
 Subject: TM701A CROSSBAND MOD

TM-701A REPEATER CROSS-BAND MODIFICATION (REVISED)

This Mod is from KENWOOD

Perform The following modification to allow the TM-701A to operate in the repeater cross-band mose.

MODIFICATION:

1. Disconnect the power supply and antenna.
2. Remove the top and bottom covers (12 screws). Disconnect the speaker wire from the transceiver.
3. Locate the green jumper wire shown in figure 1. Using a sharp pair of wire cutters, cut the jumper in half.

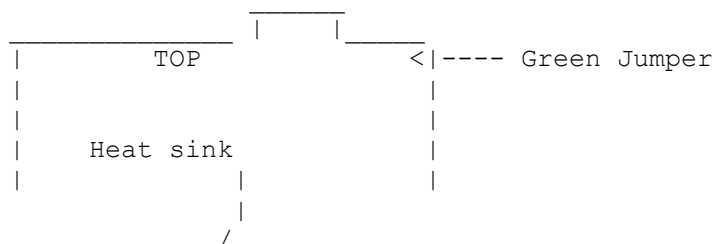

FIGURE 1

CAUTION: Cutting the green jumper allows the TM-701A to transmit from 142 to 151.995 MHz. Protect your license by only using frequencies that you are authorized to transmit on.

4. Solder a jumper wire to the foil side of the TX-RX board as shown in Figure 2.

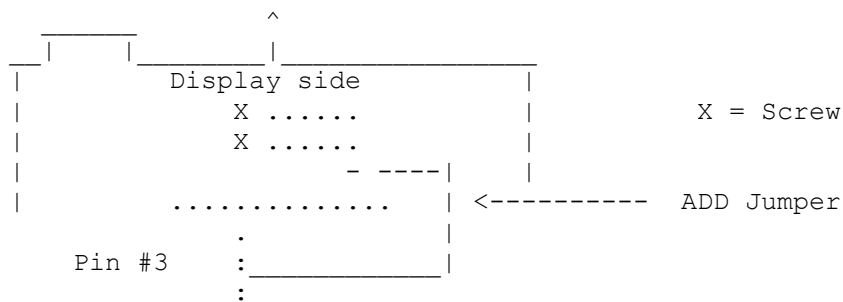

FIGURE 2

5. Assemble the transceiver by reversing steps 1-2.
6. Reset the microprocessor by holding in the MR key as the power is turned on.



The repeater cross-band operation allows the TM-701A to receive on one band and re-transmit the signal on the other band. The TM-701A alternately displays the two bands until a signal is received. The transceiver will then display the band that is re-transmitting the signal. The shift function cannot be used during the repeater cross-band operation. If the TONE or CTCSS function is required, only one EIA tone can be used for the two bands.

OPERATING PROCEDURE:

1. Select the operating frequencies for both bands.
2. Set the squelch control to the threshold point. The TM-701A will transmit in the repeater cross-band mode if the squelch control is set too low or a signal is received.
3. Place the transceiver in the duplex mode (F + DUP).
4. Press the F key for longer than one second. The F indicator will flash.
5. Press the LOW key. The transceiver will now enter the repeater cross-band mode of operation.
6. To cancel the operation and return to the VFO mode, press the VFO key.



Subject: Kenwood TM701A mods  
From: chris@hplvli.HP.COM (Chris Kelly)  
Date: 24 Jul 89 15:35:10 GMT

The TM-701 has a green loop of wire protruding from the front panel PC board into the main area of the radio. Clip this wire to gain TX up to 151.995 MHZ.

73 de WD5IBS



Date: Sun, 11 Dec 88 02:58:24 EST  
Subject: TM721 modification  
Cc: ve3pzr@uwo.ca

The TM721 modification is very EASY. Here is the information :

Chip resistor R121 on the Control Unit must be removed. Here is how.

1. Disconnect power and antenna
2. Remove the top and bottom covers (12 screws)
3. Remove the silver coloured screws from the front panel chassis.  
(2 on each side, 1 on top, 1 on bottom)
4. Pull front panel away from the radio but DO NOT disconnect cables.
5. Locate chip resistor R121 on the Control Unit and desolder.  
When looking at the Control Unit, you will see the lithium battery located to the left of centre and the power switch sub-assembly located on the bottom right. Look at the centre of the lithium battery and you will see R121 located down and to the left of the battery close to the bottom edge of the board about 3/4" left of centre of the battery. Remove this chip resistor.
6. There is also a 3 minute time-out timer that will place the radio into the receive mode after 3 minutes of continuous transmit. I removed mine and I will describe the location of R122 which defeats the timer. If you look again at the lithium battery, look at the bottom edge of the battery and then over to the right about 1 inch from the bottom centre of the battery and you will come across an upper set of 2 resistors and below that another set of 5 resistors (chip type). Remove the first resistor (left one) in the upper set.

#### OPERATION

Repeater cross-band operation allows the 721 to receive on one band and retransmit the signal on the other band. An incoming signal will automatically be switched to the subband. The 721 will then retransmit the signal from the main band. Each band may contain offset and subaudible tone information with the tsu-6 tone board. The encode and decode tones for a single band must be the same. Each band may contain a separate sub-audible tone frequency.

1. Select the first frequency in the main band and select a repeater offset if desired.
2. Select TONE if needed.
3. Press the BAND key to transfer contents of MAIN into SUB.
4. Select the second frequency and if desired a CTCSS tone.
5. Adjust the main and sub band squelches to the threshold.

#### ENABLING CROSS BAND REPEATER

1. Press the F (orange function) key
2. Press the A.B.C. key within 5 seconds of step 1  
Three dots will light in the decimal place locations in the MAIN band.

The repeater will always transmit out of the main band. I will give you an

example of accessing a 70cm repeater with a 2m handheld on a simplex freq.  
Desired repeater RX 444.8 TX 449.8 2m 145.54

In main band enter 145.54 and press BAND key to transfer to sub display.  
Enter 444.8 with + offset. Press F + A.B.C.

Key up simplex handheld and you will see the sub-band receive your frequency  
and at the same time you will see the main band key up and transmit on  
449.8 Mhz.

Release the simplex PTT on the handheld and the radio will quickly flip  
145.54 into the MAIN band and 444.8 into the sub-band. The 70cm repeater  
will be transmitting to your radio in the sub-band at 444.8 and the 721  
will be transmitting out of the MAIN band on 154.54.

Neat stuff !!!! Warning, disconnect your mic or be quiet and DOUBLE WARNING  
DO NOT PUT A 2M repeater in the MAIN and a 70CM in the sub or they will  
continually key up each other back and forth through the 721. Also note that  
when the 721 is transmitting on the MAIN band out to your 2M simplex radio  
and receiving a signal from the 70cm repeater, you will not be able to gain  
control of the transmitter of your 721 until the 70 cm tail drops as the  
radio does not sample the incoming audio for a carrier while transmitting.

The mod is neat and if you disable the tail timer on your 70 cm repeater, this  
works great in situations where a hand held ( 1 watt) cannot access the 2M  
repeater.

Enjoy and RSVP with any further questions or concerns.



From: flloyd%crank@Sun.COM (Fred Lloyd)  
Newsgroups: rec.ham-radio  
Subject: Re: Kenwood TM-621,721 mods ?  
Date: 25 Apr 89 21:43:28 GMT  
Reply-To: flloyd@sun.UUCP (Fred Lloyd)

>As I was doing the cross-band repeater mod ( you  
>might consider it a simplex range extender) it seems  
>that there are several other 0 ohm surface mount  
>resistors (shorts) grounding several other pins  
>on the microprocessor. Does anyone know what other  
>undocumented features these units have?

The programming resistors do the following:

1. Select the European frequency bands (430 - 440)
2. Select MARS/CAP xmit freqs (141 - 150)
3. Select unrestricted out-of-band xmit (add a jumper)
4. Select cross-band repeater mod
5. Disable built-in 3 minute timeout timer for crossband repeater.

Number 1 was easy, I just installed a jumper where there were a pair of empty pads next to a row of four or five other 0 ohm (jumper) "resistors". I found this quite useless and promptly removed it.

Number 2 is also very easy, but unnecessary for 90% of us. If you need MARS/CAP then you'll be able to get the details from Kenwood.

Number 3 is somewhat of a mystery as I've been told the jumper position but have been unable to find it on the board. My interest was in opening up the UHF receive to hear the public service channels. Unfortunately, this mod opens up transmit as well, on both bands and apparently without restriction (as the gossip goes).

Number 4 is real easy and involves removing the resistor marked R121 on the schematic.

Number 5 is also easy and just remove R122 to do it. (I haven't though)

What I'd like to know concerns the remote control capabilities that are available through the microphone plug. From looking at the manual, it's clear that when the RC-10 remote control handset is used, many of the radio's front panel controls are made remotely available. Does anybody know the manner in which the three data pins on the mike plug are used for this. The three pins are PTT, UP and DOWN (in normal mode). Presumably, there is a way to communicate with the onboard microprocessor using these pins. If so, then somebody could conceivably use their PC to control the radio.

Inquiring minds want to know....

Any Ideas?



-fred

---

|                                              |               |
|----------------------------------------------|---------------|
| Fred Lloyd KJ6RK PP-SEL                      | floyd@sun.com |
| Sun Microsystems, Inc.                       | ...sun!floyd  |
| Mountain View, CA                            |               |
| (415) 336-6322                               |               |
| Disclaimer: If it ain't broke, don't fix it! |               |

---



Date: Mon, 8 May 89 11:42:21 PDT  
From: flloyd@Sun.COM (Fred Lloyd)  
To: MBRAMWEL@uwo.ca  
Subject: TM-721A UHF Extend Mod

## Modifying the Kenwood TM-721A for Extended UHF Coverage

Well I finally uncovered the specifics of the mod which will extend the UHF coverage of the TM-721A. This mod changes the UHF receive from it's factory setting of 438 - 449.995 mhz to approximately 420-460 MHZ. There are some peculiarities surrounding this mod so I'll describe them first.

First of all, this mod will allow the UHF digital display to traverse from 400.000 to 499.995. The radio will not, however, tune this entire range due to a combination of a limited synthesizer lock range and the input RF amplifier bandwidth. The apparent useful tuning range is about 420-460, with sensitivity dropping off sharply at either end. Naturally, the best performance is in the middle (the Ham Band :-).

Similarly, the VHF tuning range is extended in the same manner. After the mod is made, the VHF side will apparently tune from between 100-199 mhz but as stated above, there is little or no response outside of the published range (138-170 mhz), due to the same reasons as stated above.

As a final side effect, note that performing this mod will remove all out-of-band transmit restrictions on the rig, for both VHF and UHF. After the mod is in place, the radio will transmit on any frequency that it can tune to.

### DISCLAIMER:

The author of this report wishes to strongly remind those who perform this mod that it is ILLEGAL to transmit on any frequencies outside of the ham bands, EVEN IF YOU ARE OTHERWISE LICENSED TO DO SO. This is because of the radio's lack of FCC type acceptance for these frequencies. So beware! Unauthorized use of this feature could be hazardous to your ticket. MARS/CAP users are probably OK with a permit.

Now for the nuts and bolts.....

### MODIFICATION PROCEDURE

1. Turn the radio on and write down all of your memory channel frequency assignments, PL codes and anything else you have in memory - It will all have to be reprogrammed after the mod. After writing down all of your data, turn off the unit and disconnect it from the antenna and power supply.
2. Next, remove the bottom cover on the unit. Note: this radio contains a number of CMOS parts which could be damaged by static

discharge. Take all of the regular precautions to make sure that you and your tools are properly grounded for anti-static work. Note that there is a hole in the rear of the subchassis which supports the controller circuit board in which you can see a small, black, 1/4 watt resistor which is labeled on the board as R57. Using a small pair of sharp cutters, clip the lead on the end of the resistor. It is not necessary to remove the part, just clip one end and bend it slightly out of the way.

2. Next, remove the top cover and then open the front panel assembly into the service position. To do this, remove the four silver screws, one on the top, one on the bottom, and one from each side. Two of the screws are in slotted holes. Loosen the screws in the slotted holes slightly so as to allow the front panel to be pulled out and swung down in a hinge-like fashion. Once open, set the radio on a table with the hinged front panel hanging over the edge of your workbench. Familiarize yourself with the inside of this compartment. The most notable features are a silver, button type lithium battery to the left of center and a large, multi-pin microprocessor chip on the right. DO NOT DISCONNECT ANY OF THE RIBBON CABLES.

3. Locate the lithium battery and to it's left you will notice a row of five programming resistor positions, with the middle position vacant. The arrangement looks something like this:

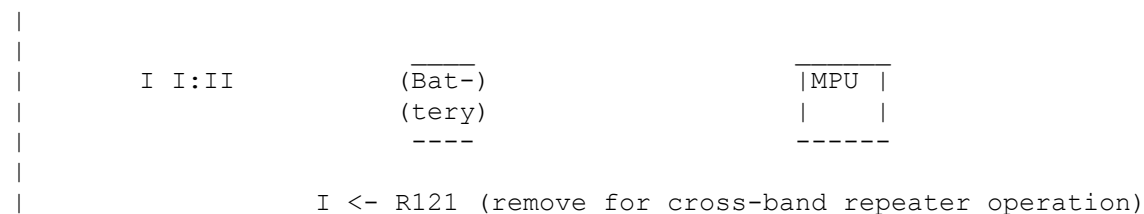

---

VVV front of rig VVV

The (:) above indicates where a jumper is to be placed. Use care in soldering since everything is quite small.

4. Reassemble the unit in the reverse order as described above. When you power the rig up, the display should show 440.000 and 144.000 on the displays. It is now ready for operation. If necessary, perform the microprocessor reset function by holding down the F button while turning on the power. Reprogram the unit with the data you saved in step 1.

Comments:

There is nothing special about operating the rig once the modification is made. All functions operate exactly as before except that the range on each band is extended as described above. You will probably want to program the band scan limiting channels (A and B) on both bands since otherwise your vfo scanning will be too broad and will spend a lot of time scanning in areas which it cannot receive.

In addition, my rig also has the cross-band repeater mod. I do not

know if having this is a prerequisite to performing the mod mentioned above. If it is, then R121 will also have to be removed. The cross-band repeater mod has already been discussed on the net so I won't go into it at this time.

Enjoy this mod but don't endanger your license! Don't transmit out of band and don't allow others to, even if they're licensed for those frequencies!

-fred

---

|                                              |               |
|----------------------------------------------|---------------|
| Fred Lloyd KJ6RK PP-SEL                      | floyd@sun.com |
| Sun Microsystems, Inc.                       | ...sun!floyd  |
| Mountian View, CA                            |               |
| (415) 336-6322                               |               |
| Disclaimer: If it ain't broke, don't fix it! |               |

---



Date: 16 Sep 89 11:26  
Message-ID: <7602@VE3WZL>  
From: VE3WZL@VE3WZL  
To: ALL@VE3GYQ  
Subject: TM-731A RPTR & OUT-OF-BAND MODS  
Path: N8HTG!VE3WZL

Thanks to the efforts of our local technical wizard, Bob VE3GVD, we now have the secret to making the new Kenwood TM-731A do the same fancy tricks that its sister rig the TM-721A did. Here is how it's done:

- 1) Remove the top and bottom covers, and take out the screws that will allow the front panel assembly to swing down.
- 2) With the rigs front facing you and the top side up, locate R 121 and R 125 which are both immediately to the left of the lithium battery.
- 3) Using a low wattage iron and tweezers, remove R 121 which is about the seven o'clock position with respect to the battery and reinstall it in the blank position designated for R 125 which is about the eight-thirty position with respect to the battery.
- 4) Now locate R 25 on the back of the circuit board that is attached vertically to the main chassis. (It's the board behind the front panel when the panel is folded up) Carefully un-solder and lift off the grounded end.

That completes the mod. Having a service manual, or at least a board layout will assist you in locating the components. It will be necessary to do a reset on the microprocessor as described in the user manual after doing the mods described.

For those curious as to what does what, removing R 121 enables the repeater cross-band function, and the adding of R 125/removal of R 25 enables the out-of-band features.

73, Weazle, VE3EAR @ VE3WZL.ON.CAN.NA





From: flloyd@L1-A.West.Sun.COM (Fred Lloyd [Phoenix SE])  
Newsgroups: rec.radio.amateur.misc  
Subject: Kenwood TM-732A Extended Receive Mod  
Message-ID: <kv5sdhINNkrp@west.west.sun.com>  
Date: 20 Apr 92 16:30:41 GMT  
Organization: Sun Microsystems, Phoenix, AZ  
Lines: 29  
NNTP-Posting-Host: l1-a.west.sun.com

Extended Receive Mod for the Kenwood TM-732A Dual Bander

1. Unclip removable control head unit (leave wire attached).
2. Open small plastic trap door in back of control head.
3. Cut small green wire.
4. Reassemble, apply power.

This mod extends the UHF receive to 410-570 MHz. Receiver works over full 410-570 Mhz range.

This mod also enables an 800 Mhz receive mode. To use, place radio in VFO mode and push and hold MHZ key.

Note: My radio hears nothing at 800. I suspect that a separate antenna connection must be made.

73, Fred, AA7BQ

--

|                                             |                         |
|---------------------------------------------|-------------------------|
| Fred Lloyd AA7BQ, Systems Engineer          | Fred.Lloyd@west.sun.com |
| Sun Microsystems Computer Corporation       | ...sun!flloyd           |
| Phoenix, AZ (If it's a fact, I believe it!) | (602) 275-4242          |



From: flloyd@L1-A.West.Sun.COM (Fred Lloyd [Phoenix SE])  
 Newsgroups: rec.radio.amateur.misc  
 Subject: TM-732A MODIFICATION MATRIX  
 Date: 27 Apr 1992 22:10:57 GMT  
 Organization: Sun Microsystems, Phoenix, AZ  
 Lines: 145  
 Distribution: world  
 Message-ID: <kvouvhINNdq2@west.west.sun.com>  
 NNTP-Posting-Host: l1-a.west.sun.com  
 Summary: All Band Mods

MODIFICATION MATRIX FOR THE KENWOOD TM-732A

| M  | Resistors |    |    |    | TX Ranges |         | STD     | Has      | Remarks                        |
|----|-----------|----|----|----|-----------|---------|---------|----------|--------------------------------|
|    | 22        | 21 | 20 | 19 | VHF       | UHF     | SHIFT   | 800      |                                |
| K1 | 0         | 1  | 0  | 1  | 144-148   | 438-450 | .6/5    |          | Std. US Version                |
| K2 | 1         | 1  | 0  | 1  | 144-148   | 438-450 | .6/5    | x        | US After green wire cut        |
| K3 | 1         | 0  | 0  | 1  |           | 142-152 | 420-450 | .6/5     | x MARS/CAP Mod                 |
| K4 | 0         | 1  | 1  | 0  |           | 136-174 | 410-470 | .6/5     | x All Band Mod                 |
| M1 | 0         | 0  | 0  | 0  | 144-148   | 430-440 | .6/5    |          | Generic Int'l Model            |
| M2 | 0         | 1  | 0  | 0  |           | 136-174 | 410-470 | .6/5     | x All Band Int'l (430 default) |
| E1 | 0         | 0  | 1  | 0  |           | 144-146 | 430-440 | .6/(1.6) | Std Europe Model               |
| E2 | 1         | 0  | 1  | 0  |           | 136-174 | 432-438 | .6/1.6   | x Denmark                      |
| E3 | 0         | 0  | 1  | 1  |           | 144-146 | 410-470 | .6/(1.6) | x                              |
| E4 | 1         | 1  | 0  | 0  |           | 144-146 | 430-440 | .6/(1.6) | x                              |
| E5 | 1         | 0  | 1  | 1  |           | 136-174 | 410-470 | .6/(1.6) | x Europe All Band              |
| C1 | 0         | 0  | 0  | 1  |           | 136-174 | 340-512 | 5.7/10   | China Model                    |

0 = Resistor IN      1 = Resistor OUT

Notes:

1. All "resistors" 0 ohms (wire jumper OK)
2. Green wire is equivalent to R22 - present in K1 model
3. 0 = resistor present, 1 = resistor absent
4. Standard shifts in MHz VHF/UHF. Those listed as (1.6) also do -7.6
5. Codes not listed are used in Japan version, special CPU required
6. M column is factory MODE number
7. K2 Mod includes 410-470 RECEIVE and enables CLONING features

To perform any of these mods, remove the back cover from the remote head unit. Resistor numbers clearly marked on board along top.

800 MHZ RECEIVE

To enable 800 receive, switch to UHF VFO (not available in UxU), press and hold MHZ button until 800.000 appears.

A capacitor must be added (C348) to enable the 800 receiver. To add, remove UHF transciever board and next to the pad of pin 1 of IC-202 (on the foil side), add a 2.2 pF chip capacitor. A wire can be used instead of the capacitor but sensitivity will

be reduced. (See schematic diagram for reason).

#### HARD-WIRE CLONING (Works in all configuration modes)

This procedure allows you to clone the entire memory of a "master" transceiver into the memory of a "slave" transceiver.

First, construct an RJ-45 Jumper cable as follows:

```
-----|                               |-----
      UP ----- UP                    Note that PTT and DOWN
      E ----- E                      are crossed end-to-end
      PTT ----- DOWN
      DOWN ----- PTT
-----|                               |-----
```

For hacker's reference: UP=CLK, PTT=SO/, DOWN=SI

1. Configure the master transceiver's memories as desired.
2. Switch power OFF, hold down F and MHZ keys and switch power back on while holding keys. Display will show "CLonE".
3. Set the slave transceiver in the clone mode (as in step 2).
4. Plug the cable into the two radios (which end does not matter).
5. Press the CALL button on the master. When "End" is displayed, operation is complete.

#### ON AIR CLONING (Does not work in K1 or E1 Mod modes)

This procedure allows you to clone a second transceiver as above, over the air. The data is transmitted automatically using DTMF tones. During transmission (which is one-way only), the master will automatically switch to LOW power. To be legal, use only a UHF cloning frequency.

This procedure is not enabled in the stock transceiver. At a minimum, you must cut the green wire to make it work.

1. Configure master transceiver's memories as desired. Select a UHF simplex transmit frequency and set PTT to UHF (will work on VHF but is not recommended).
2. Switch the power OFF. Press and hold the CALL and DTSS buttons and turn the power back ON. "CLonE" appears in display.
3. Set the receive frequency on the slave transceiver the same as that of the master. Turn power OFF, hold down CALL and DTSS keys and turn power ON. "CLonE" appears in display.
4. Press the PTT on the master's microphone. Data transmission will begin. In case of a receive error, the slave transceiver will display "Err". When the procedure is complete, both radios will

display "End".

THE FOLLOWING FEATURES ARE UNVERIFIED, SO  
YOU MAY NEED TO EXPERIMENT FOR YOURSELF

PAGING ANSWERBACK (Does not work in K1 or E1 Mod modes)

The exact operation of this feature is unclear but the following  
description has been given:

1. To enable, hold down the F key and press the TONE key.
2. Do disable, repeat step 1

When enabled, documentation says: "If a matching code is received  
and the other transceiver is no longer BUSY, the code of the local  
transceiver is sent to the other transceiver. The answerback  
function then turns off."

MEMORY RECOVERY (requires DTMF microphone)

(Documentation of this "feature" is difficult to comprehend but  
perhaps someone will figure out what it does.. I suspect that  
"RECOVERY" refers to returning the memories to their original  
state after changing the split memory layout.)

1. Hold down F and C.SEL, turn on power
2. Press D, followed by 7 on the microphone. "Inspection Mode"  
is now enabled.
3. To cancel, press and hold F and then C.SEL

"Note: Before recovery, the memory channels must be returned to  
the previous state (number of split memories, etc.)."

--

```
| Fred Lloyd AA7BQ, Systems Engineer          Fred.Lloyd@west.sun.com |
| Sun Microsystems Computer Corporation      ...sun!flloyd |
| Phoenix, AZ      (If it's a fact, I believe it!)      (602) 275-4242 |
```



From: flloyd@L1-A.West.Sun.COM (Fred Lloyd SUN Phoenix SE 602-275-5537 x17)  
Newsgroups: rec.radio.amateur.misc  
Subject: TM-741 Mod  
Summary: All-Band mod for new Kenwood Tri-Bander  
Message-ID: <2342@west.West.Sun.COM>  
Date: 23 Oct 91 17:42:31 GMT  
Sender: news@west.West.Sun.COM  
Organization: Sun Microsystems, Phoenix, AZ  
Lines: 28

Hot off the presses...

To enable FM transmit from 136-174, 410-470, do the following:

1. Remove the front panel.
2. Don't cut the green wire. If it is cut, splice it back.
3. Disconnect front panel unit cable.
4. Remove two screws in front panel back and remove rear cover.
5. Locate row of resistors next to Lithium Battery.
6. Remove R54 and R55 - clearly marked, the two nearest the battery.
7. Reassemble. No MPU reset necessary.

Note: Removing only R54 enables MARS/CAP only. Removing both enables all.

-fred

--

| Fred Lloyd AA7BQ Fred.Lloyd@West.sun.com |  
| Sun Microsystems, Inc. ...sun!flloyd |  
| Phoenix, AZ (Reality -- what a concept!) (602) 275-4242 |

From: tonyb@ka.NOvell.COM (Tony Bamberger)  
Newsgroups: rec.radio.amateur.misc  
#Subject: Re: TM-741A MODS...  
Message-ID: <9110232254.AA10244@ka.novell.com>  
Date: 23 Oct 91 22:54:37 GMT  
Sender: daemon@ucsd.Edu  
Organization: UCSD Usenet Gateway  
Lines: 50

I HAVE THE FOLLOWING CORRECTIONS TO FRED'S MODS FOR THE NEW KENWOOD TM-741A MULTI BAND RADIO...

> Hot off the presses...  
>  
> to enable FM transmit from 136-174, 410-470, do the following:  
>

- > 1. Remove the front panel.
- > 2. Don't cut the green wire. If it is cut, splice it back.
- > 3. Disconnect front panel unit cable.
- > 4. Remove two screws in front panel back and remove rear cover.
- > 5. Locate row of resistors next to Lithium Battery.
- > 6. Remove R54 and R55 - clearly marked, the two nearest the battery.
- > 7. Reassemble. No MPU reset necessary.
- >
- > Note: Removing only R54 enables MARS/CAP only. Removing both
- > enables all.

THIS IS NOT 100% CORRECT. ACCORDING TO THE MOD SHEETS I HAVE FROM KENWOOD, YOU HAVE TO CUT THE GREEN WIRE AND REMOVE R54 FOR MARS/CAP MOD.

FOR THE DC-LIGHT MOD, YOU RESPLICE THE GREEN WIRE (IF CUT) AND REMOVE BOTH R54 AND R55.

ONE SIDE NOTE, NO RESET IS NEEDED AS MENTIONED ABOVE, BUT IT DOES WIPE OUT THE VALUES STORED IN THE VFO MEMORIES (AT LEAST ON THE RADIO'S MOD'ED AROUND HERE).

AS LONG AS WE'RE TALKING MODS...

FOR EXTENDED RECEIVE ONLY OTHER THAN THE 144 & 440 (WHICH ARE ALREADY EXTENDED)  
 YOU ONLY CUT THE GREEN WIRE. THIS GIVES YOU 10 METER COVERAGE FROM 18-54 MHZ, 6 METER COVERAGE FROM 40-90 MHZ, 220 COVERAGE FROM 215-260 MHZ AND 1.2 GHZ COVERAGE FROM 1100-1400 MHZ. NOTE THAT THESE ONLY APPLY IF THE SPECIFIC MODULE IS INSTALLED IN THE RADIO (I.E. 10 METER, 6 METER, 220 OR 1.2 GHZ)...

```
> -fred
> --
> | Fred Lloyd AA7BQ                      Fred.Lloyd@West.sun.com |
> | Sun Microsystems, Inc.                  ...sun!flloyd |
> | Phoenix, AZ (Reality -- what a concept!) (602) 275-4242 |
```

Tony Bamberger, N6TYG

```
+-----+-----+
| Tony Bamberger      | UUCP:      [ames,sun,apple,leadsv]!excelan!tonyb |
| Novell Inc.         | Internet:  tonyb@novell.com                       |
| Engineering Dept.   | Packet:    N6TYG @ N6LDL.#NOCAL.CA.USA.NA         |
| 2180 Fortune Drive  | TCP/IP:    [44.4.2.24] tony@n6tyg.ampr.org         |
| San Jose, CA. 95131 | Voice:     (408) 473-8469 FAX: (408) 433-9827     |
+-----+-----+
```

From: Robert.Buaas@Eng.SUn.COM (Robert Buaas [CONTRACTOR])  
 Newsgroups: rec.radio.amateur.misc  
 #Subject: Having trouble with your new Kenwood TM-741A?  
 Message-ID: <9111060321.AA05966@rats.Eng.Sun.COM>  
 Date: 6 Nov 91 03:21:58 GMT  
 Sender: daemon@ucsd.Edu  
 Organization: UCSD Usenet Gateway  
 Lines: 35



Are you hearing "birdies" in the 440 MHz position on your new Kenwood TM-741A? I've had the problem with mine, and have been talking with other people who are having the same problem. Kenwood couldn't duplicate the problem and returned my 440 deck. The problem appears either as weak wandering carriers, or intermods with other input signals. Seldom is the signal strength greater than S2, but the squelch stays open most of the time. K6DYD has traced the problem to instability in the RF front-end (Q1, Q2), which is electronically switch out of the signal path by IC8 when out-of-band frequencies are selected. The solution appears to be placing a 220-ohm 1/4-watt resistor from pin-10 of IC8 to ground--this damping in what appears to be a signal leakage path prevents the instability or parasitic oscillations causing the problem. He further observed that, if the control head is modified for full-frequency operation by removing the jumpers labeled R54 and R55, the RF preamp is continuously removed from the signal path unless the GREEN WIRE on the processor motherboard has been cut. During proper operation, pin-9 of IC8 should change state when tuning in-band vs. out-of-band.

The 220 MHz deck seems to enjoy having its VCO modulated by AC coming in the power cord. Alternator whine is annoyingly present during both transmission and reception. No cure identified yet.

For those of you that want 220-440-1200, simply remove the 144 module, move the power cable into another module, restuff the frame, restart while resetting the VFO limits... Works fine.

I would appreciate hearing from any of you having similiar problems; writing to customer relations is also a good idea. If you're considering one of these units but don't want the 2M deck, also write Kenwood. I've lost count of people who said they wanted this option. I'd like to be able to get all the decks separately from the bare frame.

All in all, it's a nice radio--it just has growing pains; the sooner Kenwood owns up to the problems and fixes them, the more they'll sell.

-Bob Buaas K6KGS (Internet: buaas@nosc.mil) (Phone: 714/968-0070)

From: flloyd@L1-A.West.Sun.COM (Fred Lloyd SUN Phoenix SE 602-275-5537 x17)  
Newsgroups: rec.radio.amateur.misc  
#Subject: TM-741 Mods - More Surprises  
Summary: 200 memory Channels per band  
Message-ID: <2414@west.West.Sun.COM>  
Date: 8 Nov 91 16:13:13 GMT  
Sender: news@west.West.Sun.COM  
Organization: Sun Microsystems, Phoenix, AZ  
Lines: 47

Since my last posting on the TM-741, I've discovered yet another fact about the rig - yes, the unit has 200 memory channels PER BAND!

I found these quite by accident. As some of you may recall, I had been having UHF receive problems on my all-band xmit mod'ed 741, which were suddenly cured when the magic 'green wire' was cut.

Last night, quite by accident, I hit an 'improper' key sequence,

(F)-(REV) in combination and suddenly my display looked a little funny. Instead of the normal memory channel number, the display showed A1 as the channel number. Upon further investigation, it appears that there are 100 additional memory channels under the (F)-(REV) key combination. The keyboard command chart which came with the rig indicates that the (F)-(REV) combination is unused.

The extra 100 memory channels are arranged as follows:

A1,A2,...A9,B0,B1,B2..C0..D0..E0..F0..G0..H0..I0..J0..J8,J9,AA

(A1 is channel 101 and AA is channel 200)

To toggle between the 100 channel banks, one need only press (F)-(REV) as desired. Works in VFO and in Memory mode.

Both bands have additional memory channels as described above.

For reference, my radio is configured in the following fashion:

1. Resistors R54 and R55 removed from the control head.
2. Cross-band Repeat mod (resistor removed) on base unit.
3. Green wire cut on base unit.

I hope others will find this helpful.

-fred AA7BQ

--

```
| Fred Lloyd AA7BQ                               Fred.Lloyd@West.sun.com |
| Sun Microsystems Computer Corporation           ...sun!flloyd |
| Phoenix, AZ (If it's a fact, I believe it!)    (602) 275-4242 |
```

From: wa2ise@cbnewsb.cb.att.com (robert.f.casey)

Newsgroups: rec.radio.amateur.misc

#Subject: TM741 notes and mods 5/10

Keywords: mods

Message-ID: <1991Nov9.205522.18746@cbfsb.att.com>

Date: 9 Nov 91 20:55:22 GMT

Sender: news@cbfsb.att.com

Organization: AT&T Bell Laboratories

Lines: 261

copied from packet:

```
Msg# TSF Size #Rd Date Time From MsgID To
63978 BH 3517 1 20-Oct 1035 IS0XSE 3001_IW0UHD KENWOO@WW (NONE)
Sb: Replay xse bulletin #1
```

TM-741A/E FREQUENCY EXTENSION

Phase 1

- a) Side the release knob on the front panel to the right and remove the panel (be careful with the cable between the panel and the main unit.)
- b) Cut the green wire located in the left side (tape the bare ends of the wire to prevent shorts.)
- c) Switch the power on (a melody sounds to confirm the change.)

Phase 2

- a) Unplug the connectors of the cable between the panel and the main unit.
- b) Remove the two screws on the rear of the panel and open the rear of the case.
- c) On the left side of the lithium battery there are four jumpers marked R54, R55, R56 and R57 corresponding respectively to b0, b1, b2 and b3 bits described below. Set the four bits as required for your country:
  - European Countries:  
mode \$05  
b3 = 0  
b2 = 1  
b1 = 0  
b0 = 1
  - USA, Canada and Asia:  
mode \$03  
b3 = 0  
b2 = 0  
b1 = 1  
b0 = 1
- d) Refit the rear of the case by reversing the order of disassembly.

Frequency range after modification (\*)

| unit | rx range |      | tx range |      | SHIFT       |              |      |
|------|----------|------|----------|------|-------------|--------------|------|
|      | min      | max  | min      | max  | EUROPE      | USA CAN      | ASIA |
| 28   | 18       | 54   | 26       | 45   | +/- 100 KHz | idem         |      |
| 50   | 40       | 90   | 46       | 76   | +/- 1 MHz   | idem         |      |
| 144  | 118      | 174  | 136      | 174  | +/- 600 KHz | idem         |      |
| 220  | 215      | 260  | 215      | 235  | +/- 1.6 MHz | idem         |      |
| 430  | 410      | 470  | 410      | 470  | +/-1.6,-7.6 | +/- 5 MHz    |      |
| 1200 | 1100     | 1400 | 1100     | 1400 | +35, -6 MHz | +/-12,-20MHz |      |

(\*) For 900 MHz rx-only band see bulletin #3.

Be happy and 73 de Antonello is0xse,  
Cagliari, Sardegna, Italia, Europa... MONDO!!!!!!

IS0XSE @ IW0UHD.ITA.EU

xse bulletin #2: KENWOOD MODIFICATIONS [#2 of 10]

TM-741A/E AM RECEPTION WITH 28 AND 50 MHZ UNIT  
=====

- a) Press the [F] key, then press [BELL] key within ten seconds. An A is displayed at the hundred-MHz position to indicate AM mode.
- b) To return to FM mode press the [F] again, then press the [BELL] within ten seconds.

That's all, folks!

Be happy and 73 de Antonello is0xse,  
Cagliari, Sardegna, Italia, Europa... MONDO!!!!!!

xse bulletin #3: KENWOOD MODIFICATIONS [#3 of 10]

TM-741A/E 900 MHz BAND RECEPTION WITH 430 MHZ UNIT  
=====

Band change  
-----

To change to the 900-MHz band, select the 430-MHz band, then press and hold down the [MHZ] key for at least a second. Now 850.000 (initial setting) is displayed.

To return to the 430-MHz band, press the [MHZ] key again for at least a second.

Adding a secondary 900-MHz dedicated antenna in the 430-MHz unit  
-----

- a) Remove the power supply cable from the power supply or battery.
- b) Remove the 430-MHz band unit with care.  
For removal procedure see the INSTRUCTION MANUAL - UNIT INSTALLATION, reversing the order of the procedure and... using the brain!
- c) Remove the shield plate (12 screws.)
- d) Solder a coaxial cable (0.8 D) to the input side of IC9 (center is aligned with the IC9, ground at right side.)
- e) Pass the cable through the notch and install the shield plate.

f) Reassemble the main unit.

xse bulletin #4: KENWOOD MODIFICATIONS [#4 of 10]

TM-741A/E MEMORY CHANNEL DOUBLING  
=====

Each band can be switched to the normal memory (100 channels) and rear memory (100 channels). Each band can contain 200 channels and... yes, a total of 600 channels can be used for three bands!

SORRY! This function can be enabled only by extending the receive frequency (see bulletin #1 of this

To switch the memory, hold down the [F] key and press the [REV] key:  
Normal Memory (100 ch) <--> Rear Memory (100 ch)

The functions of the rear memory are the same as the normal memory, but memory channels are displayed as follows (rather than 01 to 00):

|                    |                    |
|--------------------|--------------------|
| A1 - b0 == 01 - 10 | b1 - c0 == 11 - 20 |
| c1 - d0 == 21 - 30 | d1 - E0 == 31 - 40 |
| E1 - F0 == 41 - 50 | F1 - G0 == 51 - 60 |
| G1 - h0 == 61 - 70 | h1 - i0 == 71 - 80 |
| i1 - J0 == 81 - 90 | J1 - AA == 91 -100 |

xse bulletin #5: KENWOOD MODIFICATIONS [#5 of 10]

TM-741A/E REPEATER MODIFICATION (TRANSPONDER FUNCTIONS)  
=====

WARNING: Extended continuous transmission may cause a failure of the equipment. See "transmission time limit" below.

Preliminary hardware modification  
-----

- a) Loosen the four screws on the side of the set.  
Remove the four screws on the bottom of the set.  
Remove the bottom of the case.
- b) Locate the two jumpers on the Control Unit, on the opposite side of the panel (see in figure, below.)

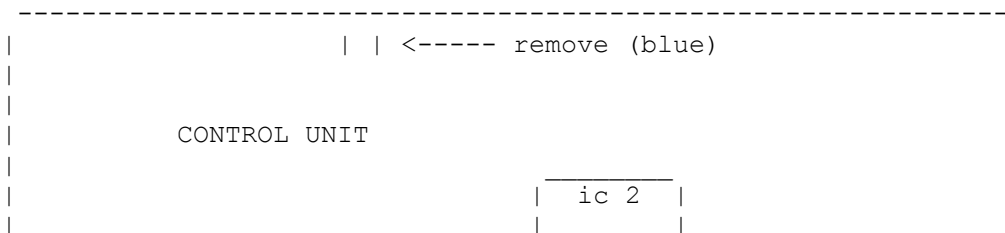

-----  
panel side

- c) Remove the blue chip jumper (0 OHM). Use a soldering iron with a thin tip in order not to damage other components or patterns.
- d) Refit the rear of the case by reversing the order of disassembly.

#### Fixed-band repeater operation

-----

With the fixed-band repeater, the transmission band is fixed, and if a signal come in on the remaining band, and the BUSY turns on, the transmit mode is entered and modulation is done using the received signal.

- a) If the option band is present, turn off one of the three band.
- b) Set the frequencies of two bands (rx/tx split are also permitted.)
- c) Set a band as the transmission (PTT display) and operation (green indicator) band (press the band select key.)
- d) Hold down the [F] key for at least a second (the red led flashes), then press the [MUTE] key.

#### Cross-band repeater operation

-----

When the cross-band repeater function is being used, a signal enters one of two bands. Busy turns on, the other band enters the transmit mode and modulation is done with the received signal.

- a) Set the frequencies of two bands (rx/tx repeater split are also allowed.)
- b) Set a band as the transmit band (PTT display) and the other as the operation band (green indicator). This arrangement can be reversed.
- c) Hold down the [F] key for at least a second (the red led flashes), then press the [MUTE] key.  
The dots on both frequency display flash, and the cross-band repeater works. Only reception is possible in the remaining band.

#### Dual-in repeater operation (when the option band is installed)

-----

With the dual-in repeater, the transmit band is fixed, and if a signal comes in on one of the other bands, Busy turns on, transmit mode is entered and modulation is done using the received signal.

- a) Set the frequencies of all three bands.
- b) Set a band as the transmission (PTT display) and operation (green indicator) band (press the band select key.)
- c) Hold down the [F] key for at least a second (the red led

flashes), then press the [MUTE] key.  
The dots on the frequency display light.

#### Turn-off repeater

-----  
To turn the repeater off, hold down the [F] key for at least a second (the red led flashes), then press the [MUTE] key. The state before setting returns.

#### Repeater transmission time limit setting

-----  
The repeater transmission time limit is set with the time-out timer (TOT). The time can be set to 3, 5, 10, 20, 30 minutes, or OFF. (See the item about the TOT of the main unit.)

Be happy and 73 de Antonello is0xse,  
Cagliari, Sardegna, Italia, Europa... MONDO!!!!!!

ISOXSE @ IW0UHD.ITA.EU

5 of 10 more to come if and when I see 'em on packet!

=====  
Note: I haven't tried or verified this, proceed at your own risk, and do not transmit outside of legal bands. WA2ISE





From: flloyd@L1-A.West.Sun.COM (Fred Lloyd [Phoenix SE])  
Newsgroups: rec.radio.amateur.misc  
Subject: Undocumented Kenwood Features/Games TM-741/TM-732  
Date: 27 Apr 1992 16:19:05 GMT  
Organization: Sun Microsystems, Phoenix, AZ  
Lines: 114  
Message-ID: <kvoabpINN1n6@west.west.sun.com>  
NNTP-Posting-Host: 11-a.west.sun.com

FUN AND GAMES WITH KENWOODS LATEST DUAL BANDERS

UNDOCUMENTED FEATURES ON THE TM-741A and TM-732A

by Fred Lloyd, AA7BQ

Over the weekend, I took some time to experiment with my Kenwood mobile rigs and was quite surprised at what I found.

TM-741A

The 741 has three undocumented games built into it which are somewhat amusing. There is a "slot machine", a "space invaders" and a "musical keyboard".

To activate, press and hold the F and MUTE keys while turning on the power. The display will come up showing -1- -2- -3-  
To activate game 1, press the Band 1 (leftmost) control, for game 2, press the Band 2 (middle) control, and for game 3, the Band 3 (rightmost) control.

Game 1 - "Slot Machine"

To start the wheels rolling, hit the MUTE key. The display shows "0 0 0" Then, press the Band 1, Band 2, and Band 3 keys in order to stop each of the wheels in turn. The radio emits a "phaser" sound when the wheels stop. I haven't hit the jackpot yet, so I don't know how it acts when the three numbers match... Use the VFO key to cancel the game and return the radio to normal operation.

Game 2 - "Space Invaders"

Activate game 2 as shown above. The leftmost display will clear to all zeros. The center display is the "target". The rightmost display is some sort of shot counter. Manipulate the lower button row to play the game. The rig plays a tune when the game is over. Scores advance (with the phaser sound) as the game progresses. I don't know much more about it and don't exactly know the object of the game but I'm sure that someone will figure it out. Again, the VFO key cancels the game mode.

Game 3 - "Musical Keyboard"

Activate game 3 as shown above. The display says "Enjoy Sound Play". Each of the keyboard controls now plays a distinct tone. The VFO key

cancels the mode. There are apparently 15 different tones available.

-----

It's also worth mentioning that the radio receivers continue to operate while game playing takes place. Presumably, one could idle away the time playing games while sitting by the radio and listening for important calls...

#### OTHER TM-741 UNDOCUMENTED FEATURES

##### DISPLAY TEST

Hold down F and MHZ while turning on power. This activates the display test mode where all segments and indicators are lit. Note the "ACC" indicator at the lower right. ACC is not defined in the manual, however I saw it come on once one night after I started the car with the radio turned on. The display lit up ACC and the UHF frequency display showed some sort of HEX code (a ROM checksum maybe?).

##### STRANGE TEST

(WARNING: YOU MAY LOSE SOME SAVED MEMORY DATA)

Hold down the F and MR keys while turning on power. The radio plays a wild sequence of tones and the displays go all crazy for several seconds. When it's done, everything seems normal except that the memory contents are reshuffled and some memories are duplicated. I can only speculate that this might be some sort of factory memory test...

-----

#### UNDOCUMENTED TM-732A FEATURES

##### CLONE MODE

Hold down the F and MHZ keys while turning on power. The current control band will display CLonE. Pressing CALL initiates the data transfer, graphically illustrated by a moving S-METER display. No RF is transmitted during data transfer, instead it is assumed that the data is dumped out of the microphone port. Nothing more is known about this at this time.

##### AM DETECTOR CONTROL

The AM Detctor, which automatically comes on below 136 MHz, can be forced ON at any VHF frequency by pressing the F and MUTE keys while applying power. Radio continues to transmit FM but receives AM. Changing frequencies or memory channels will cancel the forced AM mode. This capability could be useful for listening to the USAF Thunderbirds which sometimes operate in the 143 MHz band using AM.

-----

Well, that's it for now. Please let us know if you can discover any of the other undocumented features available on the new rigs.

-fred

--

|                                             |                         |
|---------------------------------------------|-------------------------|
| Fred Lloyd AA7BQ, Systems Engineer          | Fred.Lloyd@west.sun.com |
| Sun Microsystems Computer Corporation       | ...sun!flloyd           |
| Phoenix, AZ (If it's a fact, I believe it!) | (602) 275-4242          |



From: au297@cleveland.Freenet.Edu (Jim Evers)  
Newsgroups: rec.radio.amateur.misc  
Subject: Kenwood TM-741a GAME Dox!!  
Message-ID: <1992May7.014325.13843@usenet.ins.cwru.edu>  
Date: 7 May 92 01:43:25 GMT  
Sender: news@usenet.ins.cwru.edu  
Organization: Case Western Reserve University, Cleveland, Ohio, (USA)  
Lines: 112  
Nntp-Posting-Host: cwns2.ins.cwru.edu

\*\*\* Kenwood TM-741a GAME Dox \*\*\*  
-----

Introduction:

There are actually three GAMES "hidden" on the Kenwood TM-741a Multiband Transceiver. These are UNDOCUMENTED and I'm not exactly sure who originally found these games??.. (I came across a brief description of these hidden games on rec.radio.amateur.misc on UseNet, but no one had the complete original Post!)

How to access "Game Mode":

- 1) Turn OFF the TM-741a.
- 2) Hold the [F] + [MUTE] and turn ON the TM-741a.

(You should see: -1- -2- -3- on your display, you're now in "Game Mode"!!)

3) Select the Game you wish to play by hitting the appropriate Band Select Button. ( -1- = Band Sel 1 <far left>; -2- = Band Sel 2 <middle>; -3- = Band Sel 3 <far right> )

-1- ==> SLOT MACHINE Game  
-2- ==> SPACE INVADERS Game  
-3- ==> MUSICAL KEYBOARD

NOTE! The [VFO] will always exit you to the Main Game Menu (-1- -2- -3-).. The [MUTE] will normally Start the Game.

Game #1: SLOT MACHINE:

To play... Hit [MUTE] to start the numbers tumbling. Starting from the left and proceeding to the right, hit the Band Select Buttons to stop each number! If you don't get a 3-in-a-row match, the radio plays a sound and the game is over. ([MUTE] to play again). If you match 3-in-a-row, then...well I won't spoil it for you!.. (It's neat!!)

Remember; [VFO] to return to the Game Menu.

Game #2: SPACE INVADERS:

The Display... You will see the following display:

000000    -----    0-0

(Score) (Invaders) (Selected Number - Number of Lives Left)

To play... Hit the [LOW] key to begin. The radio will then put a random number from 0 - 9 in the first position in the dashes.. ( 4----- ) you must then use the [TONE] key to select the number the radio selected and then quickly hit the [MUTE] key to "fire" it. The number will then disappear and a new one will appear!.. If you don't act fast, the number will move to the second dash and another random number will appear, ( 84---- ).. If you're not keeping up, eventually the numbers will reach then last dash line and you will lose a life!.. (Once all lives are lost, the game is over!) Also, you must "destroy" 30 numbers before moving onto the next round!.. Each round will start getting faster and faster!.. So be prepared!! (It really gets TOUGH!!) All throughout the game it will keep score of how many "hits" you made.. (I believe it's 10 points a hit, I think!)..

Remember; Hit [VFO] to return to Game Menu.

Game #3: MUSICAL KEYBOARD:

I don't think this is actually a "Game"??.. What I've been able to figure out is that when you select this "game" the following message appears on the display:    Enjoy Sound Play

At this point, the whole keypad on the face-plate of the TM-741a is a "Musical Keyboard"!.. Try it, hit any of the keys, Band Select Buttons; Cont Sel Buttons; [MUTE]; [TONE]; [MHZ]; Etc...etc..etc... (Except for the [VFO] key, that returns you to the Game Menu!)

=====

Welp!.. That about all I know!.. Some other things you could try are:

[F] + [REV] (I think!) and Power ON.. (NOTE!!.. This MAY alter some of your memory!! SO write it all down in case you need to re-enter it!)

...this will play some wierd tune on all of your Bands!! It's actually kinda neat...

And one other.. (Which might be documented..??)

[F] + [MHZ] (I think!) and Power ON..

...this will display a light EVERYTHING on the display!!!!

=====

If anyone has any other "hidden" features, Mods, etc.. PLEASE send them to me at:

usr1118a@tso.uc.edu

I hope this has been useful to all!.. and I appologise not crediting the person who originally found these Games!.. (Have no idea who it was!)

Have fun, and enjoy!!... Take care!.. and 73! ....KB8NHT (..Jim)





From elroy.jpl.nasa.gov!usc!howland.reston.ans.net!darwin.sura.net!rouge!jpd  
Mon May 10 00:00:28 PDT 1993  
Article: 39100 of rec.radio.amateur.misc  
Newsgroups: rec.radio.amateur.misc  
Path: elroy.jpl.nasa.gov!usc!howland.reston.ans.net!darwin.sura.net!rouge!jpd  
From: jpd@ucs.usl.edu (Dugal James P.)  
Subject: Kenwood 741 Out of Band Problem  
Message-ID: <1993May6.221501.11693@usl.edu>  
Sender: anon@usl.edu (Anonymous NNTP Posting)  
Organization: Univ. of Southwestern La., Lafayette  
References: <easu348.736570081@orion.oac.uci.edu>  
<1993May5.093936.49823@kuhub.cc.ukans.edu>  
Date: Thu, 6 May 1993 22:15:01 GMT  
Lines: 12

The concensus of those discussing the TM741A mods some time back, was that if you removed R54 and R55, you should also CUT the green wire. Kenwood had printed some instructions that said to not to cut it, but the result was poor sensitivity, birdies, etc. Perhaps this is related to your problem?

73,

--

-- James Dugal, N5KNX Internet: jpd@usl.edu  
Associate Director Ham packet: n5knx @k5arh (land), UO-22  
(sat.)  
Computing Center US Mail: PO Box 42770 Lafayette, LA  
70504  
University of Southwestern LA. Tel. 318-231-6417 U.S.A.

From elroy.jpl.nasa.gov!usc!howland.reston.ans.net!noc.near.net!uunet!olivea!  
pagesat!spssig.spss.com!feenix.metronet.com!marcbg Mon May 10 00:00:34 PDT  
1993  
Article: 39219 of rec.radio.amateur.misc  
Newsgroups: rec.radio.amateur.misc  
Path: elroy.jpl.nasa.gov!usc!howland.reston.ans.net!noc.near.net!uunet!olivea!  
pagesat!spssig.spss.com!feenix.metronet.com!marcbg  
From: marcbg@feenix.metronet.com (Marc Grant)  
#Subject: Re: Kenwood 741 Out of Band Problem  
References: <easu348.736570081@orion.oac.uci.edu> <C6n6zz.4tt@SSD.intel.com>  
Organization: Tx Metronet Communications Services, Dallas Tx  
Date: Sun, 9 May 1993 04:22:26 GMT  
Message-ID: <C6qs5E.8Cx@feenix.metronet.com>  
Lines: 21

Concerning the 800 Mhz band sensitivity problem, SOMEWHERE, SOMEPLACE, I remember seeing a mod for fixing the sensitivity problem with the 741. At the time, I wasn't interested in doing the mod, so I didn't save it. This is not to be confused with the mod to add an extra antenn for 800 MHz.

My 741 works just fine receiving from 420 to about 470 or so, with apparently very good sensitivity. I have R54 and R55 cut and the green wire cut.

If anyone who is following this thread is aware of the 800 MHZ sensitivity mod (repeat, not the seperate 800 MHZ antenna mod) why not share it with the rest of us?

73

--

|Marc Grant | Internet: marcbg@feenix.metronet.com  
|POB 850472 | Amateur Radio Station N5MEI  
|Richardson, TX 75085| Fax: 214-231-0025 Voice: 214-231-3998

- ..... - - ... - - .- .-... -... ..- -... -... -... ..-



Subject: TM-742/942 Remote Control

Yes, it can be controlled remotely. Here's what Kenwood sent me after I called up and asked. What they don't make clear is that when the unit is in \*microphone\* remote control mode, any tones heard through the mic will also control the radio, including what comes through the speaker! That mode allows you to do more than the limited "official" DTMF remote control--things like adjusting the squelch, for instance. Also, note that once you've given the access code, there is no access control other than PL tones, until you turn off remote control by sending A#. This also means that you need to be very careful with the mic when it's controlling the radio, because I've found that it's very liberal about what it interprets as a DTMF tone, including such things as white noise, road noise, and the clunks and bangs of hanging up the mic.

The remote mode described below is essentially identical to that for the 732A.

A setup that I've found works very nicely is to run crossband repeat between 220 and 2 meter, and control through 440 simplex. Lets me use my HT on 220, with no control signals on the talk channel. Cool!

73,

-Randy, KD6ULI

-----  
TM-942A, TM-742A

REMOTE CONTROL BY EXTERNAL DTMF SIGNAL, Instruction Manual Addendum

This transceiver can be remote-controlled by any other transceiver which can transmit DTMF tones. This instruction is similar to Remote Control by DTMF Microphone, page 61

#### FUNCTION SELECTION

1. Select a common band for the TM-742A/942A and the remote control transceiver, and enter the same frequency on both transceivers. Enter a 3 digit DTSS code (xxx) on the TM-742A/942A (Refer to Note 2.) The DTSS icon must be displayed. (See DTSS code selection, pages 72 through 75.)
2. Press the Band Sel key (push the volume control) to select the band to be controlled. DTSS should be turned off on this band.

Repeater Mode: If you intend to operate the transceiver in the Repeater mode, review Instruction Manual pages 59 & 60, Operation as a Repeater, for an explanation of Fixed Band and Cross Band Repeater modes. This is not a 100% duty cycle transmitter. Before selecting the Remote Control mode, set the transmitter output power to Low or Medium, and set the Time-Out-Timer (page 32) at three (3) minutes.

3. Press the RC key on the transceiver. The RC and DTSS icons will flash.

#### OPERATION

1. Be sure the frequency for the remote transceiver is the same as the TM-742A/942A, and that the remote transceiver's DTSS (if so equipped) is off.
2. Control mode initialize. Place the remote transceiver in transmit, and send "A" (fourth column key, not alphabet) followed by the correct 3 digit DTSS code (xxx), then "#". Each key press and space must be less than 1 second each. Using DTMF memory will be the most convenient method to send this control string. (Two or three attempts may be required.)
3. On the transceiver under remote control, the DTSS icon will display steadily, and the RC icon will continue to flash. The transceiver is now ready to accept external DTMF Remote Control.

#### FUNCTIONS WHICH CAN BE CONTROLLED BY THE REMOTE TRANSCEIVER

| Function                                                | DTMF keys (Notes) |
|---------------------------------------------------------|-------------------|
| CALL CH. mode ON                                        | 7                 |
| CALL CH. mode OFF<br>(Return to VFO mode)               | 8                 |
| Control mode initialize                                 | A, xxx, #         |
| Control mode exit                                       | A, #              |
| CTCSS ON                                                | 3                 |
| CTCSS OFF                                               | 6                 |
| Frequency entry<br>(In VFO mode. Use numeric keys)      | A, 0-9            |
| MR mode ON                                              | 9                 |
| MR mode ch no. select<br>(In MR mode. Use numeric keys) | A, xx             |
| MR mode OFF<br>(Return to VFO mode)                     | 8                 |
| T.ALT ON                                                | 1                 |
| T.ALT OFF                                               | 4                 |
| Tone Freq. Sel<br>(xx=2 digit tone ch. no 0138)         | B, A, xx          |
| Tone ON                                                 | 2                 |
| Tone OFF                                                | 5                 |
| TX power (H=no letter, M, L)                            | 0                 |
| UP (freq, tone or MCH)                                  | #                 |
| Down (freq, tone or MCH)                                | *                 |
| VFO mode                                                | 8                 |
| X-Band Repeat ON<br>(& then exit Control mode)          | C, A, #           |
| X-Band Repeat OFF<br>(Restart Control mode initialize)  | A, xxx, #, D      |

## Notes

1. To set the memory channels or tone frequency channels, select the mode, then input the channel number using the numeric keys. For the tone freq. channel numbers, please see page 70. (The UP or DOWN buttons may also be used to increment or decrement channels or VFO frequency, but no acknowledge or feedback is provided.)
2. It is presently not legal to transmit control codes below 222MHz. Since it is illegal to transmit control tones (DTMF) on the 2m band, you must enter a 3 digit DTSS code (xxx) on the 440MHz band. The DTSS icon must be displayed on the 440MHz band.
3. The microphone, and the mic element, are always on, including in the RC mode. DTMF tones from the transceiver's speaker, or from a telephone with speaker, may "take control" of the radio, just as pressing a DTMF button on the microphone. It is not advisable to leave the radio unattended in the RC mode.
4. There is one function which is not supported and cannot be recovered by the remote transceiver: RC cancel, go to the Intercom mode. Press A, B. This is one-way & must be reset with transceiver RC button!

--

Internet: gobbel@ucsd.edu

-----  
Hi! I am a .signature virus. Copy me into your .signature to join in!



From: wa2ise@cbnewsb.cb.att.com (robert.f.casey)  
Newsgroups: rec.radio.amateur.misc  
Subject: TM941a mod  
Keywords: mods  
Message-ID: <1991Sep4.022615.5278@cbfsb.att.com>  
Date: 4 Sep 91 02:26:15 GMT  
Sender: news@cbfsb.att.com  
Organization: AT&T Bell Laboratories  
Lines: 11

copied from packet:

| Msg#            | TSF | Size | #Rd | Date   | Time | From  | MsgID       | To             |
|-----------------|-----|------|-----|--------|------|-------|-------------|----------------|
| 61040           | BF  | 768  | 1   | 31-Aug | 2348 | N2JJA | 42155_N2IMC | MODS@ALLBBS () |
| Sb: TM 941A MOD |     |      |     |        |      |       |             |                |

There is one quick MOD when removing the detachable front display: by cutting the green wire it will give you TX on MARS only. It RX's out of band but not that far before it dies on RX.

---

Note: I haven't tried or verified this, proceed at your own risk. WA2ISE

Newsgroups: rec.ham-radio  
From: am001@cleveland.Freenet.Edu (Robert S. Radvanovsky)  
#Subject: Kenwood TM-941A UNDOCUMENTED FEATURE  
Message-ID: <1991Oct25.230758.28294@usenet.ins.cwru.edu>  
Sender: news@usenet.ins.cwru.edu  
Nntp-Posting-Host: cwns16.ins.cwru.edu  
Organization: Case Western Reserve University, Cleveland, Ohio, (USA)  
Date: Fri, 25 Oct 91 23:07:58 GMT  
Lines: 53

Documentation follows....

This modification is not really a modification, but an undocumented feature that Kenwood Corporation has no record of. This modification has not been completely tested, so those who feel brave enough to try this out are welcome to it, but I am not responsible for any ill-effects as a result of utilizing this feature.

What this feature offers to the end-user is an extremely powerful feature: doubling your memory capacity. With the Kenwood TM-941A, the radio has ONE VFO, ONE CALL, and 100 memory positions that are labelled 00 thru 99. This feature offers the user another 100 memory positions PER BAND!!!

How to perform this undocumented feature:

1. Have the radio turned on.
2. Press F and REV simultaneously.
3. Memory position A1 will show; this memory position cannot be eliminated thru the MR/F function.
4. Work the VFO in a similar manner that you would with the



- radio in normal mode.
5. When you save the memory position, take a look around at the layout of these memory positions -- the memories are labelled hexidecimally; that is, they are labelled AA thru A9, B0 thru B9 until you have reached J9. J9 is the 100th position in this alter memory area.
  6. When you are finished, just press the F and the REV buttons simultaneously, and you are back in the normal memory area.

As stated before, this feature has been found to be static in nature; that is, when the power is turned off, the memory positions are still retained and do not interfere with the original memory area. Mind you, this memory feature has not been completely tested, SO BE EXTRMELY CAREFUL! I ASSUME NO LIABILITY FOR FINDING THIS FEATURE SINCE I AM DOING THIS AS A BENEFIT TO AMATEUR RADIO!

BTW, Kenwood does not have any records and/or any comments regarding this feature. I suspect that this feature is for diagnostic purposes and should be treated as such. Forewarned is forearmed!

Enjoy and 73! :-)

--

Robert S. Radvanovsky           InterNet: am001@cleveland.freenet.edu  
kempyuter kensulting            AMPRNet: kc6onl@kc6onl.ampr.org  
4 Haverhill Road                AX.25Net: kc6onl@kc6nzn.#soca.ca.us  
Laguna Niguel, CA 92677

From: am001@cleveland.Freenet.Edu (Robert S. Radvanovsky)  
Newsgroups: rec.radio.amateur.misc  
#Subject: Kenwood TM-941A Addendum  
Message-ID: <1991Nov2.041724.25046@usenet.ins.cwru.edu>  
Date: 2 Nov 91 04:17:24 GMT  
Sender: news@usenet.ins.cwru.edu  
Organization: Case Western Reserve University, Cleveland, Ohio, (USA)  
Lines: 19  
Nntp-Posting-Host: cwns10.ins.cwru.edu

Referring to the UNDOCUMENTED feature regarding 100 EXTRA MEMORY positions -- this will only work if you have installed either (if not both -- why not both?) modifications to the tribander radio. These features are: EXTENDED RECEIVE and CROSS-BAND REPEAT. Please install these modifications BEFORE trying to utilize those extra 100 memory positions.

For those that are interested in these modifications, please send me your HOME (current) mailing address via E-mail to this account... 73! ;-)

BTW -- this feature has been verified by THREE hams now...

--

Robert S. Radvanovsky           InterNet: am001@cleveland.freenet.edu  
kempyuter kensulting            AMPRNet: kc6onl@kc6onl.ampr.org

4 Haverhill Road  
Laguna Niguel, CA 92677

AX.25Net: kc6onl@kc6nzn.#soca.ca.us



Path: njitgw.njit.edu!dorm.rutgers.edu!rutgers!cs.utexas.edu!usc!samsung!  
sol.ctr.columbia.edu!spool.mu.edu!agate!usenet.ins.cwru.edu!  
cleveland.Freenet.Edu!am001  
From: am001@cleveland.Freenet.Edu (Robert S. Radvanovsky)  
Newsgroups: rec.radio.amateur.misc  
Subject: Kenwood TM-941A UNDOCUMENTED FEATURE  
Message-ID: <1991Oct25.230758.28294@usenet.ins.cwru.edu>  
Date: 25 Oct 91 23:07:58 GMT  
Sender: news@usenet.ins.cwru.edu  
Organization: Case Western Reserve University, Cleveland, Ohio, (USA)  
Lines: 53  
Nntp-Posting-Host: cwns16.ins.cwru.edu

Documentation follows....

This modification is not really a modification, but an undocumented feature that Kenwood Corporation has no record of. This modification has not been completely tested, so those who feel brave enough to try this out are welcome to it, but I am not responsible for any ill-effects as a result of utilizing this feature.

What this feature offers to the end-user is an extremely powerful feature: doubling your memory capacity. With the Kenwood TM-941A, the radio has ONE VFO, ONE CALL, and 100 memory positions that are labelled 00 thru 99. This feature offers the user another 100 memory positions PER BAND!!!

How to perform this undocumented feature:

1. Have the radio turned on.
2. Press F and REV simultaneously.
3. Memory position A1 will show; this memory position cannot be eliminated thru the MR/F function.
4. Work the VFO in a similar manner that you would with the radio in normal mode.
5. When you save the memory position, take a look around at the layout of these memory positions -- the memories are labelled hexidecimally; that is, they are labelled AA thru A9, B0 thru B9 until you have reached J9. J9 is the 100th position in this alter memory area.
6. When you are finished, just press the F and the REV buttons simultaneously, and you are back in the normal memory area.

As stated before, this feature has been found to be static in nature; that is, when the power is turned off, the memory positions are still retained and do not interfere with the original memory area. Mind you, this memory feature has not been completely tested, SO BE EXTRMELY CAREFUL! I ASSUME NO LIABILITY FOR FINDING THIS FEATURE SINCE I AM DOING THIS AS A BENEFIT TO AMATEUR RADIO!

BTW, Kenwood does not have any records and/or any comments regarding this feature. I suspect that this feature is for diagnostic purposes and should be treated as such.

Forewarned is forearmed!

Enjoy and 73! :-)

--

Robert S. Radvanovsky  
kempyuter kensulting  
4 Haverhill Road  
Laguna Niguel, CA 92677

InterNet: am001@cleveland.freenet.edu  
AMPRNet: kc6onl@kc6onl.ampr.org  
AX.25Net: kc6onl@kc6nzn.#soca.ca.us



Newsgroups: rec.radio.amateur.misc  
From: wa2ise@cbnewsb.cb.att.com (robert.f.casey)  
Subject: TM621 721 731 9600 baud mod file  
Message-ID: <1992Nov27.222610.12678@cbfsb.cb.att.com>  
Keywords: mods  
Sender: news@cbfsb.cb.att.com  
Organization: AT&T  
Date: Fri, 27 Nov 1992 22:26:10 GMT  
Lines: 44

copied from packet:

```
Msg# TSF   Size #Rd  Date  Time  Arrived Seq #      Msg ID      Route
1561 BF    2112   0 23-Nov 0619z 25-Nov (023883 - 13585_KB2LPW) []
KB2LPW ==> MODS@USBBS
"9600 Bd MODS for TM721/731 R here"
```

The mods to do 9600 baud packet using a K9NG or G3RUH modem are fairly simple to do with the Kenwood TM-721/621 radios. Look at your schematic.

Receive data is taken from the discriminator output. Look for the 3.3K resistor coming off pin 9 of the last IF stage. Connect a 1K series resistor from the modem RX input to the junction of the .001 and 3.3K.

PTT is taken off pin 2 on the microphone connector. TX data is fed through a 1K series resistor to the top of VR3 (the deviation control).

This method has been tested and works quite well on 440 MHz and 220 MHz. The mods haven't fully been tested on the 2 meter portion of the radio.

The TM-731 radio is different enough to cause problems. What needs to be done is to add another RX Mute transistor. (Look at the schematic and see how the TX deviation is shorted to ground during receive.) Use a plain NPN and a pair of 10K resistors (copy the one used on VR3 in the schematic). Take the TX data and feed it to the collector through a series 1K resistor, and then feed that through another 1K resistor to the wiper of the deviation pot. This was a result of Kenwood changing the deviation pot value from 10K to 100K. (It wasn't broken, but they fixed it anyway.)

As with any modifications, take reasonable care, and I won't be responsible if you trash your radio. BE CAREFUL; it is full of surface mount

devices.

-----  
=-

This MOD file was written by Jeff, WA6FWI @ WB6YMH.#SOCA.CA.USA.NA  
Schematics and layouts are available by request through the author.

Good Luck!

73 de Chris KB2LPW @ KB2LPW.#NYC.NY.USA.NA  
SYSOP of PDSNET ARC and the Helping BBS's

=====

Note: I haven't tried or verified this, proceed at your own risk. WA2ISE





Subject: RELIABILITY MOD FOR TAPR-2's

Thought we'd share a mod for the tapr-2's. (pk-80, mfj-1270, pac-com, etc.) We noted -5v problems, when using the 5 wire control mode of operation. (not noted when using x-modem programs) this mod not only improves the reliability of operation but also protects the I.C.'s using the -5 volts from being exposed to +5 volts do to a failure of the -5 volt regulator. The indication of failure is the dcd light flickers or stays on even when the radio is turned off.

- 1) Replace the 6.3 volt 1/4 watt zener whit a 6.3 volt 1 watt zener. (CR-6)
- 2) Install a 1N4001-1N4006 diode in paralell with C-10.  
(it may be installed on the bottom of the board the end of the diode without the bar is connected to the (-) side of the cap.)

The modification seems to have worked very well on the 4 tnc's that we have installed it. It won't protect the tnc from all forms of damage but it should minimize problems in the -5 volt area. good luck.

bob, nk8t (member, fara packet users group)

=====

From: NK8T@NK8T

Some MFJ-1270B TNC's may have the calibration and tx audio gain controls, (R-76 thru R-79) mounted incorrectly. As a result these P.C.B. mounted controls will have to be adjusted in reverse direction for proper operation. C.C.W. becomes C.W. and C.W. becomes C.C.W. The problem was first noted on unit S/N 01010124. The adjustment screws should be on the side of the control nearest the power off/on switch. If they aren't simply reverse the adjustment procedures with respect as to C.C.W. and C.W.

BOB, NK8T

=====



Subject: Cleaning up MFJ 1270B

I have recently taken the opportunity to observe electromagnetic compatibility of the MFJ-1270B as used by several of our NET/ROM nodes. (some of this may apply to other brands also.) The initial results were not as good as they should have been. The question was 'Do the TNC's cause interference to co-located sensitive VHF receivers ?' The answer is YES, depending on the situation.

In two different sites measured, the noise coming from the TNC was sufficient to cause 4-7 db worth of desense to a 0.2 uv (12 db SINAD) receiver (145.01). There are two types of noise that are that radiate from the MFJ-1270B. One type is broadband in nature (probably due to data/address bus activity and DC-DC converter operation) the other kind is harmonics from the crystal oscillator and sub-multiples thereof ( $(4.9152/2) * 59 = 144.998$  MHz). The broadband noise can cause interference on all frequencies if a sufficiently sensitive receiver in a quiet location is involved. The harmonic energy can cause problem on specific frequencies.

This interference is detrimental to the weak signals that several of our nodes are required to operate with. In addition it may cause problem to the communications of our hosts when we share a commercial site.

It is relatively easy to determine if you have a harmonic problem because the receiver noise will quiet when the TNC is turned on. The broadband noise usually can not be heard unless you observe the noise level in the presence of a weak signal. (With the normal antenna connect, inject a signal that provides 10 db of quieting then turn on the TNC and observe the change in noise level. If you have a 0.5 uv receiver or are in an otherwise noisy location you may not be affected. With a 0.2 uv receiver you may lose 6 db of quieting.)

#### CLEANING UP THE MFJ-1270B

Sufficient reduction in the energy emitted by the 1270B can be had with some relatively simple modifications to the 1270B. These modifications should reduce the broadband noise level to a insignificant level for most sites. Harmonics that cause problems to specific frequency can usually be moved far enough off frequency by 'rubbering' the crystal with the trimmer in the TNC.

1. Scrape the paint from the inside of the cover and the outside of the chassis near the four screws that hold the cover on.
2. Remove the circuit board from the chassis and scrape the paint from the top of the four posts that hold the circuit board.
3. Add a low inductance strap from the mounting hole near the power switch to the ground trace at the edge of the circuit card. (The bottom side of the card works the best.)
4. On the bottom side of the card add a 'small' 0.001 uf capacitor from each of the four active pins on the DIN connector to the ground foil immediately adjacent.
5. Add a ground strap from the foil on the bottom side of the card under

the DIN connector. The ground end of this strap can be left dangling until the card is reinstalled and then looped to the outside of the chassis and grounded with a small self tapping screw on the lip just below the DIN connector.

If you are at a shared site, you owe it to the other services to be a good neighbor.

AL, K0VM



From: wa2ise@cbnewsb.cb.att.com (robert.f.casey)  
Newsgroups: rec.radio.amateur.misc  
Subject: TR2400 repair notes, unwanted noise, low RX, display & keyboard  
Keywords: tr2400  
Message-ID: <1991Dec18.174853.23184@cbfsb.att.com>  
Date: 18 Dec 91 17:48:53 GMT  
Sender: news@cbfsb.att.com  
Organization: AT&T Bell Laboratories  
Lines: 96

The following are several articles crossposted from packet on the TR2400:

copied from packet:

| Msg# | TSF | Size | #Rd | Date   | Time | From  | MsgID        | To             |
|------|-----|------|-----|--------|------|-------|--------------|----------------|
| 318  | BF  | 847  | 0   | 13-Dec | 0440 | KD2EJ | 28983_WB2QJA | INFO@ALLBBS () |

Sb: TR-2400 NOISE PROBLEMS

PERMISSION GRANTED FOR RELAYING AS INDICATED ON KENWOOD BBS.

SB-809

TR-2400 Unwanted Noise: Tone or burst at tx 2-13-80

For complaints of a tone burst type noise, or simply a noise, at initial key down, suspect either a broken losse component, or incorrect valued component on the RX TX unit.

On the RX TX unit, Q16 emitter, check C82, a 33 uf tantalum cap for broken connection.

If you find a 22 uf cap at C82 replace it with a 33 uf cap.

JEB/yn  
(c) 21380TKC

=====  
Note: I haven't tried or verified this, proceed at your own risk. WA2ISE

copied from packet:

| Msg# | TSF | Size | #Rd | Date   | Time | From  | MsgID        | To             |
|------|-----|------|-----|--------|------|-------|--------------|----------------|
| 317  | BF  | 1183 | 0   | 13-Dec | 0443 | KD2EJ | 28984_WB2QJA | INFO@ALLBBS () |

Sb: TR-2400 DISPLAY & KEYBOARD

PERMISSION GRANTED FOR RELAYING AS INDICATED ON KENWOOD BBS.

SB-810

TR-2400 Display or Keyboard trouble 2-20-80

Display

An intermittent or blank digit may be caused by either a broken lead, or intermittently shorting lead on the PLL unit.

On the PLL unit, look in the area of Q12, the touchtone generator. Between Q12 and the board edge locate the D1-D4 lines. Inspect this area for either an open (Broken) lead, or shorted (pinched) lead. Repair as necessary, and check lead dress before reassembly.

#### Keyboard

An intermittent or inoperative keyboard row or column may be caused by a torn or pinched lead, or a cracked diode.

Again, in the area of Q12, inspect the "T" and "Y" lines for shorts or open connections, and inspect diodes D19-D26 for physical breakage.

JEB/yn  
(c) 22080TKC

=====

Note: I haven't tried or verified this, proceed at your own risk. WA2ISE

copied from packet:

| Msg# | TSF | Size | #Rd | Date   | Time | From  | MsgID        | To             |
|------|-----|------|-----|--------|------|-------|--------------|----------------|
| 316  | BF  | 1108 | 0   | 13-Dec | 0446 | KD2EJ | 28986_WB2QJA | INFO@ALLBBS () |

Sb: TR-2400 RX LOW & DISTORTION

PERMISSION GRANTED FOR RELAYING AS INDICATED ON KENWOOD BBS.

SB-811

TR-2400 RX low, INtermittent, or distorted 2-20-80

For any of the above complaints, suspect a broken loose component in the RX IF or audio output circuit on the RX TX unit. Simply pull up on the leads and resolder.

Adjacent to Q9, the audio output IC, find C49, a luf cap. If broken loose from the board, audio output may be down, while current consumption may be up from the normal 30mA to about 100mA due to the audio output amp oscillating.

Adjacent to L10, the discriminator, locate C33, a .033uf cap. If this component is broken loose, audio output may be up approximately 6 dB with excessive high frequency audio response.

JEB/yn  
(c) 22080TKC

=====

Note: I haven't tried or verified this, proceed at your own risk. WA2ISE





Article: 11297 of rec.radio.amateur.misc  
From: wa2ise@cbnewsb.cb.att.com (robert.f.casey)  
Newsgroups: rec.radio.amateur.misc  
Subject: TR7625 intermittant TX fix  
Keywords: tr7625  
Message-ID: <1991Dec18.175539.23513@cbfsb.att.com>  
Date: 18 Dec 91 17:55:39 GMT  
Sender: news@cbfsb.att.com  
Organization: AT&T Bell Laboratories  
Lines: 27

copied from packet:

| Msg# | TSF | Size | #Rd | Date   | Time | From  | MsgID        | To             |
|------|-----|------|-----|--------|------|-------|--------------|----------------|
| 320  | BF  | 881  | 1   | 13-Dec | 0435 | KD2EJ | 28981_WB2QJA | INFO@ALLBBS () |

Sb: TR-7625 INTERMITTENT TXMT.

PERMISSION GRANTED FOR RELAYING AS INDICATED ON KENWOOD BBS.

SB-804

TR-7625 Intermittent TX

2-7-80

When servicing a TR-7625 for mechanically intermittent TX, check the heavy WHITE DRB lead at the push-on connector directly in front of relay RL1 on the RX TX unit. This post may either become seperated from the land, or the land may crack from vibration. Resolder the post, plus reinforce the connection with a small piece of solid wire soldered on the foil side of the board.

JEB/yn  
(c) 2780TKC

=====

Note: I haven't tried or verified this, proceed at your own risk. WA2ISE



Date: Fri 1 Jun 90 13:43:04-EST  
From: POPYACK@TOPS20.RADC.AF.MIL  
Subject: TS-140S TX All Freq Mod

To enable the TS-140S for transmitting on all bands:

1. Disconnect radio from power supply and antenna
2. Remove top and Bottom covers
3. Locate the control board (I believe it is on the bottom --NOT BEHIND THE KNOBS LIKE THE 440!!)
4. Cut D31 on the control board
5. Reassemble the radio
6. Reset the radio by holding the A=B switch while powering up the rig.

Disclaimer: This Modification is for those who need it to operate MARS only.

From: wa2ise@cbnewsb.cb.att.com (robert.f.casey)  
Newsgroups: rec.radio.amateur.misc  
#Subject: TS140 intermittant loss of TX power fix  
Keywords: fix  
Message-ID: <1991Dec10.153807.21505@cbfsb.att.com>  
Date: 10 Dec 91 15:38:07 GMT  
Sender: news@cbfsb.att.com  
Organization: AT&T Bell Laboratories  
Lines: 32

copied from packet:

| Msg#                               | TSF | Size | #Rd | Date   | Time | From  | MsgID        | To             |
|------------------------------------|-----|------|-----|--------|------|-------|--------------|----------------|
| 8737                               | BF  | 1366 | 0   | 07-Dec | 0510 | KD2EJ | 28378_WB2QJA | INFO@ALLBBS () |
| Sb: TS-140 INTERMITTENT LOSS TMXT. |     |      |     |        |      |       |              |                |

SB-928

TS-140S Intermittent loss of TX power 4-11-88

In some TS-140S transceivers, the drive transistor, Q2, is not firmly mounted to the heatsink. This can cause a loss of transmit power after the unit warms up. The following modification will correct this condition.

1. Disconnect the TS-140S from the antenna and power supply.
2. Remove the top and bottom covers. Open the sub-chassis. Refer to the instruction manual for step by step instructions.
3. Remove the shield plate from the sub-chassis (12 screws) to expose the filter an final units. Do not loose the 2 springs that are secured by the right side screws.
4. Resolder Q2 so that the transistor makes firm contact with the heat sink on the Final unit. Tighten the transistor's mounting screw.
5. Assemble the transceiver by reversing steps 1 through 3.

This modification may be performed under warranty.  
Time required for this change is 1/2 hour or less.

(c) 121589TKC

=====  
Note: I haven't tried or verified this, proceed at your own risk. WA2ISE



From: wa2ise@cbnewsb.cb.att.com (robert.f.casey)  
Newsgroups: rec.radio.amateur.misc  
Subject: TS180s notes (long)  
Message-ID: <1991Dec8.191700.28212@cbfsb.att.com>  
Keywords: ts180  
Sender: news@cbfsb.att.com  
Organization: AT&T Bell Laboratories  
Date: Sun, 8 Dec 1991 19:17:00 GMT  
Lines: 277

The following is a series of notes on the TS180s  
copied from packet:

| Msg# | TSF | Size | #Rd | Date   | Time | From  | MsgID        | To             |
|------|-----|------|-----|--------|------|-------|--------------|----------------|
| 8510 | BF  | 1757 | 0   | 01-Dec | 0554 | KD2EJ | 27819_WB2QJA | INFO@ALLBBS () |

Sb: TS-180S USE W/LINEAR AMP.

SB-817

TS-180S Use with a Linear Amplifier 3-20-80

1. Fast Protection with a Linear:

For complaints of fast protection, such as when operating CW semi-break-in with a linear, check C73 at the base of Q1 on the LPF unit X51-1180-00. If it is a 1uf, change to 3.3 uf, 25v or greater. This will compensate for slow linear relay closure.

2. Premature Protection

The radio should protect at 3:1 SWR, or at 24W open (no) load. To test the protection circuit, load the radio at 24W into a know 500 ohm dummy load through a Bird 43 wattmeter. Disconnect the load from the wattmeter. The protection light should just lite. Adjust the protection pot VR1 on the LPF unit for protectio at 24W with no load.

3. For complaints of VOX CYCLING, MEMORY JUMP, READOUT JUMP, or TONE "BEEP" at key up or down with a linear amp, suspect linear induced relay transients entering the radio via the ASSY relay wiring.

For example, DRAKE L4B linears before Serial Number 5500 do not have a quench diode across the DC operated relay. Install a 1N4005 or equivalent across the relay in the linear to eliminate the back EMF induced by the linear into the TS-180S. Similarly, Henry linears also don't have a diode across the relay and may give these symptoms when operated with a TS-180S.

JEB/yn  
(c) 32080TKC

SB-803

TS-180S CW Delay During VOX Memory Operation 2-7-80

Some operators may report missing the first dit during CW VOX operation on the memories. This will occur only in early units, and may be improved by

changing one capacitor in the DFC.

On the DFC VCO unit X50-1550-00, check C3 at the base of Q3. If C3 is a 22uF electrolytic, change to a .01uf disc. No adjustments are necessary.

JEB/yn  
(c) 2780TKC

SB-055

TS-180S Low 40M ALC 9-14-79

Please annotate your service manual.

Some operators may experience intermittent reduction or loss of ALC, especially after several minutes transmit time.

On the LPF unit X51-1180-00, change C14, C17 from 470 pf to 390 pF. Check ALC level and adjust if necessary, per section 406 ALC meter adjustmet, TS-180S service Manual.

New part: CM93D2H390J 390pF +/- 5% 500v mica or ceramic

Please annotate your Service Manual.

JEB/yn  
(c) 91479TKC

SB-839

TS-180S VFO Stability 12-29-80

VFO drift characteristics may be improved by changing a capacitor value and location in the VFO.

1. Begin by calibrating the analog dial to the Digital Display at 14.000.0 MHz. DO NOT disturb this calibration while working on the VFO.
2. Turn off the main power and remove the VFO unit by two 3mm hex head bolts.
3. Withdraw out the front panel and unplug the leads.
4. Remove the VFO cover by five Phillips head screws.
5. Remove C17 from the PCB. This may be cut flush to the board.
6. Install the 18 pF yellow cap across the tank coil terminals. Position the cap near the coil.
7. To reassemble, performs steps 3, 2. Snug all VFO case screws. A later complaint of frequency jump would indicate a loose VFO shell.
8. Turn on the radio and check analog dial calibration against the Digital Display. Adjust VC1 (center of the Seal Tape) only if the zero-point has moved.



9. VFO linearity final check: The Digital readout and analog dial should agree to within +/- 2 kHz at every 100 kHz dial point.

New Part: 18 pF CC45RC1H180J  
Old Part: 18 pF CC45PG1H180J

#### Analog Dial Calibration

1. Calibrate the main knob to 50 kHz analog against the digital display.
2. Note the digital error. If it is more than 2 kHz adjust the VFO trimmer cap VC1 (center under the sealing tape) to exactly 50.0 on the digital readout.
3. Turn the main knob to 450 analog. If the digital error is less than 2 kHz it is in spec. If the digital error greater, proceed:

For instance, if the digital error is 14.454.0 (plus 4 kHz), multiply the error times 4 (16 kHz) and adjust the VFO trimmer cap to the desired frequency (14.450.0) LESS the error, or 14.434.0. Next, adjust the VFO inductor L1 (front under the sealing tape) back up to the desired frequency of 14.450.0.

4. If the error in step 3 was in the minus direction, reverse the direction of correction adjustment.
5. VFO linearity final check: The digital readout and analog dial should agree to within +/- 2 kHz at every 100 kHz dial point.

JEB/yn  
(c) 122980TKC

SB-047

TS-180S Increase of RX Audio Output 7-30-79

RX audio output from the TS-180S may be increased a total of 4.7 dB. This is an optional change which you can make at the owners request.

On the IF unit X48-1240-00 change components:

R206 2.2K change to 1 K ohm  
R207 2.2K change to 4.7 K ohm

On the AF Gain Control, between pin 1 and 3;

C4 .047uF change to .027uF mylar

Please annotate your service manual.

JEB/yn  
(c) 8679TKC

SB-042

TS-180S IF output #2 Level Change for SM-220 9-4-79

TS-180S owners who desire to operate an SM-220 for IF output display will require a wiring change to the IF unit X48-1240-00. No additional parts and no adjustments are required.

Remove R77, 470 ohm, and replace with wire jumper. Remove R78, 56 ohm, and replace with old R77. The 56 ohm resistor is not used.

With AGC on, gain should be adequate for about a 3/4 screen display.

JEB/yn  
(c) 71079TKC

SB-041

BS-8 Alignment with the TS-180S Transceiver

9-4-79

The SM-220/BS-8 scope combination are fully compatible with the TS-180S transceiver. However, as the TS-180S does not have a 25kHz calibrator, BS-8 alignment will not be in accordance with the SM-220 Operating Manual.

Procedure:

Install the BS-8 in accordance with the SM-220 Manual, however, leave the scope covers off until step 1 is completed (If input alignment.) See note 1.2.

Perform steps 8.4.1, 8.4.2. steps 8.4.3, 8.4.4 do not apply to the TS-180S. After step 8.4.2. continue:

1. With the Marker ON, turn the transceiver ON, and in the USB mode, any band, you should hear the scope Marker directly injected into the IF. Peak T201, the BS-8 input IF transformer, for maximum signal into the TS-180S. This transformer is not shown in Fig. 8-2, but is the only other adjustment on the BS-8, and is located below the three identified access openings. If you cannot hear the Scope Marker in the TS-180S, turn the marker off and tune a local station on the 1.5 MHz band. Peak the drive control, and then peak T1 in the BS-8 for maximum amplitude at scope center and equal roll-off at the display edges. See note 1 Page 2.
2. Turn of TS-180S, 1.5 MHz band, and tune to the local AM broadcast station nearest 1.6 MHz.
3. Enter this frequency in the M1 Memory. Depress the DSP/Diff pushbutton for a differential display.
4. Tune up and down approximately 100KHz, observing the scope display. Note the verticale displacement of the original frequency to the left and right. If equal, or linear displacement is obseved, stop.
5. If the display does not shift equally when tuned up or down frequency, adjust VR202 for linearity of scan width. Then reset to the center frequency (by the cope Marker or retuning the transceiver). Reset TC201 if necessary. Repeat two or three times for correct scope center frequency,

and linear display.

6. Turn the TS-180S off, and the scope marker on. Switching between 100khz and 20khz scan widths, the marker should appear at scope center, and should not shift. Repeat step 5 if there is a shift.

Notes:

1. A Bs-8 previously aligned to a TS-820 or TS-820S need only have step 1., input alignment, performed.
2. Preset TC201, VR201, VR202 at their center. When alignment is complete, these adjustments should not be at their extreme limits. This will result in unstable Pan display operation. Rather, they should be somewhat within their center range.

Please make these changes in your service manual.

JEB/yn  
(c) 9479TKC

SB-061

TS-180S Trouble Sheet 12-18-79

ALC deflection low Replace D21 on IF unit from 7.1 to 9.0V zener.  
Readjust all ALC pots.

IF #2 OUtput low Bridge R77 position, replace R78 with R77 470 ohms. See  
TKC service Bulletin.

RX Noise (OSC CAR leakage) Shorten L31, L33 leads as much as possible.

Increase NB effectiveness Replace L31, L33 for 33 uh to 27uh, with SHORT  
leads.

RX noise from strong signals Replace L30 10uh on the IF with self  
shielding type (new part L40-1035-21).

TX audio distortion Adjust T15 on the IF approx 1/2 turn back, readjust  
all ALC pots up.

10 M PLL unlock change: R77 from 6.8 K to 4.7 K ohm, R94 from 8.2 K to  
6.8 K ohm on the PLL unit.

TX audio distortion Adjust 10 W bias for 150ma, 100w bias for 100ma.

Unlocked all bands Check L2, (Q2 B+) in the PLL unit.

FM'ing with DFC See service bullein of 9/10 for L12, L13 change and add  
resistor and shield.

40 Mlow alc, See bulletin 9/14 change C14, 17.

JEB/yn

(c) 8979TKC

---

Note: I havent tried or verified this, proceed at your own risk. WA2ISE



From: wa2ise@cbnewsb.cb.att.com (robert.f.casey)  
Newsgroups: rec.radio.amateur.misc  
Subject: TH25 and 45 automatic power off defeat  
Keywords: mod  
Message-ID: <1991Dec10.044456.26533@cbfsb.att.com>  
Date: 10 Dec 91 04:44:56 GMT  
Sender: news@cbfsb.att.com  
Organization: AT&T Bell Laboratories  
Lines: 57

copied from packet:

| Msg# | TSF | Size | #Rd | Date   | Time | From  | MsgID        | To             |
|------|-----|------|-----|--------|------|-------|--------------|----------------|
| 8733 | BF  | 2759 | 0   | 08-Dec | 0330 | KD2EJ | 28521_WB2QJA | INFO@ALLBBS () |

Sb: TH-25-45AT AUTO POWER OFF.

SB-939

TH-25/45AT Automatic Power OFF Function

8-02-88

Some users of the TH-25AT/45AT have expressed a desire to defeat the automatic power off function. The following modification will explain how to do this. It should be noted that this modification does not effect the battery saver function.

Required Part:

Diode Kenwood Part #1SS133

1. Disconnect the battery pack and antenna.
2. Remove the Volume, Squelch, and Tuning Control knobs by pulling them straight up from the top panel.
3. Using a 7mm spanner wrench, remove the nut from the volume control and the nut from the tuning control.
4. Remove one screw located by the PTT switch.
5. ReMOve one screw located by the speaker jack.
6. Remove two screws from the battery terminal plate.
7. Carefully pull the front panel up from the transceiver (do not break the wires connected between the front panel and the body of the transceiver.) Lay the front panel to the side of the transceiver (Keep track of the F.LOCK cover if it comes off.)
8. Remove the PTT cover.
9. Remove one screw from the PTT switch unit.
10. Gently lift the top panel from the transceiver by pulling it forward and then up (the "O" ring on the BNC connector will produce some tension.)
11. Carefully unfold the flex Printed Circuit Board (PCB) to expose IC2.
12. Using a 45 watt (or less) soldering iron that has an isolated or grounded tip, add a diode between pins 23 and 58 of IC2.
13. Carefully assemble the transceiver by reversing step 1-11. Pull the BNC connector "O" ring up a little before installing the top panel.
14. Reset the microprocessor by following the procedure in the instruction manual (page 16) called CLEARING ALL MEMORY.

This is an optional change that is not covered under warranty.  
Time required for this modification is 1 hour or less.

SYSOP NOTES: Later versions of the TH-25/45AT came with a programmable defeat for the Auto power off function. Do not install this modification if your manual provides a procedure for turning the power off function off! Step 11 tells you to carefully unfold the flexible pc board. It is extremely important that you do not try and bend the board in a direction that is opposite from its current bend. To do so will break the board or the foil traces inside the board!

(c) 121589TKC

=====  
Note: I haven't tried or verified this, proceed at your own risk. WA2ISE





Date: Thu, 15 Jun 89 14:11:38 PDT  
From: beekman%a1\_utrop2.DEC@decwrl.dec.com  
Subject: Trio - Kenwood TS430 extended coverage

Author: Wim Beekman  
Date: 25-Oct-1988  
Posted-date: 25-Oct-1988

=====  
==

TRIO-KENWOOD mods and remarks  
-< Include 0-150kHz on your TS430 >-

-----  
--

This modification is to include the receiving range from  
the TS430 from 0-150 kHz.

Connect a resistor from 1K from IC1 pin 14 to ground in  
the PLL Unit.

(Pin 14 from IC1 goes to the base of a transistor.)

The best way to do this, is by soldering the resistor at  
the solder side of the PLL Unit PCB.

Peter -PA3AEF-

Newsgroups: rec.radio.amateur.misc  
From: ik3huk@sabrina.dei.unipd.it (Diego Serafin)  
#Subject: TS430 power fault - ANSWERS  
Message-ID: <BwuBHK.Kqw@dei.unipd.it>  
Sender: usenet@dei.unipd.it  
Organization: D.E.I. Universita' di Padova, Italia  
Date: Wed, 28 Oct 1992 16:36:56 GMT  
Lines: 135

Hi there !

As anticipated, I repost all the answers that came to me about TS-430 power  
fault. Thank You Very Very Much to everybody who sent suggestions and proposed  
solutions to the problem. I will open up the radio as soon as possible and  
do what suggested.

MNI TNX AGN ES BEST 73 de IK3HUK Diego. ...-.-

Follows my original posting and answers.

-----  
-  
-----  
-

>As you read in the subject I have some sporadic but very annoying troubles  
>with my 1988 Kenwood TS430s. This is what happens to my gear (and the same

>occurs to the rig of a friend of mine):  
>  
>Approx. every 3-4 hours of CW operation (while working without any problem)  
>the power output drops down to a few watt (typically during a pileup and when  
>the dx sent 'ik3huk 599...'). During this power-loss the ALC level is low  
>(regularly).  
>To have back the full power I have to do the following:  
>-Turn CARRIER knob fully clockwise (full power position - ALC doesn't move)  
>-Key down for several seconds (very loooooong time when in pileup)  
>  
>I sent the radio to a laboratory for repair (and friend of mine did the same)  
>but they're not able to reproduce the power-fault when the radio is on their  
>table. They cleaned up all the relays, but the RTX is still losing power.

This sounds suspiciously like a problem I had with my 430 on voice. It would behave quite similarly, losing power and becoming distorted on an occasional basis. There was a well reported problem with early 430's where the finals were riveted, but not soldered, and the rivets could eventually develop a high electrical resistance, with ensuing power problems. This was diagnosed and corrected by Kenwood early, so I doubt it would be a problem in a unit manufactured as late as yours. (I bought mine in late 1984, and it already had a modified PA -- believe me, I checked!)

My problem turned out to be a marginal connection in the internal switch on the XVTR jack on the back of the rig. This is the connector with 8 pins. The switch is integral to the connector and works when the plug is inserted. The fix was to insert and remove the plug in the jack several times. Since I have done this, my 430 has never shown this symptom again.

I wish I could claim to have deduced this myself, but it was pointed out to me by a friend who read it in a snippet from someone in QST. To whoever took the time to send in that suggestion, I am eternally grateful. Hope this solves your problem, too.

--  
Rob Stampfli rob@colnet.cmhnet.org           The neat thing about standards:  
614-864-9377   HAM RADIO: kd8wk@n8jyv.oh   There are so many to choose from.

-----  
-  
-----  
-  
To all Kenwood users:

The 430 has a corresponding problem to the older rigs:  
specifically the 520(S), 820(S), 530S, and 830S rigs....

Power drops while running... if this occurs, tighten the screws on the driver board and IF board.

Had this happen to me and friends a few times...also watch out for the coax connector on the back...they get loose too...no lock washer on the back.

73,  
Tom  
wb9rxj@uiuc.edu

-----  
--

-----  
--  
Diego,  
I had a similar problem with a 430. Mine was  
intermittent. Finally one cold day [0c] it  
became permanent. I traced my problem to an  
open via connection on one of the final transistor  
bases. This resulted in that device not getting  
a dc return to ground. I re-soldered the via to  
my success!

I found it by checking dc bias on each final trans-  
istor and found one being different in voltage reading.

Good luck,  
regards

George Hawkins  
-----  
--  
-----  
--

Here is a solution I heard of for a problem like yours. Perhaps it  
will be of use to you. Luckily, I have not had any problems with my  
TS430S. I'm very pleased with it.

Hope this is of use to you.

73 es GL.... Mark KG7JL  
-----

KD7EV advises intermittent power output problems on his '430 was  
cured by  
installing a more conventional nut on the rear panel UHF style  
antenna  
connector. Apparently a faulty ground connection at this point  
caused a change  
in the VSWR which affected the sensing circuit and thus reducing the  
RF output  
power.  
-----  
--  
-----  
--

Guarda che io ho lo stesso problema con un ICOM IC-745. Ogni tanto la  
c'e' una protezione che va in funzione e la potenza va giu'. Nel caso  
mio probabilmente c'e' un problema di corrente di fuga da compensare  
opportunamente, ma per te potresti provare a vedere se con una semplice  
vantola puoi risolvere il caso. Infine, tanto per confermare che per me  
i diavoletti che muovono gli elettronici esistono, il problema c'e' solo  
di estate, quando la temperatura esterna e' sopra i 20 gradi (... qui in  
Olanda). Faccio notare che dentro casa la temperatura e' circa la stessa.

Saluti

I0WTD-PA3FWP  
Stefano

(In this article Stefano I0WTD told that he had a similar problem on his IC745 and suggested to put a blower on the radio to solve it out. 'His' power fault happened only on summer. (mine in winter too !!) ik3huk)

---

-

Diego Serafin - IK3HUK  
ik3huk@sabrina.dei.unipd.it

-----]-----  
\_\_++\_\_\_\_\_/ \_]\_\_\_\_++\_\_



Subject: TRANSMIT ENABLE FOR MARS AND CAP FREQUENCIES FOR THE TS430S  
For MARS and CAP transmit capability, a minor change is required:

1. Unplug the DC power cable.
2. Remove the top and bottom covers of the set.
3. Locate the RF unit connector 10. Diode D39 is near the connector (labeled D39 on the circuit board). Take a small pair of diagonal cutters and clip the lead at the top of the bend.
4. Locate IC-2 on the Control Unit, under the IF unit. Resistor R148 is near IC-2, clip the resistor lead.
5. This completes the modification. Reassemble the unit, being careful not to pinch any leads.

\*\*\*->Be careful not to transmit out-of-band, or accidentally operate on any non-amateur, unless you are authorized to do so.

DO NOT JEOPARDIZE YOUR LICENSE!



Date: Tue, 17 May 88 17:09 EST  
From: <REID@IUBACS.BITNET>  
To: MBRAMWEL@BUSINESS.UWO.CDN

Subject: KENWOOD TS-440 Mod

West,Gordon: "Kenwood 440 Modifications" \_Popular Communica-  
tions\_, October 1987 p. 62.

Illustration captions:

1. Remove 17 screws holding on the bottom and top covers. The bottom cover comes off, and the top cover is carefully removed and put next to the radio. It is till connected via the speaker wire.
2. Gain access to the front of the unit by removing two top side screws and loosening two bottom side screws. This allows the front assembly to swing open.
3. Remove the shiny silver control board protection plate. This requires removing two screws on the top and three screws on the bottom. Lift the plate out completely.
4. Locate diode D-80 in the bottom left-hand corner. Snip it for all-band transmit.
5. Now locate D-66 and snip. It adds 10 Hertz readout to your digital frequency display.
6. Carefully reassemble the control plate using a magnetized tiny screwdriver to hold the five tiny screws in place. Don't pinch any wires. Also, close up the front and replace the top and bottom covers with 17 screws.
7. Connect power. Depress A=B switch and turn on the power simultaneously. This resets the microprocessor for all-band transmit and 10 Hz frequency display.

This article also tells how to increase the power of the TS-440 by adjusting the internal ALC control. The procedure is applicable to other rigs.

--

Frank W9MKV  
bitnet: reid@iubacs  
arpa: reid@gold.bacs.indiana.edu

From: wa2ise@cbnewsb.cb.att.com (robert.f.casey)  
Newsgroups: rec.radio.amateur.misc  
#Subject: TS440 Q33 protection  
Keywords: fix  
Message-ID: <1991Dec10.045038.26685@cbfsb.att.com>  
Date: 10 Dec 91 04:50:38 GMT  
Sender: news@cbfsb.att.com  
Organization: AT&T Bell Laboratories



Lines: 59

copied from packet:

| Msg# | TSF | Size | #Rd | Date   | Time | From  | MsgID        | To             |
|------|-----|------|-----|--------|------|-------|--------------|----------------|
| 8731 | BF  | 1957 | 0   | 08-Dec | 0343 | KD2EJ | 28523_WB2QJA | INFO@ALLBBS () |

Sb: PROTECTING Q-33 ON TS-440S

SB-949

TS-440S PROTECTI 01/20/89

If pin 7 (RL) of the remote connector is accidentally connected to ground, current from the 14 volt line (14L) will damage transistor Q33 on the IF unit. This will prevent the radio from transmitting. To protect Q33, a 4.7 ohm resistor should be installed in series with the RL line on the foil side of the IF board. In the event that pin 7 is connected to ground, the resistor will open, but the transceiver will still be capable of transmitting.

REQUIRED PART:

4.7 OHM, 1/6 WATT RESISTOR ..... RD14CB2C4R7J

1Disconnect the power supply and antenna from the transceiver.

2Using a #2 Phillips screw driver, remove the 9 screws from the top cover of the transceiver. Remove the cover and unplug the speaker wire.

3Locate connector 19 on the IF unit.

4Using a #1 Phillips screw driver, remove the 7 screws that secure the IF unit to the chassis of the transceiver.

5Pull the board up and rotate it towards the front of the transceiver to expose the foil side of the board.

6On the foil side of the board, locate the trace that is connected to pin 3 (brown wire) of connector 19.

7Using a craft knife, cut the trace comming from pin three so as to open the foil trace.

8Solder the 4.7 ohm resistor across the now open trace (i.e. in series with the trace).

9Assemble the transceiver by reversing steps 1 - 5.

This is an optional change that may not be covered under warranty.

Time required for this modification is 0.5 hrs or less.  
(C) 112188TKC

=====  
Note: I haven't tried or verified this, proceed at your own risk. WA2ISE



Newsgroups: rec.radio.amateur.misc  
From: wa2ise@cbnewsb.cb.att.com (robert.f.casey)  
Subject: TS440 receiver audio mods file  
Message-ID: <1993Mar24.130853.8959@cbfsb.cb.att.com>  
Keywords: mods  
Sender: news@cbfsb.cb.att.com  
Organization: AT&T  
Date: Wed, 24 Mar 1993 13:08:53 GMT  
Lines: 29

copied from packet:

| Msg#                     | TSF | Size | #Rd | Date   | Time | From  | MsgID       | To           |
|--------------------------|-----|------|-----|--------|------|-------|-------------|--------------|
| 38513                    | BF  | 1520 | 0   | 19-Mar | 2236 | N2FAM | 2890_WA2OLZ | MOD@USBBS () |
| Sb: TS-440 RX Audio Mods |     |      |     |        |      |       |             |              |

Here's some easy modifications to improve the rx audio fidelity of Kenwood TS-440's. All references below are to the IF board component designations.

\* Increase C60 to a .47uf or 1 uf. This will increase low frequency response on all modes.

\* Decrease C51 to .01 uf. This will increase high frequency response on SSB/CW.

\* Try removing R263 (tacked on the bottom of the board on my early production unit). This will lower in amplitude the audio coming out of the detectors and improved the smoothness (a real technical term) of the audio, especially on AM signals.

And, of course, I take no responsibility for anything you do to your radio. Be careful. The IF board on the 440' is about the easiest one to get at.

73/Dave n2fam@ka3fmo.pa

=====  
Note: I haven't tried or verified this, proceed at your own risk. WA2ISE



Subject: TS-440S MODIFICATION TO USE ANTENNA TUNER FOR XT AND RX.-

Remove case from rig. Remove (4) screws that holds antenna tuner in place. Next slide antenna tuner out to get to the coax connections. Remove the input coax attached to antenna tuner from FO connector on filter unit (X51-340-00). Remove coax from out connector on antenna tuner and install in FO CONNECTOR ON FILTER UNIT. Unplug and remove switch unit (X41-1610-00 N-14) from rig. Remove short wire from antenna connector to PC BOARD. Cut coax on the input connector of antenna tuner in half and connect cut the end to switch unit PC BOARD where short antenna wire was removed and shield to ground. Solder other half of coax to antenna connector and shield to ground, and plug other end into output connector of antenna tuner. You still have control of antenna tuner with auto and thru switch.

It works very well. Maybe someone can use this idea.  
N2EDE, Box 680-S, Roanoke, VA. 24012.







From: ms86817@cs.tut.fi (Matti Suokko (OH5MRM))  
Newsgroups: rec.radio.amateur.misc  
#Subject: TS-450/690 TX mod.  
Message-ID: <1991Dec24.211911.7355@funet.fi>  
Date: 24 Dec 91 21:19:11 GMT  
Sender: usenet@funet.fi (#Kotilo NEWS system )  
Organization: Tampere University of Technology  
Lines: 14  
Originator: ms86817@cs.tut.fi  
Nntp-Posting-Host: cs.tut.fi

Remove D21 in PLL-UNIT (X50-3150-xx)

73 de Matti OH5MRM

P.S. This modification has not been tested.  
I take NO responsibility or liability for any damage or  
violation resulting from this modification.

--

Matti Suokko  
Mekaniikanpolku 6 A 36  
SF-33720 TAMPERE  
949-626362 (24h)

OH5MRM  
packet radio: OH3MRM@OH3RBR.#TRE.FIN.EU  
Internet: ms86817@cs.tut.fi  
VTTS-member



Newsgroups: rec.radio.shortwave,rec.radio.amateur.misc  
From: roy@well.sf.ca.us (Roy Harvey)  
Subject: TS-50 Power Mod for QRP  
Message-ID: <C3zuE5.8Fu@well.sf.ca.us>  
Sender: news@well.sf.ca.us  
Organization: Whole Earth 'Lectronic Link  
Date: Tue, 16 Mar 1993 18:08:29 GMT  
Lines: 40  
Xref: elroy.jpl.nasa.gov rec.radio.shortwave:22157  
rec.radio.amateur.misc:36032

"Honey - I Shrunk the Rig"  
by Bob Gobrck WA6ERB

No this is not an article about Kenwood shrinking their new TS-50 HF rig into a "CB" sized package, but the "shrinking" of the low power level on the TS-50 from 10 watts to 5 watts output in order to "officially" comply with the nationally recognized QRP power level for contest operation.

Prepare yourself before you remove any covers from the TS-50 - this is no Hallicrafters (feel a little dated) with 6L6's glowing in the inside. All components are surface mounted and to conserve space surface mounted subassemblies stand up at right angles all over the place. No place to work with that stubby tipped Weller soldering gun. But have no fear, this QRP mod is simple - you just need a screwdriver with a blade the size of a toothpick.

If you check the schematics you will see on the TX/RX board two potentiometers to set the Low 10 watt (pot VR15) and Medium 50 watt (pot VR16) power levels. The high power level is fixed at 100 watts by resistor R214. Our goal is to get to VR15 and set it for a 5 watt output.

First remove the top cover, set aside speaker and remove the latched speaker bracket (gives you better operating room). Locate two teeny-weeny pots next to IF filter module in the middle of the TX/RX board. The pot closest to the front panel is VR15 (low power adjust) and the one closest to the back of the rig is VR16 (medium power adjust) - the pots are somewhat marked on the PC board. Hook up a QRP wattmeter, dummy load and power and while in the low power mode adjust the pot (I used a flat blade calibration tool I had around) for 5 watts. That's it. You may notice that you can crank the pot all the way down to 0 watts so set where you want. I suspect the medium power adjustment with VR16 can also go to zero so maybe you can go QRPp by setting the low power pot for 999 mw and the medium power pot for 5 watt.

PS: Kenwood Service cautioned that their automatic antenna tuner requires 10 watts to actuate so this adjustment may affect that operation. You may want to check if Kenwood actuates the low power mode when the antenna Tune button is pressed. Also don't expect to run this rig off of a small solar cell for field day - the unit and all of it's surface mounted components draws a bit of power - enough for the internal fan to come on even in the QRP low power mode.

Newsgroups: rec.radio.amateur.misc  
From: wa2ise@cbnewsb.cb.att.com (robert.f.casey)  
#Subject: TS50 extended transmit mod file  
Message-ID: <1993Mar24.130552.8427@cbfsb.cb.att.com>  
Keywords: mods  
Sender: news@cbfsb.cb.att.com  
Organization: AT&T  
Date: Wed, 24 Mar 1993 13:05:52 GMT  
Lines: 38

copied from packet:

1783 1 19-Mar 2227 KA4RKT 14874\_MTPASW MOD@USBBS ()  
Sb: TX Coverage mod TS-50

Hi folks,

I just got a spanking new Kenwood TS-50S

Searching around the local LLBBS's I found a very simple mod for full transmit from 1.7 - 30 mhz....

Remove the bottom cover of the TS-50

Locate the PLL board -- it is the pc board on top of the main board, it has a shield on it's right side.

Locate the only non-surface mounted component on the PLL board -- look near the rear left-hand side of the pll board (front of radio facing you) and remove the very obvious diode. You can't miss, ther's only one.

Replace cover.

Perform microprocessor reset as described in your manual.

Please -- This mod for use only by persons authorized to use those frequencies outside of the ham bands - such as MARS, CAP and such. This radio is not type accepted for commercial use outside of the ham bands....

Tom  
KA4RKT @ WB4TTZ-1

=====  
Note: I haven't tried or verified this, proceed at your own risk. WA2ISE



From: wa2ise@cbnewsb.cb.att.com (robert.f.casey)  
Newsgroups: rec.radio.amateur.misc  
Subject: TS520 service notes  
Keywords: troubleshoot  
Message-ID: <1991Nov24.170347.29597@cbfsb.att.com>  
Date: 24 Nov 91 17:03:47 GMT  
Sender: news@cbfsb.att.com  
Organization: AT&T Bell Laboratories  
Lines: 137

copied from packet:

| Msg#                    | TSF | Size | #Rd | Date   | Time | From  | MsgID        | To            |
|-------------------------|-----|------|-----|--------|------|-------|--------------|---------------|
| 8166                    | BF  | 4244 | 0   | 24-Nov | 0152 | KD2EJ | 27230_WB2QJA | ALL@ALLBBS () |
| Service notes on TS-520 |     |      |     |        |      |       |              | 10-21-77      |

#### TRANSMITTER

1. No switching of final relay: Bad Q8 on X54-0001-00 2SA562Y.
2. No drive: C3 100pf in final box is cold soldered.
3. Low output: Check the plate load cap for touching plates.
4. 3.5 MHz low output: Replace burned 47pf 3KV at load wafer.
5. No TX: Final choke burned out in final VOX L8.
6. No RX or TX: Bad common amp. Q1 3SK35GR in IF unit X48-1060-00.
7. No ACC: No plate current Q2 3SK41 If unit X48-1060-00.
8. No TX relay: Q8 2SA562Y on VOX unit. Also R18 1K resistor relay control.
9. No TX or RX: Check 9 volt terminal on FIX AVR (X43-1100-00) is loose.
10. No CW TX: Bad 9 volt regulator. Check D3 WZ061 on X43-1100-00.
11. No TX: Solder touch between TIF and key terminal on X44-1080-00.
12. No drive to TX: Check RL1 on GEN unit, small reed relay (X52-0010-01).
13. No ALC meter action on 10 meters: This is normal for TS-520.
14. CW chirp: Q4 2SA606L on Fix channel AVR X43-1100-00.
15. ALC meter to maximum when TX: RFI terminal at X44-1080-00 is not soldered.
16. No TX output: 82pf 3KV in final is burned.
17. No TX output: Q3 on RF unit 3SK41 X44-1080-00.
18. No bias: 10 ohm cathode resistors burned in final VOX.

19. No drive or TX output: R70-71 RF unit, R5 Rectifier unit.
20. No VOX: Q8 in VOX unit X54-0001-00.
21. No TX: 12BY7 is bad. Shorts and burns out. R71 and 70.
22. No carrier output: Q1 on Carrier X50-0009-01.
23. No drive - no screen voltage: R5 470 ohm open on rectifier X43-1090-00.
24. No drive - no ALC: Q2 3SK35Y IF unit. Q3 3SK41L RF unit.
25. No RF output: C13 0.04uf at pin 1 of S2001A is bad.
26. Low mic gain: Q1 2SC1000 on Gen unit.
27. No TX: Misconnection of brown wire after installation of CW filter.

#### RECEIVER

1. Low Sensitivity: Touching RLT and 9V at function switch.
2. Receiver sensitivity: No -6v at AVR: Q8 2SC735 on X43-1100-00 is bad.
3. Frequency Shift: Bad carrier Xtal 3395 on carrier unit.
4. VFO drift: C6 22pf, VFO unit.
5. No receive: Bad Q4, 3rd IF amp 3SK35GR on X48-1060-00.
6. Receiver sensitivity and bias current jump, -6v unstable: T1 oscillator transformer for -6v is bad on X43-1100-00.
7. Erratic AGC action: C11 100uf 16Von X431100-00. Fix channel AVR is bad.
8. Frequency shift when warmed up: Q1 in VFO 3SK22GR.
9. No RX or TX: IF unit C59 touch to T12 IF transformer.
10. Receiver noise: Q5 3SK35Y X44-1080-00.
11. Receiver sensitivity down: NBI terminal is pulled loose. Receiver at IF board.
12. No S meter reading and RF gain CCW. No meter deflection: Q3 on IF unit. Q5 on RF unit.
13. VFO frequency jumped: There is loose tension inside VFO.
14. VFO frequency shift: Cold solder of VFO output lead to VFO output socket.
15. Blows fuse when first on: Check Q1 and Q2 DC-DC converter transistor. One is possibly shorted.

16. Noise blanker inoperative: R6 4.7K resistor is broken at Q2 on X54-1080-10.
17. Loud audio squeal: Q4 3SB473 on X49-0008-01 shorted.
18. Low receiver sensitivity: Diode D4 1S1587 on RF unit.
19. VFO intermittant: Wire to L1 in VFO is not soldered.
20. No receive: Q4 3SK35Y, Q5 3SK35GR on RF unit.
21. No receive: Q9 3SK35GR on IF unit.
22. Hash noise in receiver: Q3 on RF unit 3SK41.
23. Blows fuse: C31 power supply is shorted, 100uf 500v. Also check associated diode D3, D4.
24. No RX on all bands: WWV switch is broken or a wire is loose or not soldered.
25. Receiver sensitivity: Q5 on RF amp 3SK35Y.
26. Receiver sensitivity: NBO terminal on X48-1060-00 is loose.
27. Low audio: Check for purple wire touch to ground at 12 pin connector in rear panel.

(c) 102177TKC

Copyrighted Kenwood U.S.A. Corp.

Relayed with permission from Kenwood U.S.A.

---

I haven't tried or verified this, proceed at your own risk. WA2ISE

From: wa2ise@cbnewsb.cb.att.com (robert.f.casey)  
Newsgroups: rec.radio.amateur.misc  
#Subject: TS520S service note: -6v supply  
Message-ID: <1991Nov30.040656.19491@cbfsb.att.com>  
Keywords: ts520  
Sender: news@cbfsb.att.com  
Organization: AT&T Bell Laboratories  
Date: Sat, 30 Nov 1991 04:06:56 GMT  
Lines: 27

copied from packet:  
SB-043

TS-520S -6v Supply Failure

8-9-79

When troubleshooting a TS-520S, check all power supply voltages, including the -6v DC supply. Symptoms such as dead, blown 2A DC fuse and now dead, low RX, no TX, or similar may occur after switching between 80 and 40M.

Cause of failure may be traced to an intermittent shorting between the 14v



dc and -6 dc supplies as the band switch is rotated between 40 and 80 meters. This will weaken or destroy D8, a 6v zener on the FIX CH AVR unit. To prevent repeat failures, break the White lead and install a 22 K ohm 1/2 watt resistor at the bandswitch S5-6, between the -6v supply line and switch terminal. An of course replace D8 on the FIX CH AVR unit, X43-1100-00

New Part: 22 k ohm 1/2 W carbon resistor

Please annotate your service manual.

JEB/yn  
(c) 8979TKC  
COPYRIGHTED KENWOOD U.S.A.

=====  
Note: I haven't tried or verified this, proceed at your own risk. WA2ISE

From: wa2ise@cbnewsb.cb.att.com (robert.f.casey)  
Newsgroups: rec.radio.amateur.misc  
#Subject: TS520/S service note on CW mode  
Keywords: ts520  
Message-ID: <1991Nov30.041026.19604@cbfsb.att.com>  
Date: 30 Nov 91 04:10:26 GMT  
Sender: news@cbfsb.att.com  
Organization: AT&T Bell Laboratories  
Lines: 20

copied from packet:  
SB-046

TS-520/520S CW Frequency Shift 8-6-79

Reports of intermittent frequency shift during CW operation, on the order of a few hundred cycles, may be traced directly to the Carrier Unit.

On the Carrier unit X50-0009-01, install a ground lead of #18 tinned wire or similar, between the cases of T1 transformer and X3, the LSB XTAL. Recheck frequencies after installing this ground lead.

Please annotate your service manual.

JEB/yn  
(c) 8679TKC  
COPYRIGHTED KENWOOD U.S.A. CORP.

=====  
Note: I haven't tried or verified this, proceed at your own risk. WA2ISE



From: wa2ise@cbnewsb.cb.att.com (robert.f.casey)  
Newsgroups: rec.radio.amateur.misc  
Subject: TS530 WARC bands mod file  
Keywords: mods  
Message-ID: <1991Nov23.202841.19369@cbfsb.att.com>  
Date: 23 Nov 91 20:28:41 GMT  
Sender: news@cbfsb.att.com  
Organization: AT&T Bell Laboratories  
Lines: 36

copied from packet:

| Msg# | TSF | Size | #Rd | Date   | Time | From  | MsgID      | To        |
|------|-----|------|-----|--------|------|-------|------------|-----------|
| 8078 | BN  | 2633 | 0   | 16-Nov | 0149 | KC2AR | 32545_WF2A | SWL@ALLUS |

MODIFICATION FOR THE KENWOOD TS-530  
----- WARC BANDS

AS SUPPLIED, THE TS-530 WILL RECEIVE BUT NOT TRANSMIT ON THE THREE NEW WARC BANDS. IF TRANSMIT CAPABILITY IS DESIRED, A MINOR WIRING CHANGE IS REQUIRED.. THERE ARE JUST TWO MINOR CHANGES THAT COULD BE MADE AND THEY ARE AS FELLOWS .....

1 --- FOR ALL 3 BANDS . BREAK THE LINE BETWEEN THE RF UNIT X44-1360-01 CONNECTOR #6, PIN #1 (TOP TERMINAL) AND AF UNIT X49-1150-00, CONNECTOR #7, PIN #4 (TOP TERMINAL).

2 --- OR, FOR INDIVIDUAL BANDS. ON THE RF UNIT X44-1360-01:

| BAND     | REMOVE/CUT |
|----------|------------|
| 10 MHZ   | D4         |
| 18 MHZ   | D5         |
| 24.5 MHZ | D6         |

I DID THE FIRST MODIFICATION AND FOUND IT TO BE THE BEST WAY TO GO, GOOD LUCK AND HAPPY HAMMING !

DE KC2AR BOB IN STARRUCCA, PA.

-----  
Note: I haven't tried or verified this, proceed at your own risk. And don't transmit outside of legal bands! WA2ISE



Subject: TS680 Freq Extend mod

THIS MOD WILL ALLOW OUT OF BAND TRANSMIT ON THE KENWOOD TS-680-S.  
REMOVE THE BOTTOM COVER. IN THE MIDDLE OF THE BOARD IS A DIODE MARKED D-31  
JUST CLIP IT AND REINSTALL BOTTOM COVER. THIS WILL ALLOW TRANSMIT FROM  
1.6 MHZ TO 33 MHZ AND 49 MHZ TO 56 MHZ. I HAVE NO OTHER MODS FOR THIS RADIO AT  
THIS TIME. I AM STILL TRYING TO FIND WHERE THE MISSING 10 MHZ FROM 35 TO 45  
AND WILL POST IT IF IT IS POSSIBLE.

73 CARL

Packet: VE3ZCO@VE3GYQ BBS

Internet: VE3ZCO@ardsley.BUSINESS.UWO.CA



Date: 12 Aug 90 03:05:48 GMT  
From: portal!cup.portal.com!Steve\_M\_Kile@apple.com  
Subject: Kenwood TS-680 mods  
To: info-hams@ucsd.edu

The following mods appeared on a local ham radio BBS. This is the first I have seen of these mods, has anyone tried them? Do they also apply to the TS-140?

TS680s Squelch modificatios - adds squelch to all modes

Parts required

1 each 100 uF 20 v capacitor  
1 each 10k ohm 5% 1/4W resistor  
2 each 1N914 small signal diodes

Modification:

All modifications are to the signal board. Remove the signal board to gain access to the bottom of the board.

Remove R178 100 ohm resistor. (I cut the land between C177 and R178) (Removes FM chip control voltage) R178 is on the bottom of the board.

Add jumper with a diode in series between IC6 pin 14 and the base of Q57. Cathode of the diode goes to the base. (This is the squelch trigger control voltage) Q57 is on the bottom of the board.

Connect a diode between the 8V line (very near IC6) and pin 4 of IC6. This activates the FM chip (IC6) all of the time. Cathode goes to pin 4, anode to the 8 volt line.

Connect a 10 k ohm resistor between IC6 pin 4 and IC6 pin 14.

Connect a 100 uF 25 volt capacitor between IC6 pin 14 and ground. (This slows this quick squelch down a little bit)  
Tests have shown (using commercial communications monitor) that activating FM chip IC6 does not degrade IF strip performance at all.

I have had this mod in my 680 for a bout year and a half and is still working great!

TS-680 6 METER POWER OUTPUT INCREASE

Adjust VR15 (50M) control on the SIGNAL UNIT board while monitoring 6 meter transmit power out put into a 50 ohm dummy load. I adjusted mine while also monitoring the ALC level to insure that I still had some ALC action. Using this method I have increased my 6 meter power output to appx. 25 watts.

Broadcast Sensitivity Modification for the TS680S / 140S

Between .500 and 1.6 MHz attenuation is added to reduce? front-end overload on the Broadcast band. Some of us BCB DXers find this a HIGHLY undesirable feature. If I want attenuation I will use the front panel switch. The following mod will restore the sensitivity - Cut the land between IC1 pin 11 and R7 (SIGNAL UNIT, M54581P)

Cut the trace between IC1 pin 12 and R10

Add a small signal diode (1N914, 1N4148) between IC1 pin 11 and R7 (Cathode towards R7)

Add a small signal diode between IC1 pin 12 and R7 (Cathode towards R7)

Trace the lands from pin 11 and 12 of IC1 and you will find a good place (to the left of connector CN5) to cut these traces as well as pad to solder the diodes to.

WOW WHAT A DIFFERENCE!!!!!!

If any new mods come up or enhancements of this one please contact me!!

73, WB5HJV

David A. Underwood  
9705 Caffrey  
Houston, Texas 77075

=====

Steve - N0FBL

steve\_m\_kile@cup.portal.com

-----





Subject: Kenwood TS-711A Mod

Kenwood TS-711: To expand coverage to 141.0 - 150.995mhz.

Cut D34 on control unit, and then reset the microprocessor.



Subject: TS-790A X-Band Repeat Mod

CROSS BAND REPEATER MOD

To operate the TS790A in the repeater cross band mode, diode D32 on the control board must be opened. In addition, two resistors must be soldered to a 13 pin din plug which will be connected to the ACC. 2 jack on the back panel of the transceiver.

TO LOCATE AND OPEN D32

- 1 Disconnect the power supply and antenna from the radio.
- 2 Remove the 14 screws that secure the top and bottom covers.
- 3 Carefully remove the top and bottom covers.
- 4 Locate the control board. this is a vertically mounted board that is positioned approximately 1 inch behind the front panel.
- 5 Locate diode d32 towards the top right side of the board.
- 6 Using a small pair of wire cutters, cut the lead of the diode. do not pull on the lead or the diode as this may tear the foil on the other side of the board.
- 7 assemble the radio by reversing steps 1-3.

13 PIN DIN PLUG CONFIGURATION.

- 1 Using a small flat blade screwdriver, lift up on the tab of the nylon cover.
- 2 Once the tab clears the slot of the metal holder, pull the cover off the plug.
- 3 Carefully separate the two metal holders and remove the pin assembly.
- 4 First tin pins 1, 8 and 11 of the assembly so the resistors can easily be soldered in place.
- 5 SOLDER A 100K ohm, 1/4 watt resistor between pins 1 and 11 of the assembly (the resistor leads should be cut and shaped before soldering).
- 6 Solder a 1.5K ohm, 1/4 watt resistor between pin 8 and the lead of the 100K ohm resistor that is attached to pin 11. (the resistor leads should be cut and shaped before soldering)
- 7 Wrap a small piece of electrical tape around the resistors. This will insulate them from the metal holder after the plug is assembled.
- 8 Mount the pin assembly in the two metal holders.
- 9 Slide the cover over the plug until the tab engages in the slot. The "U" shaped strain relief will not be used.
- 10 Plug the 13 pin din plug in the ACC2 jack on the back panel of the radio.

## OPERATING PROCEDURES

The repeater cross band operation allows the TS790A to receive on one band and re-transmit the signal on the other band. Incoming signals will automatically be switched to the sub band. The TS790A will then re-transmit the signals from the main band. Each band may contain offset and sub-audible tone information (an optional TSU-5 must be installed in EACH BAND for decode).

- 1 Press the MAIN function switch to select the MAIN band.
- 2 Select the first operating frequency and mode (fm only). Select the offset as required.
- 3 If the CH.Q is on, press the CH.Q switch to turn the function off.
- 4 Select the sub-audible tone as required .
- 5 Transfer the contents of the MAIN band to the SUB band.
- 6 Select the second operating frequency and mode (FM ONLY) and turn the CH.Q off.
- 7 Select the offset and sub-audible tone as required.
- 8 Adjust the MAIN and SUB band squelch controls to the threshold point. The TS790A will transmit in the repeater crossband mode if the squelch controls are set too low or a signal is received.
- 9 Adjust the power control to allow normal output power from the MAIN band.
- 10 Adjust the sub band volume control to a normal listening level to monitor incoming signals.
- 11 To place the radio in the repeater cross-band mode, press the F. switch and then press the M.IN switch. An asterisk will light in the MAIN band display for confirmation.
- 12 To cancel the operation, repeat step 11 and disconnect the DIN plug.
13. If the DIN plug is left in place after use, bleedover from the SUB band audio if present will be mixed with any transmitted audio. This will make your audio during a conversation hard to understand.

## TSU-5 TONE UNIT

When the TSU-5 tone units are not installed, only the tone (encode) function can be used.

If CTCSS is to be used it must be installed in both bands to function with the cross-band repeater mode.

## TX AUDIO ADJUSTMENT

The audio gain can be adjusted by variable resistor VR36 on the IF unit.

If the range of VR36 does not suffice for normal transmit audio, the values of the resistors on the 13 pin din plug can be changed. as an example, if the audio is too low, reduce the value of the 100K ohm resistor and increase the value of the 1.5K ohm resistor.

#### TO ACCESS VR36

- 1 Remove the bottom cover of the radio to expose the IF unit.
- 2 locate VR36
- 3 Use a plastic alignment tool to adjust VR36 for normal TX audio.
- 4 After the audio is adjusted, install the bottom cover.

73 AND HAPPY MODING

CARL

packet: VE3ZCO@VE3GYQ BBS

Internet: VE3ZCO@ardsley.business.uwo.ca



From: wa2ise@cbnewsb.cb.att.com (robert.f.casey)  
Newsgroups: rec.radio.amateur.misc  
Subject: TS820 Receive AUX band installation  
Keywords: ts820  
Message-ID: <1991Nov30.041525.19740@cbfsb.att.com>  
Date: 30 Nov 91 04:15:25 GMT  
Sender: news@cbfsb.att.com  
Organization: AT&T Bell Laboratories  
Lines: 63

zopied from packet: from kd2ej  
Installing AUX Band in TS-820 (RX only)  
01-18-77

The following information is for the installation and alignment of the AUX band in the TS-820. This extra band will be for receive only. Reference will be made to schematics and board layouts as shown in the Service Manual.

#### INSTALLATION

1. Remove the top and bottom covers.
2. Remove the Connectors from the PLL Assembly.
3. Remove the PLL assembly and set it aside.
4. Use the board layout of the Coil Pack to locate the positions for the ANT and MIX coils on the Coil Pack.
5. Install the ANT and MIX coils on the Coil Pack.
6. Remove both covers from the PLL Assembly.
7. Remove the 5 Phillips head screws holding the PD Unit in the PLL assembly and carefully remove the PD unit.
8. Use the board layout of the PD unit to locate Q11.
9. Install R01, R02, C01, C02 and X01 as needed for the band desired.
10. Locate terminals AUX, B1, B2, B3, and B4 on the PD unit.
11. Install a jumper from the AUX terminal to the B terminal for the band desired. B1 is for 1.8 MHz to 9 MHz, B2 is for 10MHz to 18MHz, B3 is for 19MHz to 24MHz and B4 is for 25MHz to 30MHz.
12. Replace the PD unit in the PLL Assembly.
13. Use a 3mm nutdriver to remove the 4 hex nuts mounting the VCO unit in the PLL assembly, then remove the two Phillips screws.
14. Carefully remove the VCO unit from the PLL assembly.
15. Use the board layout of the VCO unit to locate Q11.
16. Install C01, C02, C03, C04, C05, and T11 as needed for the band desired. Install T11 last.
17. Replace the VCO unit in the PLL assembly.
18. Install the connectors on the PLL assembly.

#### ALIGNMENT

1. Turn on the TS-820.
2. Tune VFO to 250.
3. Set band switch to AUX.
4. Set the TUN/NOR switch on the VCO unit to TUN.
5. Connect a frequency counter to terminals TP5 and TP6 on the VCO unit. (TP6 is ground).
6. Adjust T11 for a frequency of 9.08 MHz plus the lower limit of the band desired.
7. Connect a frequency counter to TP4 and ground on the PD unit, and



- verify the frequency of the reference oscillator. It may vary +/- 500KHz.
8. Return the TUN/NOR switch on the VCO Unit to the NOR position.
  9. Turn off the TS-820S.
  10. Replace the covers on the PLL assembly and reinstall it in the transceiver.
  11. Replace the top and bottom covers on the TS-820S.

CAUTION

Do not use magnetized tools when working on the PLL assembly. Beryllium tools would be better than ferrous ones. If the PLL assembly should become magnetized, use a bulk tape eraser on open core AC transformer to demagnetize it.

(c) 090277TKC

COPYRIGHTED KENWOOD U.S.A. CORP.

=====  
Note: I haven't tried or verified this, proceed at your own risk. WA2ISE

From: wa2ise@cbnewsb.cb.att.com (robert.f.casey)  
Newsgroups: rec.radio.amateur.misc  
#Subject: TS820 CW filter select control mod file  
Keywords: ts820  
Message-ID: <1991Dec18.180027.23783@cbfsb.att.com>  
Date: 18 Dec 91 18:00:27 GMT  
Sender: news@cbfsb.att.com  
Organization: AT&T Bell Laboratories  
Lines: 51

copied from packet:

| Msg# | TSF | Size | #Rd | Date   | Time | From  | MsgID        | To             |
|------|-----|------|-----|--------|------|-------|--------------|----------------|
| 315  | BF  | 2122 | 0   | 13-Dec | 0449 | KD2EJ | 28988_WB2QJA | INFO@ALLBBS () |

Sb: TS-820 CW FILTER CONTROL

PERMISSION GRANTED FOR RELAYING AS INDICATED ON KENWOOD BBS.

SB-812

TS-520, TS-820 CW filter select control

2-14-80

In the TS-520SE, the heater switch has been replaced with a CW WIDE/NARROW select switch. For those operators who desire this type feature for their transceiver, the following information may be considered as a guideline.

TS-520S series transceivers

1. A miniature SPDT switch may be installed at the operators preference, on the rear side, or bottom panel. Use this to switch the CW or SSB filters by wiring the BROWN lead, which normally is transferred to the CW terminal on the IF unit, between the SSB filter, for WIDE , and CW for NARROW>
2. A Traditional solution has been to use the FIX CH switch, position 3 and 4 for filter switching. This may be done by completely rewiring the switch, or by leaving the switch wiring and the filter wiring as for normal operation, and bridging the following terminals:

- A. FIX CH C terminal to IF SSB Terminal
- B. FIX CH 4 terminal to IF CW terminal

Placing the FIX CH switch to 4 will operate the SSB filter in CW mode.

#### TS-820S Series Transceivers

1. Similar to the TS-520 series, a miniature SPDT toggle switch may be installed at the operators preference a the rear or on the obttom cover.
2. The FIX CH switch, or Digital Hold switch may be rewired to control the CW wide/narrow function

On the MODE switch, S6-1, the SSB filter control is GREEN, and the CW filter control line is GREY. Break the GREY line and connect it from the MODE switch to the SPDT common terminal. Connect the GREY line to the IF unit ot one terminal, and bridge tht GREEN SSB line to the other Switch terminal.

JEB/yn  
(c) 21480TKC

-----  
Note: I haven't tried or verified this, proceed at your own risk. WA2ISE

From: wa2ise@cbnewsb.cb.att.com (robert.f.casey)  
Newsgroups: rec.radio.amateur.misc  
#Subject: TS820 service notes  
Keywords: troubleshoot  
Message-ID: <1991Nov24.170603.29709@cbfsb.att.com>  
Date: 24 Nov 91 17:06:03 GMT  
Sender: news@cbfsb.att.com  
Organization: AT&T Bell Laboratories  
Lines: 175

copied from packet:

| Msg# | TSF | Size | #Rd | Date   | Time | From  | MsgID        | To            |
|------|-----|------|-----|--------|------|-------|--------------|---------------|
| 8167 | BF  | 5681 | 0   | 24-Nov | 0201 | KD2EJ | 27231_WB2QJA | ALL@ALLBBS () |

General Notes on TS-820S 10-25-77

1. No output TX: SG switch is "OFF".
2. No TX, RX or VFO: There is no 9 Pin plug installed.
3. Low RX Sensitivity, no TX: The transverter switch is "ON."
4. S Meter full deflection when first turned on: Makesure RF gain is not fully CCW.
5. If digital display does not count: Make sure DH is not "ON."
6. If there is no DG display: Make sure you are not in REMOTE VFO with no remote VFO attached.
7. When intermittant in any circuit:

- a. Check for loose black jumper from point to point on circuit board.
- b. Check for broken foil path.
- c. Check for component that has been pulled out or loosely soldered.
- d. Check for solder splash across foil path.
- e. Check for loose pins.
- f. Check for component leads touching to metal IF cans.
- g. Check for wire not soldered at function switch or at any switch or control.
- h. When checking FET's, check for excessive voltage at can top usually source, or same G-1, G-2 voltage.
- i. Check for loose Molex mini connector or any foreign substance on pins.

8. Complaint of frequency shift when TX-CW: This is normal. 800 Hz.

9. Not proper PLL action: Make sure PLL slide switch is in NOR not TUNE.

10. Receiver audio self oscillation at high level: Make sure audio board mounting screws are tight.

#### RECEIVER

- 1. Low audio output receiver sensitivity and no transmit: -6v supply is bad. Q13 on FIX VOX unit.
- 2. 25 kHz calibrator will not zero: Add 3 pf in parallel with TC-1 on the marker unit.
- 3. Receiver sensitivity down: Q2 on RF unit. +9v on PD unit is shorted. L-6 shorted to ground.
- 4. Intermittant receive when moving set.: Check for touching terminals at final relay socket.
- 5. No receiver or digital: 14v wire pinched between DG-1 chassis and ground.
- 6. Receiver sensitivity 40 db down: Check for shorted L8, 1.8 MHz antenna coil on coil pack.
- 7. Adjacent signal interference: See TKC bulletin.
- 8. No receive audio: Check for shorted TA-7201P module at X49-1080-00.
- 9. Poor receive audio: The 100 V AC 120 V taps were miswired.
- 10. Receiver doesn't work 20-40: Check for wafer touch to ground on band switch.
- 11. No DG1, no RX, no TX, no VCO: Bad D1 5 volt zener on relay unit.

12. RIT action seems warbly: See TKC bulletin.
13. Receiver has bad static and is noisy: Bad C14, C15, tantalum on PD unit.
14. VFO frequency shift: Check for loose tension of VFO tension spring.
15. USB/LSB will not work: Check for loose connection at C18 CAR-1 unit.
16. Intermittant audio: Check for loose mounting screws on audio board.

#### TRANSMITTER

1. Mushy audio on transmit: Mic amps Q20 and Q21 on IF unit are bad.
2. No 14V supply: Bad bridge diodes D8-D10 on X43-1090- 02.
3. Intermittant operation of any one band: Check for loosely soldered Xtals in PD unit.
4. Mic gain down: Cold solder joint at SSB xtal filter IF unit.
5. Self oscillation when TX: Bad final tubes. Burned cathode resistors 10 ohms R2, R3 at final unit.
6. No VOX operation. No sidetone: Burned resistor R12 220 ohms at key socket.
7. No USB or LSB: Check CAR1 X1-X2 crystal for cold solder joint on CAR-1 unit.
8. No TX: Check for shorted Q1 and Q8 balanced mixer on RF Unit.
9. No ALC meter movement: Readjustment of meter amp VR1, VR2 on IF unit.
10. Intermittant ALC action after peaking drive: One final tube is bad.
11. Fix lite on when in VFO position: Wire shorted terminals on function switch.
12. No loading of TX: Cold solder joint at relay socket RL1 antenna relay.
13. Using Sure 444 speech processor is distorted: See TKC bulletin regarding 16db pad for mic input.
14. No relay closure on TX: Q9 on fix Vox unit is bad.
15. Very low RF output only when using RF speech processor: Bad Q30 on IF unit.
16. Low RF output on SSB without RF speech processor: Bad Q20 on X48-1150-00.

17. Large audio difference between USB and LSB: realign carrier unit per TKC specifications.
18. No loading on 40 meters: Foil path is open on RF coil pack.
19. No TX when using send switch: Bad R28 1K and Q9 on FIX VOX unit.
20. Blows fuse: Check for shorted C21, C22 100uf 500v.
21. No drive, no TX or bias: Open screen resistor R6 470 ohm at rectifier unit.
22. VFO intermittent: Check for cold solder at VFO power plug.
23. Audio distortion on TX with processor: C96 may be loose on IF board.
24. Faulty LED indications: Check for loose ground screws on LED board.
25. Low output on CW: R14 470 Ohm touch to filter case on IF unit.
26. VOX operation is intermittent: Solder touch VS terminal and 14v at X50-11350-00).
27. Intermittent TX: Make sure ground strap for 12BY7 shield is under the shield.
28. Insufficient power out to drive linear amplifier: An increase of 5-7 watts can
29. VFO output level is down: Q2 inside VFO is bad.
30. No TX or RX on any band. No VCO output: Q14 on X50-1330-00 is bad.
31. No TX or RX: Loose contact VFO output terminal on Fix Vox unit.

(c) 102577TKC

Copyrighted Kenwood U.S.A. Corp.

Relayed by KD2EJ with permission from Kenwood U.S.A.

-----  
Note: I haven't tried or verified this, proceed at your own risk. WA2ISE

From: wa2ise@cbnewsb.cb.att.com (robert.f.casey)  
Newsgroups: rec.radio.amateur.misc  
#Subject: TS820 speech processor alignment procedure  
Keywords: ts820  
Message-ID: <1991Dec1.030349.25950@cbfsb.att.com>  
Date: 1 Dec 91 03:03:49 GMT  
Sender: news@cbfsb.att.com  
Organization: AT&T Bell Laboratories  
Lines: 53

copied from packet, from kd2ej:  
SB-009





From: wa2ise@cbnewsb.cb.att.com (robert.f.casey)  
Newsgroups: rec.radio.amateur.misc  
Subject: TS830 frequency shift, low volt fix  
Keywords: ts830  
Message-ID: <1991Dec18.183055.25404@cbfsb.att.com>  
Date: 18 Dec 91 18:30:55 GMT  
Sender: news@cbfsb.att.com  
Organization: AT&T Bell Laboratories  
Lines: 90

this is a series of articles on the TS830 copied from packet:

| Msg# | TSF | Size | #Rd | Date   | Time | From  | MsgID        | To             |
|------|-----|------|-----|--------|------|-------|--------------|----------------|
| 375  | BF  | 1860 | 0   | 15-Dec | 1654 | KD2EJ | 29224_WB2QJA | INFO@ALLBBS () |

Sb: TS-830 FREQ. SHIFT

PERMISSION GRANTED FOR RELAYING AS INDICATED ON KENWOOD BBS.

SB-840R

TS-830S Frequency Shift

04-14-82

Some users may report an intermittent shift in the display and operating frequency. This may typically be a 1 to 4 kHz random shift. Cause will be a loose grounding screw on the AF/AVR unit heat sink.

On the AF/AVR unit X49-1140-00, there are three self-tapping screws holding the aluminum heat sink to the PCB. These also supply the ground connection to that section of the board. Between the heat sink and PCB foil, add a tooth-lockwasher N17-1030-41 at eht two self-tapping screws on the side of the heatsink that has the two transistors attached. (The remaining screw already has a lock washer.) When replacing the board to the chassis, add a solder lug E23-0420-05 to the heat sink mounting screw as shown, and tighten all screws for this board. Solder an insulated lead between the TPG (Test Point Ground) wrap post adjacent to C81, and the added solder lug.

Procedure:

1. Remove the top cover (8 screws) and unplug the speaker.
2. Remove the bottom cover (8 screws).
3. Remove 5 screws holding the AF/AVR unit and swing the board over. Leads do not have to be unplugged.
4. Add two tooth-lock washer as shown.
5. Replace the circuit board and heat sink to the chassis, adding the solder lug as shown.
6. Solder a jumper between the TPG wrap post and the added solder lug.
7. Replace the top and bottom covers.

Installation time for this procedure is 1/2 hour or less.



JEB/yn  
(c) 41482TKC

Msg# TSF Size #Rd Date Time From MsgID To  
376 BF 1226 0 15-Dec 1659 KD2EJ 29225\_WB2QJA INFO@ALLBBS ()  
Sb: TS-830 LOW VOLT. SUPPLY NOTE.

PERMISSION GRANTED FOR RELAYING AS INDICATED ON KENWOOD BBS.

SB-847R

TS-830S Low Voltage Supply Optional Improvements 7-29-81

Power supply drift and stability may be improved by these optional component changes and additions.

On the AF AVR unit X49-1140-00 (Vicinity of Q27-Q30) change:

R124 from 1K to 1.5K (RD14CB2E152J)\*  
R127 from 470 to 390 (RD14CB2E391J)\*  
R130 from 47K to 33K (RD14CB2E333J)#  
D25 from WZ-061 to XZ-053 (V11-4101-60)\*

\*This will improve temperature drift from a maximum of about 100mV to a maximum of 1mV, and may be applied to any unit before serial # 201xxxx.

Add two 22 k ohm 1/4 resistors (RD14CB2E223J0, one each across Q30, and Q34, collector to emitter.#

#This will improve overall stability and may be applied to any unit before serial #105xxxx.

Note: These changes are at the owners option and may not be performed in-warranty.

JEB/sh  
(c) 041482TKC

=====  
Note: I haven't tried or verified this, proceed at your own risk. WA2ISE



Path: njitgw.njit.edu!dorm.rutgers.edu!rutgers!ub!zaphod.mps.ohio-state.edu!  
uwm.edu!linac!att!cbfsb!cbnewsb.cb.att.com!wa2ise  
From: wa2ise@cbnewsb.cb.att.com (robert.f.casey)  
Newsgroups: rec.radio.amateur.misc  
Subject: TS850S features and mod file (long)  
Keywords: features, mods  
Message-ID: <1991Oct26.033601.11100@cbfsb.att.com>  
Date: 26 Oct 91 03:36:01 GMT  
Sender: news@cbfsb.att.com  
Organization: AT&T Bell Laboratories  
Lines: 291

copied from packet:

This was a 4 article set that I merged into one long article. Talks about various features and mods for this radio  
begin article:

From: ka2raf@nn2z.nj.usa.na  
To: 850mod@allbbs  
#Subject: TS850S mods 1

Having lived with Kenwood's TS-850S transceiver for 5 days, here are some of my observations:

- . While the manual shows 35 power-on front panel adjustments, there really are 36. Function number 35 is set from the factory to the OFF state. Well, what exactly is this unknown function? Well Bunkies, this enables the transceiver to transmit on 27.500 through 28.000 mhz! Do yourself a favor, and set this option to ON for TX inhibit! DO NOT JEAPORDIZE YOUR LICENSE! Why in the world did the factory allow this??? Maybe they don't want the Chicken Banders butchering up the rigs....
- . Tone control. The setup only allows Burst or Continuous modes, there is no way to turn it OFF, even though the manual indicates there is a way.
- . Quick memory function. You MUST pass through either the VFO A or VFO B registers to program these.. You cannot go from standard memory to quick memory directly.
- . My 850S came out of the box running low power (50 - 75w PEP), so I called the local ham radio dealer inquiring about service manual availability. Well they had them in stock, but at a price of \$50.00! Unbelievable! Kenwood wants fifty dollars for (in the continuing Kenwood tradition) a terribly organized, incomplete, and horrible reading manual!!! Well, I dug into the schematics and opened up the the radio, here's a list of items that might be of interest to some:

#### RF Board Controls

-----  
VR - RX BAL  
VR - TX BIAS  
VR - TX BAL

VR - TYP (50W output power adjust, used with S1 below)  
VR - MIN (?????) / internal antenna tuner  
VR - TUN (Tune mode power adjust)  
VR - VSF (THIS IS THE 100W POWER OUTPUT CONTROL)  
VR - SWR Protect activation  
VR - PWM (Forward power meter calibration)  
VR1 - RWM (Reflected power meter calibration)  
VR1 - AL0 (ALC meter zero)  
VR1 - ALM (ALC meter calibration)  
VR1 - CPM (Processor meter calibration)  
VR1 - ALG (ALC gain adjustment)

S - All Band Power Down Switch (Decreases power to 50 watts)

#### IF Board Controls

-----  
VR -  
VR -  
VR -  
VR - Beep volume  
VR - Sidetone volume  
VR - Processor adjust  
VR - ?????  
VR8 & VR9 - ?????  
VR1 - ?????  
VR1 -  
VR12 & VR13 - S Meter adjust  
VR14 & VR15 - AGC adjust  
VR1 - Notch filter adjust

- . PLEASE NOTE!  
Most of these controls are 1/8" pots, so if you intend to adjust them use a VERY SMALL non-metallic tool.
- . My 850S also came out of the box with the RIT/XIT control not displaying 0.00 khz at fiducial (12 o'clock position) center. Behind the front panel in the upper right corner is the control for center adjust. It just needed a wee bit of tweaking... Along with this control on the circuit board are the master adjustments for the SSB slope tuning (High Cut and Low Cut).
- . When both top and bottom covers are removed, on the left-hand side is the FM board. There are 3 (three) pots on the board. They are FM Wide (12khz) deviation, FM Narrow (6khz) deviation, and FM Mic gain.

Author's note: I cannot say whether ALL the information above is accurate. I do not purport to be an electronics wizard, but am just an Amateur radio operator who wants to get the most enjoyment out of his equipment

Let's beat the ridiculous cost of poorly written service manuals! Add to this document and please circulate it!

73,  
Jan - KC2CT

#Subject: TS850S mods 2

More Observations As Of 6-26-91 - KC2CT  
-----

- . FM mode defaults to WIDE (12khz). This is WAY too wide for accessing any 10m repeater. Hit the 455khz filter button again for FM-N (narrow). This will set the IF to 6khz width, and you be able to work FM 10m stations. Note: The 8.83 filters are NOT selectable in FM mode.
- . Memory scrolling via M CH./VFO CH. You can bypass all unused channels if you press the 1 mhz button. With the button active, only stored memory channels will be displayed as the knob is rotated.
- . Tuneable memories. Out of the box, the radio is set up for non-tuneable memories. Just bring up setup function xx on the display, and set it to ON, and ALL memories can be tuned via the VFO. When use the M.CH/VFO CH. switch you will be returned to the original frequency & mode setting in the memory.
- . It may or may not be obvious to some, but the radio is capable of cross-band and/or cross-mode operation. Just pump the required modes and frequencies into memory channels or VFOs, and you're off and running. Hope you have a very broadbanded antenna!
- . CW message storage is lost when you power off the radio. I didn't order the DRU-2 option (yet), so I don't know whether these messages will be saved. You'd think that with everything else that is stored in RAM and backed up by battery, that Kenwood would have made provisions to keep recorded messages alive also. A modification????
- . When adding additional filters, is is necessary to set the corresponding switch on. Under the hatch on top, is a 4 position dip switch. The manual shows a picture of it, but makes no mention of their settings. This switch is necessary to inform the micro-processor of the filters' absence or presence. ON is for presence, OFF is for absence. Below is the switch diagram:

```
-----  
| = | <-- YK-88C-1, YK-88CN-1, YK-88SN-1  
| = | <-- YK-88CN-1, YK-88CN-1, YK-88SN-1  
| = | <-- No Function  
| = | <-- YG-455C-1 or YG-455CN-1  
-----  
O   O  
N   F  
    F
```

#Subject: TS850S mods 3

More Observations As Of 6-30-91 - KC2CT  
-----

Well here I am again with more stuff on the 850S...

- . I received the DRU-2, voice recording unit this week, and installed it. Here's what I found:
- . The unit comes with a lithium battery for backing up the voice messages when the rig is powered off.
- . The initial state of the DRU-2 is:  
  
Message 1 - 8 seconds  
Message 2 - 8 seconds  
Message 3 - 16 seconds  
  
You can halve the sampling rate via front panel setup control xx. This will effectively DOUBLE the time of each message, however, the quality of voice reproduction will suffer because of the lower sampling rate.
- . On playback of the messages, the microphone IS NOT disabled, so be quiet when you're transmitting stored messages.
- . Use the MONI function to hear what you've recorded and/or are transmitting, and the MIC gain control to keep the ALC in range, as the DRU-2 drives the radio much harder than the microphone input.
- . The high boost function and speech processor are available to the DRU-2 during transmit.
- . I also got the VS-2 voice unit. The voice is the same as the older VS-1 for the TS-440, and TS-940, but the unit is in a smaller package. It will speak the frequency in either English or Japanese. There is a volume control pot on the bottom of the board which should be adjusted PRIOR to screwing down the VS-2. The output on my unit was very low, until I tweaked it up. Also there are jumpers on the board to speed up the voice playback... You'll need to consult the instruction page for the VS-1 for speeds, as there is nothing mentioned in the instructions for the VS-2.
- . A note on output power of the rig. The radio uses 2SC2789's... These devices are rated as 100 watt devices Kenwood is running the finals VERY conservatively. When playing around with output, I had the rig dead-keying 175 watts, but backed it down to 100 watts, as I didn't want to blow up the rig, but I was definitely smiling as the Birds' meter swung with a 250 watt slug!
- . The ROM chip on the digital board is socketed. Kenwood had problems with early 440's and 940's with poor soldered connections. While it's a nice idea to allow removal and replacement of the ROM to add features/fix bugs, this might become a problem area in the future.
- . Hidden function!!! If you turn on the radio while holding down the VOICE button, EVERY button on the radio will acknowledge its

function via morse code! This is a terrific feature for sightless hams! I can't understand why it is not mentioned in the owners manual or marketing literature!

#Subject: TS850S mods 4

Still MORE Observations - KC2CT - 07-05-91  
-----

Well if you've been following this brief series, you probably know by now, that despite any criticism, I really LOVE my 850S! I've really dug into the guts of the radio, and truly find it a pleasure to explore and operate..Well here's a few other items that should be of interest to other hams:

. ALL BAND TRANSMIT  
-----

Kenwood markets this radio worldwide, and has made provisions to allow the radio to transmit between 1.625 mhz and 29.999 mhz. I am providing this modification for INFORMATIONAL PURPOSES ONLY! DO NOT TRANSMIT OUT OF BAND, THIS WILL JEAPORDIZE YOUR LICENSE, AND HAVE THE FCC, AND/OR INTERNATIONAL AUTHORITIES KNOCKING AT YOUR DOOR!!!

The All-band transmit modification requires the removal and re-location of a diode on the the digital board which is located behind the front panel. The US version of the radio has diode D11 installed, and diode D9 removed. D11 must be removed, and installed in the D9 position. This modification IS NOT for the faint of heart, as it entails removing the front panel, and the digital board. Note that the digital board has solder holes that are through-soldered; that is, there are circuit traces on both sides of the board, so make sure that ALL solder is removed from the holes. This modification will also allow the antenna tuner to tune anywhere the receiver is tuned. This modification should ONLY be performed by those familiar with soldering and de-soldering techniques, and requires patience, and dexterity.

. Broadcast Band Sensitivity  
-----

BCB sensitivity REALLY suffers as a 24db attenuator is inserted when band-switched. This attenuator circuit is very similiar to the TS-430/440. Possible modification?

. Additional Front Panel Functions  
-----

Pressing SCAN + TX-M.CH will set the radio into its extended function mode. These options can be scrolled via the M.CH/VFO CH. switch. The following are the extended functions:

- 00 - This is the ROM Checksum displayed as a 4-digit hexadecimal number This cannot be changed.
- 01 - Allow filter selection in transmit. Initially set OFF.
- 02 - Antenna tuner power down. Initially set to OFF.

- 03 - Antenna tuner non-stop mode. When set to on, the antenna tuner will not stop when the lowest VSWR is found. Initially set to OFF.
- 04 - Store mode, and filter settings prior to changing bands, or channels. Initially set to ON.
- 05 - Display -HELLO- on digital display, and send it in Morse code on power up. Initially set OFF.
- 06 - Turn full LCD display ON on power on. Initially set OFF.
- 07 - Turn Subtone ON or OFF. Initially set ON. Note that even when set off, the TONE indicator will be lit on the display.
- 08 - Unknown. Initially set OFF.

---

Note: I haven't tried or verified any of this, proceed at your own risk. And do not transmit outside of legal bands. WA2ISE





Path: njitgw.njit.edu!dorm.rutgers.edu!rutgers!ub!zaphod.mps.ohio-state.edu!  
uakari.primate.wisc.edu!aplcn!wb3ffv!ka3ovk!ka3pgn  
From: ka3pgn@ka3ovk (Dave Norment)  
Newsgroups: rec.radio.amateur.misc  
Subject: Re: TS850S features and mod file (long)  
Keywords: features, mods  
Message-ID: <1991Oct27.110247.18517@ka3ovk>  
Date: 27 Oct 91 11:02:47 GMT  
References: <1991Oct26.033601.11100@cbfsb.att.com>  
Organization: Internal Revenue Service, Washington, DC  
Lines: 150

I really appreciated your remarks about the 850. I've owned mine for about four months now and one of the first things I did was to disable the broadcast band attenuation. Being an avid BCB DX'er, I found this little device quite an annoyance! So, the first day out of the box, I did away with it and very easily at that.

HERE ARE THE STEP BY STEP INSTRUCTIONS TO DISABLE THE BROADCAST BAND ATTENUATION FOR THE KENWOOD TS-850S. This mod greatly improves the sensitivity and likewise the reception on the AM broadcast band. No noticable unwanted side effects have occurred following this procedure. I live within three miles of a 5,000 watt broadcast station on 1150 kc's and am able to listen to stations on either side of that station. There is some splatter but using the notch filter and the attenuation on the front of the radio takes care of that for the most part. This is \*NOT\* complicated and can be done in fifteen minutes. Only one caution here: you WILL BE SOLDERING TWO POINTS ON A CIRCUIT BOARD THAT IS LOADED WITH SURFACE MOUNTED COMPONENTS!!! There is little room to work on the board, so be very careful with your iron! If you don't feel comfortable soldering, get someone else to do it as you can cause a solder bridge and ruin your radio without even trying. With that in mind, here goes:

- 1) remove the eleven screws that secure the bottom cover to the rig. the six ones on the sides and the five on the bottom cover itself.
- 2) remove the bottom cover. there are no wires attached to the cover. lift it right off. leave the top cover of the radio ON.
- 3) locate the RF BOARD. it's number is: X44-3120-00. this is the board where you plug the optional filters into. with the open radio in front of you, and the front of the radio facing you, the RF BOARD is the one on the left. (there are only two boards under the bottom cover)
- 4) locate the chrome like shield on the rear of the RF BOARD. it's made out of shiny steel. remove the four screws that hold this shield to the board.
- 5) remove the shield by lifting the front of it up while sliding it forwards, towards you. watch out for all the little wires and ribbon cables going to and from the RF BOARD.
- 6) look at the rear of the board and towards the left corner. (the radio is still facing you upside down) notice two I/C's numbered IC1 and IC2. directly behind the I/C's are a bank of adjustable coils in metal cans. there are nine of these coils in a group. directly to the left of these coils are many green and red inductors which are standing up. they look like resistors but they're really small coils.
- 7) these inductors are part of the bandpass filtering for each of the bands on the radio. the capacitors and resistors that complete the bandpass

filtering are on the other side of the board and are of the surface mount type. you are only concerned with the bandpass filter for the .5 to 1.6 band. notice the numbers for the inductors. find L8 and L9. they are right at the edge of the board in the left rear corner you will notice that .5 - 1.6 is stamped right next to L9.

BINGO! you have found the part of the circuit that you will modify.

- 8) look at where the .5 - 1.6 is stamped on the board next to L9. you will see two bronze or gold solder points there directly next to the numbers .5 - 1.6 . there is nothing soldered at those two points. this is where you will solder a jumper wire between the bronze points. do NOT confuse it with the other two solder points with the line running in between them next to the phillips head screw!!! you want the two points that are spaced very close together that is right next to L9.
- 9) you will have to do the soldering on the OTHER SIDE OF THE BOARD. remove the nine phillips head screws that hold the RF BOARD to the chassis.
- 10) on the back of the radio, look for the switch stamped SW 1. it's right below the grounding post and has the two postions: INT and EXT. remove the two screws that hold the switch to the back of the rig. the switch is soldered to the RF BOARD and you wont be able to lift the board up until the screws are removed.
- 11) unplug enough cables from the board so you'll have enough room to lift the RF BOARD up to solder the jumper. there is no need to remove the board from the rig. slide it towards the front of the rig until the switch SW 1 clears the back of the rig and lift the left side of the board up and prop it up with a small block of wood.
- 12) locate the bronze solder points on the underside of the board. there will be a small amount of solder at these two points on the underside of the board.
- 13) bend a small jumper out of wire that fits the two bronze points on top of the RF BOARD. you will place the jumper on the top and solder on the underside of the board. with a pair of needle nosed pliers, place the jumper into the holes and simply heat up the existing solder on the underside until the jumper slips down farther into the holes. you'll notice the large amount of components on the underside versus the lack of components on the top of the board. be carefull when heating the solder on the two points. you don'y want to disturb the surface mounted parts or cause any excess solder to run onto them or the foil nearby.
- 14) you are now done. re-assemble in reverse order, plugging the wires back in carefully, making sure they don't get plugged into the wrong place. also, avoid pinching them when replacing covers.

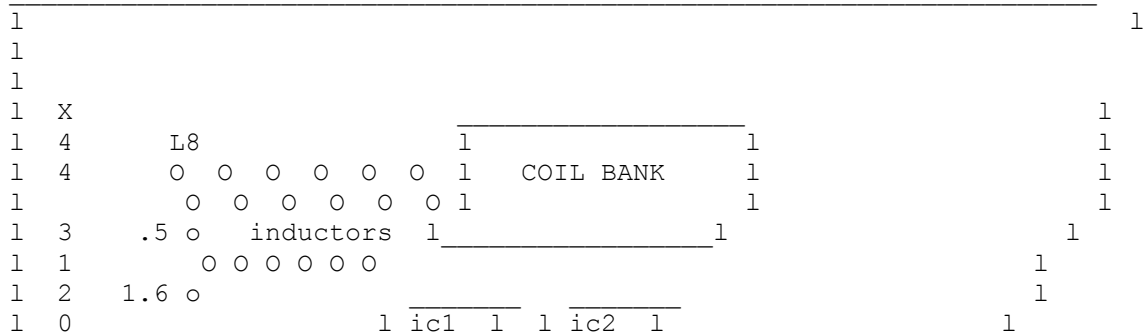





From: wa2ise@cbnewsb.cb.att.com (robert.f.casey)  
Newsgroups: rec.radio.amateur.misc  
Subject: TS850S features and mod file (long)  
Keywords: features, mods  
Message-ID: <1991Oct26.033601.11100@cbfsb.att.com>  
Date: 26 Oct 91 03:36:01 GMT  
Sender: news@cbfsb.att.com  
Organization: AT&T Bell Laboratories  
Lines: 291

copied from packet:

This was a 4 article set that I merged into one long article. Talks about various features and mods for this radio  
begin article:

From: ka2raf@nn2z.nj.usa.na  
To: 850mod@allbbs  
#Subject: TS850S mods 1

Having lived with Kenwood's TS-850S transceiver for 5 days, here are some of my observations:

- . While the manual shows 35 power-on front panel adjustments, there really are 36. Function number 35 is set from the factory to the OFF state. Well, what exactly is this unknown function? Well Bunkies, this enables the transceiver to transmit on 27.500 through 28.000 mhz! Do yourself a favor, and set this option to ON for TX inhibit! DO NOT JEAPORDIZE YOUR LICENSE! Why in the world did the factory allow this??? Maybe they don't want the Chicken Banders butchering up the rigs....
- . Tone control. The setup only allows Burst or Continuous modes, there is no way to turn it OFF, even though the manual indicates there is a way.
- . Quick memory function. You MUST pass through either the VFO A or VFO B registers to program these.. You cannot go from standard memory to quick memory directly.
- . My 850S came out of the box running low power (50 - 75w PEP), so I called the local ham radio dealer inquiring about service manual availability. Well they had them in stock, but at a price of \$50.00! Unbelievable! Kenwood wants fifty dollars for (in the continuing Kenwood tradition) a terribly organized, incomplete, and horrible reading manual!!! Well, I dug into the schematics and opened up the the radio, here's a list of items that might be of interest to some:

#### RF Board Controls

-----  
VR - RX BAL  
VR - TX BIAS  
VR - TX BAL  
VR - TYP (50W output power adjust, used with S1 below)  
VR - MIN (?????) / internal antenna tuner

VR - TUN (Tune mode power adjust)  
VR - VSF (THIS IS THE 100W POWER OUTPUT CONTROL)  
VR - SWR Protect activation  
VR - PWM (Forward power meter calibration)  
VR1 - RWM (Reflected power meter calibration)  
VR1 - AL0 (ALC meter zero)  
VR1 - ALM (ALC meter calibration)  
VR1 - CPM (Processor meter calibration)  
VR1 - ALG (ALC gain adjustment)

S - All Band Power Down Switch (Decreases power to 50 watts)

#### IF Board Controls

-----  
VR -  
VR -  
VR -  
VR - Beep volume  
VR - Sidetone volume  
VR - Processor adjust  
VR - ??????  
VR8 & VR9 - ??????  
VR1 - ??????  
VR1 -  
VR12 & VR13 - S Meter adjust  
VR14 & VR15 - AGC adjust  
VR1 - Notch filter adjust

. PLEASE NOTE!

Most of these controls are 1/8" pots, so if you intend to adjust them use a VERY SMALL non-metallic tool.

- . My 850S also came out of the box with the RIT/XIT control not displaying 0.00 khz at fiducial (12 o'clock position) center. Behind the front panel in the upper right corner is the control for center adjust. It just needed a wee bit of tweaking... Along with this control on the circuit board are the master adjustments for the SSB slope tuning (High Cut and Low Cut).
- . When both top and bottom covers are removed, on the left-hand side is the FM board. There are 3 (three) pots on the board. They are FM Wide (12khz) deviation, FM Narrow (6khz) deviation, and FM Mic gain.

Author's note: I cannot say whether ALL the information above is accurate. I do not purport to be an electronics wizard, but am just an Amateur radio operator who wants to get the most enjoyment out of his equipment

Let's beat the ridiculous cost of poorly written service manuals! Add to this document and please circulate it!

73,  
Jan - KC2CT

#Subject: TS850S mods 2

More Observations As Of 6-26-91 - KC2CT

- 
- . FM mode defaults to WIDE (12khz). This is WAY too wide for accessing any 10m repeater. Hit the 455khz filter button again for FM-N (narrow). This will set the IF to 6khz width, and you be able to work FM 10m stations. Note: The 8.83 filters are NOT selectable in FM mode.
  - . Memory scrolling via M CH./VFO CH. You can bypass all unused channels if you press the 1 mhz button. With the button active, only stored memory channels will be displayed as the knob is rotated.
  - . Tuneable memories. Out of the box, the radio is set up for non-tuneable memories. Just bring up setup function xx on the display, and set it to ON, and ALL memories can be tuned via the VFO. When use the M.CH/VFO CH. switch you will be returned to the original frequency & mode setting in the memory.
  - . It may or may not be obvious to some, but the radio is capable of cross-band and/or cross-mode operation. Just pump the required modes and frequencies into memory channels or VFOs, and you're off and running. Hope you have a very broadbanded antenna!
  - . CW message storage is lost when you power off the radio. I didn't order the DRU-2 option (yet), so I don't know whether these messages will be saved. You'd think that with everything else that is stored in RAM and backed up by battery, that Kenwood would have made provisions to keep recorded messages alive also. A modification????
  - . When adding additional filters, is is necessary to set the corresponding switch on. Under the hatch on top, is a 4 position dip switch. The manual shows a picture of it, but makes no mention of their settings. This switch is necessary to inform the micro-processor of the filters' absence or presence. ON is for presence, OFF is for absence. Below is the switch diagram:

```
-----
| = | <-- YK-88C-1, YK-88CN-1, YK-88SN-1
| = | <-- YK-88CN-1, YK-88CN-1, YK-88SN-1
| = | <-- No Function
| = | <-- YG-455C-1 or YG-455CN-1
-----
O   O
N   F
    F
```

#Subject: TS850S mods 3

More Observations As Of 6-30-91 - KC2CT

-----

Well here I am again with more stuff on the 850S...



. I received the DRU-2, voice recording unit this week, and installed it. Here's what I found:

. The unit comes with a lithium battery for backing up the voice messages when the rig is powered off.

. The initial state of the DRU-2 is:

Message 1 - 8 seconds

Message 2 - 8 seconds

Message 3 - 16 seconds

You can halve the sampling rate via front panel setup control xx. This will effectively DOUBLE the time of each message, however, the quality of voice reproduction will suffer because of the lower sampling rate.

. On playback of the messages, the microphone IS NOT disabled, so be quiet when you're transmitting stored messages.

. Use the MONI function to hear what you've recorded and/or are transmitting, and the MIC gain control to keep the ALC in range, as the DRU-2 drives the radio much harder than the microphone input.

. The high boost function and speech processor are available to the DRU-2 during transmit.

. I also got the VS-2 voice unit. The voice is the same as the older VS-1 for the TS-440, and TS-940, but the unit is in a smaller package. It will speak the frequency in either English or Japanese. There is a volume control pot on the bottom of the board which should be adjusted PRIOR to screwing down the VS-2. The output on my unit was very low, until I tweaked it up. Also there are jumpers on the board to speed up the voice playback... You'll need to consult the instruction page for the VS-1 for speeds, as there is nothing mentioned in the instructions for the VS-2.

. A note on output power of the rig. The radio uses 2SC2789's... These devices are rated as 100 watt devices Kenwood is running the finals VERY conservatively. When playing around with output, I had the rig dead-keying 175 watts, but backed it down to 100 watts, as I didn't want to blow up the rig, but I was definitely smiling as the Birds' meter swung with a 250 watt slug!

. The ROM chip on the digital board is socketed. Kenwood had problems with early 440's and 940's with poor soldered connections. While it's a nice idea to allow removal and replacement of the ROM to add features/fix bugs, this might become a problem area in the future.

. Hidden function!!! If you turn on the radio while holding down the VOICE button, EVERY button on the radio will acknowledge its function via morse code! This is a terrific feature for sightless hams! I can't understand why it is not mentioned in the owners

manual or marketing literature!

#Subject: TS850S mods 4

Still MORE Observations - KC2CT - 07-05-91  
-----

Well if you've been following this brief series, you probably know by now, that despite any criticism, I really LOVE my 850S! I've really dug into the guts of the radio, and truly find it a pleasure to explore and operate..Well here's a few other items that should be of interest to other hams:

. ALL BAND TRANSMIT  
-----

Kenwood markets this radio worldwide, and has made provisions to allow the radio to transmit between 1.625 mhz and 29.999 mhz. I am providing this modification for INFORMATIONAL PURPOSES ONLY! DO NOT TRANSMIT OUT OF BAND, THIS WILL JEAPORDIZE YOUR LICENSE, AND HAVE THE FCC, AND/OR INTERNATIONAL AUTHORITIES KNOCKING AT YOUR DOOR!!!

The All-band transmit modification requires the removal and re-location of a diode on the the digital board which is located behind the front panel. The US version of the radio has diode D11 installed, and diode D9 removed. D11 must be removed, and installed in the D9 position. This modification IS NOT for the faint of heart, as it entails removing the front panel, and the digital board. Note that the digital board has solder holes that are through-soldered; that is, there are circuit traces on both sides of the board, so make sure that ALL solder is removed from the holes. This modification will also allow the antenna tuner to tune anywhere the receiver is tuned. This modification should ONLY be performed by those familiar with soldering and de-soldering techniques, and requires patience, and dexterity.

. Broadcast Band Sensitivity  
-----

BCB sensitivity REALLY suffers as a 24db attenuator is inserted when band-switched. This attenuator circuit is very similiar to the TS-430/440. Possible modification?

. Additional Front Panel Functions  
-----

Pressing SCAN + TX-M.CH will set the radio into its extended function mode. These options can be scrolled via the M.CH/VFO CH. switch. The following are the extended functions:

- 00 - This is the ROM Checksum displayed as a 4-digit hexadecimal number This cannot be changed.
- 01 - Allow filter selection in transmit. Initially set OFF.
- 02 - Antenna tuner power down. Initially set to OFF.
- 03 - Antenna tuner non-stop mode. When set to on, the antenna tuner will not stop when the lowest VSWR is found. Initially

set to OFF.

- 04 - Store mode, and filter settings prior to changing bands, or channels. Initially set to ON.
- 05 - Display -HELLO- on digital display, and send it in Morse code on power up. Initially set OFF.
- 06 - Turn full LCD display ON on power on. Initially set OFF.
- 07 - Turn Subtone ON or OFF. Initially set ON. Note that even when set off, the TONE indicator will be lit on the display.
- 08 - Unknown. Initially set OFF.

---

Note: I haven't tried or verified any of this, proceed at your own risk. And do not transmit outside of legal bands. WA2ISE

From: ka3pgn@ka3ovk (Dave Norment)  
Newsgroups: rec.radio.amateur.misc  
#Subject: Re: TS850S features and mod file (long)  
Keywords: features, mods  
Message-ID: <1991Oct27.110247.18517@ka3ovk>  
Date: 27 Oct 91 11:02:47 GMT  
References: <1991Oct26.033601.11100@cbfsb.att.com>  
Organization: Internal Revenue Service, Washington, DC  
Lines: 150

I really appreciated your remarks about the 850. I've owned mine for about four months now and one of the first things I did was to disable the broadcast band attenuation. Being an avid BCB DX'er, I found this little device quite an annoyance! So, the first day out of the box, I did away with it and very easily at that.

HERE ARE THE STEP BY STEP INSTRUCTIONS TO DISABLE THE BROADCAST BAND ATTENUATION FOR THE KENWOOD TS-850S. This mod greatly improves the sensitivity and likewise the reception on the AM broadcast band. No noticeable unwanted side effects have occurred following this procedure. I live within three miles of a 5,000 watt broadcast station on 1150 kc's and am able to listen to stations on either side of that station. There is some splatter but using the notch filter and the attenuation on the front of the radio takes care of that for the most part. This is \*NOT\* complicated and can be done in fifteen minutes. Only one caution here: you WILL BE SOLDERING TWO POINTS ON A CIRCUIT BOARD THAT IS LOADED WITH SURFACE MOUNTED COMPONENTS!!! There is little room to work on the board, so be very careful with your iron! If you don't feel comfortable soldering, get someone else to do it as you can cause a solder bridge and ruin your radio without even trying. With that in mind, here goes:

- 1) remove the eleven screws that secure the bottom cover to the rig. the six ones on the sides and the five on the bottom cover itself.
- 2) remove the bottom cover. there are no wires attached to the cover. lift it right off. leave the top cover of the radio ON.
- 3) locate the RF BOARD. it's number is: X44-3120-00. this is the board

where you plug the optional filters into. with the open radio in front of you, and the front of the radio facing you, the RF BOARD is the one on the left. (there are only two boards under the bottom cover)

- 4) locate the chrome like shield on the rear of the RF BOARD. it's made out of shiny steel. remove the four screws that hold this shield to the board.
- 5) remove the shield by lifting the front of it up while sliding it forwards, towards you. watch out for all the little wires and ribbon cables going to and from the RF BOARD.
- 6) look at the rear of the board and towards the left corner. (the radio is still facing you upside down) notice two I/C's numbered IC1 and IC2. directly behind the I/C's are a bank of adjustable coils in metal cans. there are nine of these coils in a group. directly to the left of these coils are many green and red inductors which are standing up. they look like resistors but they're really small coils.
- 7) these inductors are part of the bandpass filtering for each of the bands on the radio. the capacitors and resistors that complete the bandpass filtering are on the other side of the board and are of the surface mount type. you are only concerned with the bandpass filter for the .5 to 1.6 band. notice the numbers for the inductors. find L8 and L9. they are right at the edge of the board in the left rear corner you will notice that .5 - 1.6 is stamped right next to L9. BINGO! you have found the part of the circuit that you will modify.
- 8) look at where the .5 - 1.6 is stamped on the board next to L9. you will see two bronze or gold solder points there directly next to the numbers .5 - 1.6 . there is nothing soldered at those two points. this is where you will solder a jumper wire between the bronze points. do NOT confuse it with the other two solder points with the line running in between them next to the phillips head screw!!! you want the two points that are spaced very close together that is right next to L9.
- 9) you will have to do the soldering on the OTHER SIDE OF THE BOARD. remove the nine phillips head screws that hold the RF BOARD to the chassis.
- 10) on the back of the radio, look for the switch stamped SW 1. it's right below the grounding post and has the two positions: INT and EXT. remove the two screws that hold the switch to the back of the rig. the switch is soldered to the RF BOARD and you won't be able to lift the board up until the screws are removed.
- 11) unplug enough cables from the board so you'll have enough room to lift the RF BOARD up to solder the jumper. there is no need to remove the board from the rig. slide it towards the front of the rig until the switch SW 1 clears the back of the rig and lift the left side of the board up and prop it up with a small block of wood.
- 12) locate the bronze solder points on the underside of the board. there will be a small amount of solder at these two points on the underside of the board.
- 13) bend a small jumper out of wire that fits the two bronze points on top of the RF BOARD. you will place the jumper on the top and solder on the underside of the board. with a pair of needle nosed pliers, place the jumper into the holes and simply heat up the existing solder on the underside until the jumper slips down farther into the holes. you'll notice the large amount of components on the underside versus the lack of components on the top of the board. be careful when heating the solder on the two points. you don't want to disturb the surface mounted parts or cause any excess solder to run onto them or the foil nearby.



Dave

--

```
| Dave Norment, United Broadcasting Company, WINX, Traffic Dir/Engineer
|
| voice: (301)424-9292 Packet: KA3PGN@WA3ZNW / / || || \ // AM 1600 |
| "Top 40 AM Radio Still Lives!" AM 1600 || | // \ |
| UUCP: ....uunet!media! "Playing 40 Years of Top 40" |
```



Subject: MODS for KENWOOD TS-930 Transcievers =====

The following is a list of favorite changes that can be made to the Kenwood 930. These changes are quite simple and do not require the addition of any switches.

NOTE: In the operator's manual supplied with the 930, there is an error on one of the drawings. On the upper left corner of the DIGITAL UNIT schematic locate connector 8. The lead designations are as follows (note that some of the designations do not appear on this sheet so you can add them to the drawing):

| Pin | Desig. |
|-----|--------|
| 1   | 100    |
| 2   | MU     |
| 3   | SCN    |
| 4   | M2     |
| 5   | MIN    |
| 6   | FSK    |
| 7   | B2     |
| 8   | FT     |

On the main drawing, called SCHEMATIC DIAGRAM, the pin numbers shown on connector 8 are reversed from the way they are numbered on the DIGITAL UNIT schematic. In the following changes, I am assuming that the numbering on the DIGITAL UNIT sheet is correct. In any event, it will be obvious which end is which since the end pin is vacant.

#### CHANGES

1) The resolution of the main tuning digital readout can be increased from 100 Hz to 10 Hz. No digits are lost since the readout has the extra digit for this purpose. This change is accomplished by grounding pin 1 of connector 8 on the DIGITAL UNIT.

2) The tuning rate is 10 kHz per revolution of the main tuning knob. The tuning rate can be changed to 5 kHz per revolution by cutting one end of diode D-13 on the DIGITAL UNIT.

(Note that the black marks on the tuning knob itself are exactly 500 Hz apart. The knob can be "corrected" by tuning in an exact frequency, for example 10,000.00 kHz, pressing the DIAL LOCK switch, then turning the knob to line up a black line. As long as you don't spin the dial too fast, it will track nicely from one end to the other. With the slow rate modification, the dial increments become 250 Hz per division).

You may desire to switch this reduced tuning rate on and off. For example, you can select the new rate on just VFO B by using an unused section of the "FUNCTION" switch. Another possibility is to use the display "DIM" switch.

3) There are an additional 8 memories available. These can be obtained by grounding pin 5 of connector 7 on the DIGITAL UNIT. (This lead is designated "M3").

The 8 additional memories can be selected by using an unused contact on



the "FUNCTION" switch.

4) Each group of 8 memories can be scanned at a rate of about 1 per second. Unlike a normal scanner, The unit will not stop scanning when a signal is present, but it is a good way to search favorite frequencies for activity.

A method of turning on the scan function without affecting normal switch functions would be to wire the unused section of the DIAL LOCK switch in series with the unused section of the METER switch (meter switch in the "VC" position).

5) A handy option is to be able to momentarily unlock one VFO when the DIAL LOCK is on. This can be useful during split frequency operation when you want to keep the receive vfo locked (the DX station's xmit freq), yet quickly qsy to the frequency he is listening to with your transmit VFO.

This change can be made by wiring one lead from the DIAL LOCK switch in series with extra normally closed contacts of the "T-F" switch.

6) This change permits automatic disabling of a linear amplifier during full break-in cw operation. This is desirable since the relays in a linear cannot properly follow each keyed character element. This change should also be done if AMTOR operation is contemplated.

Assuming that your 930 has the aux. relay board in it, merely wire the +28 volt lead to the relay coil in series with the extra contacts of the "FULL-SEMI" switch.

7) For AMTOR operation, the T-R switching speed must be increased.

2 suggested changes are to remove C-500 (4.7uf) on the SIGNAL BOARD (located top center near connector 30), and to ground the junction of R-476 / Q-100.

8) In early units, the WARC band transmit was not enabled. If this is the case, solder a jumpe from pin 12 of IC-23 to ground on the DIGITAL UNIT. (Ground can be obtained at pin 8 of IC-24).

9) Transmit can be enabled on all frequencies between 1.5 and 30 MHz for MARS and transverter use by adding two jumpers on the DIGITAL UNIT:

Connect pin 9 of IC-11 to pin 12 of IC-21.

Connect pin 9 of IC-12 to pin 12 of IC-22.

=====  
Additional comments:

Even though the receiver low frequency end is spec'd as 150 kHz, it will operate own to 100 kHz. [A[BTo conveniently switch in a general purpose receiving antenna you must use the transverter connector. When the 8 pin DIN plug is plugged into this connector, a switch operates which separates the coaxial antenna input from the receiver input. These two connections appear at pins 8 and 5 resp. of the transverter connector. (This 8 pin DIN plug is not furnished with the 930). The most convenient setup is to bring cables from both the REMOTE and TRANSVERTER connectors into a junction box which has appropriate connectors and

switches on it for interfacing to a transverter, receiving antenna, linear amp, etc.

Here is a chart of the connections to these connectors:

| REMOTE (7 pin DIN) | XVERTER (8 pin DIN)      |
|--------------------|--------------------------|
| 1 Speaker output   | 1 Grd                    |
| 2 Grd              | 2 +V out on xmit*        |
| 3 PTT              | 3 Grd                    |
| 4 Q-22 out**       | 4 XVRT ON/OFF Control*** |
| 5 unused           | 5 Receiver input         |
| 6 ALC input        | 6 XVRTR ALC input        |
| 7 XMIT RELAY**     | 7 Xmit RF to xvrtr input |
|                    | 8 HF ant in              |

\* A 12 volt, 50ma max. relay may be connected from pin 2 to ground. This relay will operate on xmit.

\*\* Original units used Q-22 collector for linear amp relay control. This did not work with low voltage relay systems or those using a negative voltage. An optional relay board (Now supplied in all units as standard) is aivable and provides a normally open contact closure to ground at pin 7.

\*\*\* Pin 4 is grounded to enable xvrtr operation. This may be done by a switch in the transverter itself.

=====  
\*\*\*->Be careful not to transmit out-of-band, or accidentally operate on any non-amateur, unless you are authorized to do so.

DO NOT JEOPARDIZE YOUR LICENSE!

From: wa2ise@cbnewsb.cb.att.com (robert.f.casey)  
#Subject: TS930 repair notes (long)  
Message-ID: <1991Dec18.182424.25084@cbfsb.att.com>  
Keywords: ts930  
Sender: news@cbfsb.att.com  
Organization: AT&T Bell Laboratories  
Date: Wed, 18 Dec 1991 18:24:24 GMT  
Lines: 254

the following is a series of packet articles on the TS930

| Msg# | TSF | Size | #Rd | Date   | Time | From  | MsgID        | To             |
|------|-----|------|-----|--------|------|-------|--------------|----------------|
| 379  | BF  | 914  | 0   | 15-Dec | 1708 | KD2EJ | 29228_WB2QJA | INFO@ALLBBS () |

Sb: TS-930S CW PITCH TONE

PERMISSION GRANTED FOR RELAYING AS INDICATED ON KENWOOD BBS.

SB-872

TS-930S CW Pitch Tone Shift

7-06-83

Some users of the TS-930S have reported a slight change in the CW pitch tone when the MONI switch is turned ON and OFF.

This may be corrected by changing the following components:

On the Signal unit (X57-1000-XX) change R826 from a 1 K ohm resistor to a 10 K ohm resistor and remove C601, a .022uF capacitor from the foil side of the circuit board.

Notes: This change is applicable to units before serial number 3070221 only.

Time required for this change is 1/2 hour.

CLM

(c) 121589TKC

| Msg# | TSF | Size | #Rd | Date   | Time | From  | MsgID        | To             |
|------|-----|------|-----|--------|------|-------|--------------|----------------|
| 382  | BF  | 828  | 0   | 15-Dec | 1717 | KD2EJ | 29231_WB2QJA | INFO@ALLBBS () |

Sb: TS-930 15M INTERNAL BEAT TONE.

PERMISSION GRANTED FOR RELAYING AS INDICATED ON KENWOOD BBS.

SB-884

TS-930S 15 Meter Internal Beat Tone

1-27-84

Some users have reported an internal beat tone that appears every 10 KHz , when operating in the range of 20.000 to 21.500 MHz. Apparently the RV terminal of Switch Unit H is being affected by the 1st loop of the PLL unit. The cure is relatively simple. Add a .01uF 50v Disk ceramic capacitor from the RV terminal to ground.

CLM

Time required for this modification is 1/2 hour or less.

(c) 121589TKC

| Msg# | TSF | Size | #Rd | Date   | Time | From  | MsgID        | To             |
|------|-----|------|-----|--------|------|-------|--------------|----------------|
| 383  | BF  | 2392 | 0   | 15-Dec | 1720 | KD2EJ | 29232_WB2QJA | INFO@ALLBBS () |

Sb: TS-930S INTERMITTENT TX PWR OUT.

PERMISSION GRANTED FOR RELAYING AS INDICATED ON KENWOOD BBS.

SB-886

TS-930S Intermittent TX Power Output

5-11-84

The following procedure should correct any tendency of the TS-930S to exhibit intermittent TX power output. Most of the reported cases of this nature have been traced to poor contact of one or more plated thru holes

mentioned below. Careful adherence to this procedure should prevent reoccurrence of this symptom.

Procdeure:

1. Remove the top and bottom covers.
  2. Remove the 10 screws securing the final unit to the chassis.
  3. Disconnect all cable assemblies from the final assembly, and remove it from the radio. The fan motor cable may have to be removed for easy access.
  4. Remove all Final Unit PC board screws and turn the circuit board foil side up.
  5. Desolder Q6, D2, and the plated-thru hole connecting the foils from R20 and Q8 base together (between T2 and VR1). Do not remove the components!
  6. Carefully remove the green solder resistant coating from the immediate areas of these six points, so that there is bare copper foill up to and surrounding the eyelets.
  7. Carefully resolder these six points, and those listed below:
    - Q1 Emitter and base
    - D4 anode and cathode
    - Q2 Emitter and base
    - Q3 Emitter and Base
    - Q7 Emitter and Base
    - Q4 and Q5 Base and collectors
- Plated-thru hole between C36 and C15
- (2) Plated-thru hole sby the molex connector.
- Check and resolder the input and output coax connectors.
8. Double check your work to ensure that there are no solder bridges or splashes.
  9. Check the value of R19. If it is not 6.8 K ohms, change it so it is.
  10. Reinstall the final assembly, and readjust the idle bias currents of the driver and final transistors in accordance with Service Bulletin 867.

CAUTION: ENSURE THAT NO CABLES ARE PINCHED BETWEEN THE FINAL ASSEMBLY AND CHASSIS WHEN REINSTALLING THE FINAL UNIT. THE FAN CABLE IS ESPECIALLY VULNERABLE, SO PAY CLOSE ATTENTION!

Time required for this modification is 1 hour or less.

(c) 121589TKC

```
Msg# TSF Size #Rd Date Time From MsgID To
 378 BF 1294 0 15-Dec 1706 KD2EJ 29227_WB2QJA INFO@ALLBBS ()
Sb: TS-930S PLL UNLOCK
```

PERMISSION GRANTED FOR RELAYING AS INDICATED ON KENWOOD BBS.

SB-869

TS-930S PLL Unlock

3-29-83

Some users of the TS-930S have reported a problem where the PLL will sometimes not lock (digital display does not come on) if the power switch is turned off and on while xx.499.9 MHz is displayed, after the unit has

warmed up. This may occur also in the FSK mode.

This may be caused by detuning of VCO-2 and VCO3 in the PLL unit (X50-1880-00). This may be cured by a simple increase in the voltage obtained in the PLL alignment procedure. Make the following change in your service manual.

Service Manual page 58.

3. VCO-3 T14 change 3.7v to read 4.2 vdc
4. VCO-2 T15 change 3.0v to read 3.5 vdc

Notes: 1. Be sure to adjust T14 and T15 of VCO-2 and VCO3 whenever a PLL related circuit is serviced.

2. This change applies to units before S/N 306XXXX.

3. Installation time for this change is 1/2 hour or less.

JEB/sh

(c) 121589TKC

```
Msg# TSF Size #Rd Date Time From MsgID To
 380 BF 901 0 15-Dec 1710 KD2EJ 29229_WB2QJA INFO@ALLBBS ()
Sb: TS-930S RF FEEDBACK
```

PERMISSION GRANTED FOR RELAYING AS INDICATED ON KENWOOD BBS.

SB-874

TS-930S RF Feedback

7-15-83

For reports of RF feedback from the external speaker, especially when using a vertical antenna, or a linear amplifier, check for correct installation of capacitor C16 on the EXT SPKR jack.

C16 should go from ground to the white wire on the opposite side of the jack. Some units have the capacitor soldered to the middle terminal in error!

Note: This bulletin is applicable to radios with serial numbers prior to 3070420.

Time required for this change is 1/2 hour.

CLM

(c) 121589TKC

```
Msg# TSF Size #Rd Date Time From MsgID To
 377 BF 840 0 15-Dec 1703 KD2EJ 29226_WB2QJA INFO@ALLBBS ()
Sb: TS-930S SSB TX TONE QUALITY
```

PERMISSION GRANTED FOR RELAYING AS INDICATED ON KENWOOD BBS.

SB-867

The transmitted audio tonal quality of the TS-930S may be improved by the following procedure:

In the TS-930S Service Manual page 64, make the following change:

5. 100 W Final Bias VR2 adjust for 70 ma  
VR1 adjust for 1.3A

Note: This change is applicable to units with serial numbers prior to S/N 3080001.

Installation time for the procedure is 1/2 hour or less.

JEB/sh  
(c) 121589TKC

```
Msg# TSF Size #Rd Date Time From MsgID To
381 BF 1385 0 15-Dec 1713 KD2EJ 29230_WB2QJA INFO@ALLBBS ()
Sb: TS-930S SERVICE NOTES ON AT.
```

PERMISSION GRANTED FOR RELAYING AS INDICATED ON KENWOOD BBS.

SB-877

TS-930S Service Notes on AT-930

8-23-83

Some of the symptoms and cures for troubles that have been encountered with the AT-930 are listed below.

1. The motors do not stop on all bands.

Possible causes:

- a. Cold solder joint of platee VCJ wire.
- b. Cold solder joint of L18 lead.
- c. Cold solder joint of the wire between pin 13 of Q39 and R139, D33 and R138.

2. The motors do not stop on the 7 MHz band.

Possible Cause:

The rotor of VC2 contacts (shorts against) the stator.

3. The motors do not stop on the 28 MHz band.

Possible Cause:

Cold solder joint between D33 and R84

4. The AUTO mode does not reset.

Possible Cause:

The wire from R138, R139 and D33 may touch Q39 pin 14.

5. The motor stop when SWR is at Maximum.

Possible Cause:

The wire from R138, R139 and D33 touches Q39 pin 14 and the foil is broken around VC1.

Time required for this change is 1/2 hour.

CLM

(c) 121589TKC

=====  
Note: I haven't tried or verified this, proceed at your own risk. WA2ISE





From: wa2ise@cbnewsb.cb.att.com (robert.f.casey)  
Newsgroups: rec.radio.amateur.misc  
Subject: TS940s erratic display or control fix  
Keywords: ts940  
Message-ID: <1991Dec8.192345.28337@cbfsb.att.com>  
Date: 8 Dec 91 19:23:45 GMT  
Sender: news@cbfsb.att.com  
Organization: AT&T Bell Laboratories  
Lines: 95

copied from packet:

| Msg# | TSF | Size | #Rd | Date   | Time | From  | MsgID        | To             |
|------|-----|------|-----|--------|------|-------|--------------|----------------|
| 8594 | BF  | 3105 | 0   | 01-Dec | 2326 | KD2EJ | 27873_WB2QJA | INFO@ALLBBS () |

Sb: TS-940 ERATIC DISPLAY INFO.

SB-951  
TS-940S ERRATIC D 01/20/89

Intermittent control or display problems that are difficult to correct with the reset procedure may be caused by a faulty ROM socket. The socket should be checked to insure that it makes good electrical contact with each pin of the ROM. If it is found to be intermittent, remove the socket and solder the ROM directly to the board. It should be noted that units between serial numbers 701XXXX to 811XXXX and from 903XXXX to 909XXXX are not likely to have this failure. In addition, units with a serial number of 909XXXX and above do not incorporate a socket.

#### CAUTION

Removing the socket requires good soldering skills. The ROM is mounted on the Digital A unit and is designated as IC2. The board, being double sided, has solder connections on both component and foil sides. When the socket is removed, it is very important to insure that each pin is completely solder free. Having to pry up on the socket means that it is not completely desoldered and will cause the circuit foils to tear.

When performing any work on the Digital A board, CMOS handling techniques must be observed. Such techniques include using a grounded or isolated soldering tip, avoid touching the pins of IC chips with your fingers, and ground yourself with a wrist ground strap.

To remove the socket:

1Disconnect the power cord and antenna coax.

2Remove the top and bottom covers from the transceiver.

- 3 Remove the 2 flat head screws from each side of the front panel chassis.
- 4 Loosen the round head screw on each side of the front panel chassis.
- 5 Carefully rotate the front panel forward. It will be necessary to unplug the VS-1 cable from the transceiver.
- 6 Remove the 4 screws from the speaker mount.
- 7 Carefully pull up on the mount and rotate it toward the front panel. Swing the mount toward the right side of the transceiver and allow it to rest on the Digital B unit shield.
- 8 Remove the 8 screws from the Digital A unit shield plate.
- 9 Lift the plate and rotate it to the left side of the transceiver.
- 10 While avoiding contact with the pins, remove the ROM (IC2) and set it aside on anti-static foam.
- 11 Remove the 6 screws that mount the Digital A board. Rotate the board toward the front panel to expose the bottom side of the board.
- 12 Carefully desolder the socket and remove it from the board. Do not pry up on the socket. If it does not easily pull off the board, the top foils are still soldered to the socket.
- 13 Install the ROM in the board and solder it in place.
- 14 Assemble the transceiver by reversing steps 1 - 11. Do not pinch the power switch cables between the front panel and the body of the transceiver.  
Time required for this modification is 1.5 hrs or less. (C)  
011189TKC

=====  
Note: you might find it easier to break apart the plastic of the socket and remove the pins one by one. And/Or use a better grade of socket.  
Try just removing and reinserting the Rom in its socket to see if this fixes the problem before you go to all this trouble. This might clean a dirty socket contact.      Anyway....  
I haven't tried or verified this, proceed at your own risk. WA2ISE



From: VK3YZW@VK3YZW  
To: ALL  
Subject: TS-940 Control Program  
HI,

THIS PROGRAM WAS A RESULT OF A PRIVATE REQUEST AND IS NOW PUT  
ON THE BBS FOR ALL TO USE WHO MAY LIKE TO TAKE ADVANTAGE.

GOOD LUCK WITH IT....DON

Here below is a program that can control the TS940 to run under IBM XT.  
The program is written by JA6FTL and his group.  
The program is being used by JA6FTL and no bug report was found!  
Good Luck, 73

Eric VS6EL @ VS6EL

```
; *****  
;          TS-940 remote control programm for IBM-PC/AT/XT  
;          1988/05      Southern NET  
;  MBBIOS and MBMODE must be run before execute.  
;  Com port 1-6(A-F) allowed.  
;  Usage..... 940set_(port)_(parameter)(parameter)...  
;  example          940set a FA00014073000;MD1;  
; *****
```

```
NUL      = 00h  
TAB      = 09h  
CR       = 0dh  
LF       = 0ah  
BEEP     = 07h  
error    = 1  
noerror  = 0
```

```
print    macro string
```

```
    mov     ax,data  
    mov     ds,ax  
    lea    dx,string  
    mov     ah,09h  
    int    21h  
endm
```

```
putch    macro      ch
```

```
    mov     dl,ch  
    mov     ah,02h  
    int    21h  
endm
```

```
mg       group      code,data
```

```
data     segment
```

```
no_cn    db          BEEP,"Not channel [A-F]$",CR,LF
```

```
cmd_e_msg db          BEEP,"ommand error .Usage (channel)  
(parameter)",CR,LF,"$"
```

```
no_bios  db          BEEP,"Not loadedMBBIOS.$"
```

```
data     ends
```

```
cod      segment
```

```

        assume      cs:code;ds:code
        org        81h
channel  label      byte
        org        82h
cmdline  label      byte
start:
        org        100h
main     proc       near

        call       bios_chk      ; com bios exit ?

        modi,offset channel
argument:mov al,[di]
        cmp        al,CR
        je         cmd_error     ;command error
        cmp        al,' '
        jne        port
        add        di,1
        loop       argument

port:
        push       ds
        call       chk_ch        ;channel check
        sub        al,'A'        ; get port idn
        mov        ah,0
        mov        bx,ax         ; CX is port idn
        pop        ds
        mov        di,offset cmdline
        add        di,2

get_cm
        mov        al,[di]
        add        di,1
        cmp        al,CR
        jz         e_p           ;end
        cmp        al,' '
        jz         get_cmd      ; skip space
        call       toupr
        call       outi
        loop       get_cmd

extprog:mov al,0
        mov        ah,4ch
        int        21h

cmd_error:
        print      cmd_e_msg
        jmp        end_p

chk_ch:
        call       toupr        ;channel is A-F ?
        call       toupr        ; to upper
        cmp        al,'A'
        jl         no_cn_msg
        cmp        al,'G'
        jg         no_cn_msg
        ret

toupr:
        cmp        al,'Z'
        jl         not_mall
        sub        al,20h

not_small:

```

```

no_cn_msg:    ret
              ;no channel msg
end_p:        print    no_cn
              mov     al,0                ; nomal end
              mov     ah,4ch
              int     21h
bios_chk:     mov     dx,00
              mov     ah,04
              int     14h
              cmp     a0aa55h
              jne    exit                ; bios no loaded
              ret
exit:         print    no_bio
              jmp     end_p
outi:        push    bx
              xor     dx,dx
              mov     dx,bx                ; load port_idn
              mov     ah,01h              ; sirial out cmd for int 14
              int     14h
              pop     bx
              ret
main         endp
code         ends
end         main

```



Newsgroups: rec.radio.amateur.misc  
From: keithm@wicat.com (Keith McQueen)  
Subject: Mod for Kenwood TW-4000 for CAP  
Message-ID: <1992Nov6.173126.8068@wicat.com>  
Summary: CAP mod for Kenwood TW-4000  
Keywords: mod, tw-4000  
Organization: WICAT Systems  
Date: Fri, 6 Nov 1992 17:31:26 GMT  
Lines: 20

I tried to e-mail the gent who needed the mod for the Kenwood TW-4000 for CAP for his friend. I bounced with unknown host. Since mods are fairly general interest anyway, I decided to just post it.

-----  
On the back of the CPU assembly, (part of the front panel assembly), there is a wire jumper (sort of a loop of wire between two pads on the board). If you clip this wire, and reset the CPU, the '4000 will RX-TX from 141.0 Mhz to 150.995 Mhz. There is no change on UHF.

Let me know if this helps.

--

|                                                   |                 |
|---------------------------------------------------|-----------------|
| Keith McQueen, Wicat Systems Inc. , (801)224-6400 | My opinions are |
| Packet: n7hmf @ nv7v.UT.USA.NA                    | all mine...     |
| Internet: keithm@wicat.com                        | ...so there!    |





Date: 9 Oct 89 13:37:06 GMT

Subject: Extended xmit mod for the Icom IC-u2AT handheld

Extended TX mod for the Icom IC-u2AT

This mod will extend the transmit range of the u2AT from 139 Mhz to about 161 Mhz (maybe further if you adjust the PLL). You'll be working with a surface mount PCB, so you will need a fine point soldering iron and a very steady hand. And you will need one diode, like a 1N914, or a tinyier one if you can get it.

You must have the service manual to help you identify where the new diode is to go. Review all the below with the manual before you reach for your screwdriver and soldering iron!

>remove the battery pack.

>remove 4 screws that hold the sliding guide that the battery pack mounts on. This is the piece of metal that frames the PL tone switches.

>remove the sliding guide. Be careful that you don't lose the battery release button.

>there's a screw on the left side of the HT just below the light switch. Remove it.

>CAREFULLY pry the front panel up. There's speaker wires AND a flexable lead that goes to the front panel.

>There's a shielded PCB that these leads run to. Carefully pry this up. It will then fold down. There's several flexable leads at the bottom.

>You should see the CPU now.

With the manual, locate where D113, D119, Q131 are.

>Where the new diode goes is not marked in the diagram of the CPU PCB. Locate the anodes of D119. This land connects to pin 27 of the CPU chip ic101. Locate the cathode of D113. This land connects to pin 20 of the CPU chip. These diodes are SMDs, and do not look like what you'd expect diodes to look like.

>In the area between Q131, D119, D113, and the CPU chip, you should see a set of 3 solder pads that form a trianglular pattern that would accept a 3 legged SMD, like the neighboring diodes and transistors. One of these pads connects to the anodes of D119. The new diode's anode goes to this pad. Another pad connects to the cathode of D113. The cathode of the new diode goes here. This means that the new diode cathode will connect to pin 20 of the CPU, and that the anode will connect to pin 27 of the CPU.

>Carefully prepare the diode leads to line up with the proper pads, and take care that when you solder it on, you don't short to something. Also, take anti-static precautions. I used a bit of double-sticky-foam tape to hold the diode in place when I soldered it. And I left the tape to help keep it in place after I was done. Be sure that you will be able to replace the PCB you pried up, without it touching the diode.

>Reassemble the rig.

>Do a CPU reset. That is: Turn the power on while holding the light switch down.

>You should be able to xmit between 139 to about 160 Mhz. You could tweak the PLL to extend it further, but I didn't do this. The xmit power will be lower on the higher freqs.

Disclaimers: Be sure to have the proper permits for out of band operations. And, do this mod at your own risk! WA2ISE

73s

3100 Ocean Park Blvd. (213) 450-9111, ext. 2973 +-----+  
Santa Monica, CA 90405 [csun,philabs,randvax,trwrb]!ttidca!ttidcb!sorgatz \*\*



Date: 19 May 90 04:02:23 GMT  
From: philmtl!philabs!briar!rfc@uunet.uu.net (Robert Casey)  
Subject: Mod file: Uniden 2510 AGC speed mod for packet  
To: packet-radio@ucsd.edu

copied from packet:

| Msg#  | TSF | Size | #Rd | Date/Time | MsgID       | From   | To            |
|-------|-----|------|-----|-----------|-------------|--------|---------------|
| 26389 | BF  | 1878 | 1   | 0508/1111 | 6894_TI3DJT | TI3DJT | MODS@NYNET () |

Sb: speeding up Uniden 2510 AGC

For those of you who are using a Uniden 2510 for packet, you can speed up AGC speed considerably, just by removing the AGC SSB switch transistor Q-111 This transistor switches the AGC off for CW operation, and on for SSB operation. All I did was remove it and my radio now works with very good speed on 10m. You may put a switch between the pads that were for collector and ground. When you want slow AGC turn the switch ON pulling line to ground. For fast agc turn switch off leaving line floating. That is all there is to it.

The description of the mod for the 2510 may work for the 2600. Those who have the Uniden 2600 may find that the AGC is the same for this radio. Look for NJM2902 IC (this is the AGC amp), you may find a transistor connected thru a RC network, to pin 12 of said ic. Remove also. (this mod not tested!)

Ciao de Chuck ti3djt @ ti0paq.cri.na

-----  
Note: I haven't tried or verified this, proceed at your own risk! WA2ISE  
A notice found on a piece of test equipment made in Japan:  
"IT PUT ON THE VINYL SHEET ON THE SURFACE OF UPPER & LOWER PANEL FOR THE  
PROTECTION PLEASE USE AFTER TEAR OFF VINYL SHEET WHEN USING.  
-----



